



infrastructure  
protection

protection  
infrastructure

TZ Praetorian™ System



infrastructure  
protection

protection  
infrastructure

TZ Praetorian™ System

Model Numbers: 7140AF/7141AF and 8108AF

## About TZ

Telezygology, Inc. (TZ) is a wholly owned subsidiary of publicly listed intellectual property and technology development company, TZ Limited, with design and engineering operations throughout the US and Europe and Australia.

TZ is a leader in the integration of intelligence and software control into everyday objects to enable new levels of functionality. Supported by a full product development capability, TZ Technology is a platform on which many different solutions can be created by third parties seeking to integrate remote controlled intelligent locking and sensory devices to add functionality to their products.

TZ solutions fuse software controlled remote locking and fastening, environmental sensing, real time analysis and measurement to provide adopters with compelling benefits for their products and businesses.

TZPraetorian™, TZSlideHandle™, TZRadial™ and TZSMArt™ are trademarks of Telezygology Inc. Patents Pending.

## Use of Information Contained in This Document

The correct functions of the TZ Praetorian system will require consideration of installation and system integration issues such as networking for power and data and subsequent programming for functionality.

The TZ Praetorian™ system described has not been tested or qualified for a specific application other than for compliance to the specification outlined. Specific qualification testing may be required for fit-for-purpose application design.

## Caution

Changes or modifications not expressly approved by TZ could void the user's authority to operate the equipment (FCC Code of Federal Regulations Title 47 Part 15.21).

## Disclaimer

This document is intended to provide an overview for the set-up and basic operation of the TZ Praetorian™ System.

This document is not meant to be an exhaustive statement of all relevant data. By using this document, however, you agree to accept and comply with the terms, conditions, notices and disclaimer contained in this document.

While TZ has used all due care and skill to ensure that the information contained in this document is accurate, correct, and current at the time of publication, it does not warrant or represent that the information is free from errors or omissions, and does not accept responsibility for any defect in the information.



## Contents

<b>1. Tz Praetorian™ System</b>	<b>1</b>
1.1. Introduction	1
1.2. System Overview	1
1.3. Electronic Capabilities	2
<b>2. Sytem Components</b>	<b>3</b>
<b>3. Cabling Protocols</b>	<b>4</b>
<b>4. Operation &amp; Wiring</b>	<b>4</b>
<b>5. System Operation And Requirements</b>	<b>5</b>
5.1. TZ Praetorian™ Junction	7
5.2. TZ Praetorian™ Trigger	7
5.3. TZ SlideHandle™ Operation	8
5.4. Infrastructure Requirements	9
5.5. Quantities, Layout and Planning	10
<b>6. Mounting &amp; Installation</b>	<b>10</b>
6.1. TZ Praetorian™ Junction Mounting	10
6.2. Cable Installation	13
6.2.1. TZ Praetorian™ Junction Back Panel Connections	14
6.2.2. TZ Praetorian™ Junction Front Panel Connections	15
6.3. Control System Provisioning	16
6.4. Install Validation Procedures	16
6.5. TZ Praetorian™ Trigger Mounting	20
<b>7. Troubleshooting Guide</b>	<b>23</b>
Appendix 1: TZ Praetorian™ Junction Specifications	25
Appendix 2: TZ Praetorian™ Trigger Specifications	27



## 1. TZ Praetorian™ System

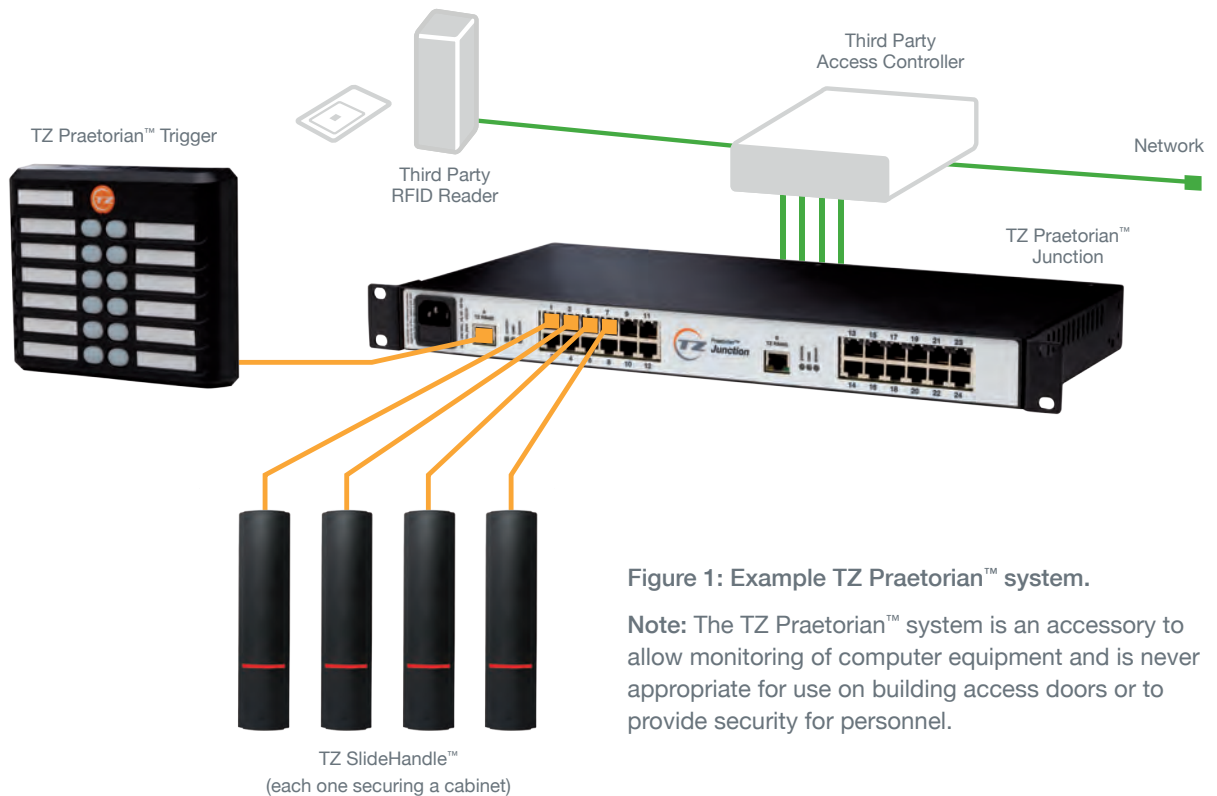

Figure 1: Example TZ Praetorian™ system.

Note: The TZ Praetorian™ system is an accessory to allow monitoring of computer equipment and is never appropriate for use on building access doors or to provide security for personnel.

### 1.1. Introduction

Telezygology, Inc. (TZ) is the inventor of intelligent fastening, locking and actuation devices that in combination with TZ software and communication gateways provide a networked platform that extends traditional access control networks to asset level protection and creates compelling security, locking, monitoring and control applications across a number of market segments.

TZ control networks consist of TZ SlideHandle™ devices and other locking devices, interconnect modules, physical and environmental sensors and industry standard access control input translators, all of which can be connected to and controlled from stand-alone control devices and computers via the Internet.

This manual only provides detailed technical information about the TZ Praetorian™ system. Please refer to the appropriate system or component manual for information on other TZ products.

### 1.2. System Overview

The TZ Praetorian™ system shown in Figure 1 is a set of accessories for existing control systems and structured cabling environments that extends access control and audit trail capability to the data center cabinet level. The system consists of TZ components expressly designed for the needs of data centers and IT professionals while bridging the gap to the physical security provided by industry standard building control systems already in place. Door status of a cabinet row or entire room is indicated at a glance on the same easily mounted component used to trigger multiple doors. The TZ Praetorian™ system includes three main types of components: TZ Praetorian™ Junctions, TZ Praetorian™ Triggers, and TZ fastening devices – such as TZ SlideHandle™ and TZ Radial™ devices.



infrastructure  
protection

protection  
infrastructure

TZ Praetorian™ System

Model Numbers: 7140AF/7141AF and 8108AF

### 1.3. Electronic Capabilities

The TZ Praetorian™ system is a set of accessories that extends existing access control systems into the specialized and much finer control of the data center. The specific functional highlights include:

- > TZ SlideHandle™ devices and other TZ SMART™ devices throughout the data center constantly monitor the status (i.e., locked, closed but accessible, open and accessed) of every enclosure.
- > The TZ Praetorian™ Junction interprets relay signals from commercial access control devices, converts to proprietary RS485 commands and forwards the commands to the appropriate TZ device using the structured cat5 cabling in a data center environment.
- > The TZ Praetorian™ Trigger displays the status of all of the locks in a row of cabinets, cages, enclosures or other meaningful groups via a set of easy-to-view LED indicators.
- > The TZ Praetorian™ Trigger also provides a convenient and easy method of opening only those enclosures that need to be opened.
- > The TZ Praetorian™ Junction communicates with all of the TZ devices and reports the status of all the locks back to the access control system to make all of the information available to the user and to keep an audit trail.



## 2. System Components

The TZ Praetorian™ System comprises the following components:

<b>TZ Components</b>	<b>Description</b>
TZ Praetorian™ Junction	<ul style="list-style-type: none"><li>&gt; Interprets relay output from enterprise access control systems and responds with the status of other system components.</li><li>&gt; Provides data communication and power to one or two TZ Praetorian™ Triggers and either 12 or 24 RJ45 ports that connects to TZ SlideHandles™ and/or other TZ Locking Devices through structured cabling.</li><li>&gt; Provides pluggable screw terminal blocks for either 12 or 24 connections to the I/O cards of access control systems.</li><li>&gt; Can be mounted in a 19" 1U rack space, wall, shelf, or anywhere else convenient to the access controller and a structured cable patch panel.</li></ul>
TZ Praetorian™ Trigger	<ul style="list-style-type: none"><li>&gt; An indicator and interface device that visually communicates the status of up to 12 doors and allows authorized users to open doors with the push of a single button.</li><li>&gt; Colored LEDs behind each button indicates the locking state of the cabinet or enclosure doors.</li></ul>
TZ SlideHandle™	<ul style="list-style-type: none"><li>&gt; An intelligent locking device that offers a drop-in replacement for legacy manual swing-handle data center cabinet locks.</li><li>&gt; Integrates a high load Shape Memory Alloy (SMA) actuated locking mechanism with touch to release option, multi-color LED status indicator, manual key over-ride, electronic door.</li><li>&gt; Powered and controlled via standard UTP Cat5e / Cat6 cabling through a TZ Praetorian™ Junction.</li></ul>
<b>Non-TZ Components</b>	<b>Description</b>
Access Controller	<ul style="list-style-type: none"><li>&gt; Control device with ability to change relay outputs and detect input changes.</li><li>&gt; This device provides the interface for setup and configuration, typically by treating the TZ locking devices like floors of an elevator.</li></ul>
Structured Cabling	<ul style="list-style-type: none"><li>&gt; Cabling interconnect system that provides RJ45 patch panels, and 100m or less separation between system devices.</li></ul>
RFID Reader	<ul style="list-style-type: none"><li>&gt; Any industry standard card reader that interacts with the Access Controller.</li></ul>
RFID Cards	<ul style="list-style-type: none"><li>&gt; Card with a unique Radio Frequency Identification, used for authorization.</li></ul>
Cabinet or Enclosure	<ul style="list-style-type: none"><li>&gt; Enclosure to be physically monitored with audit trail.</li></ul>



### 3. Cabling Protocols

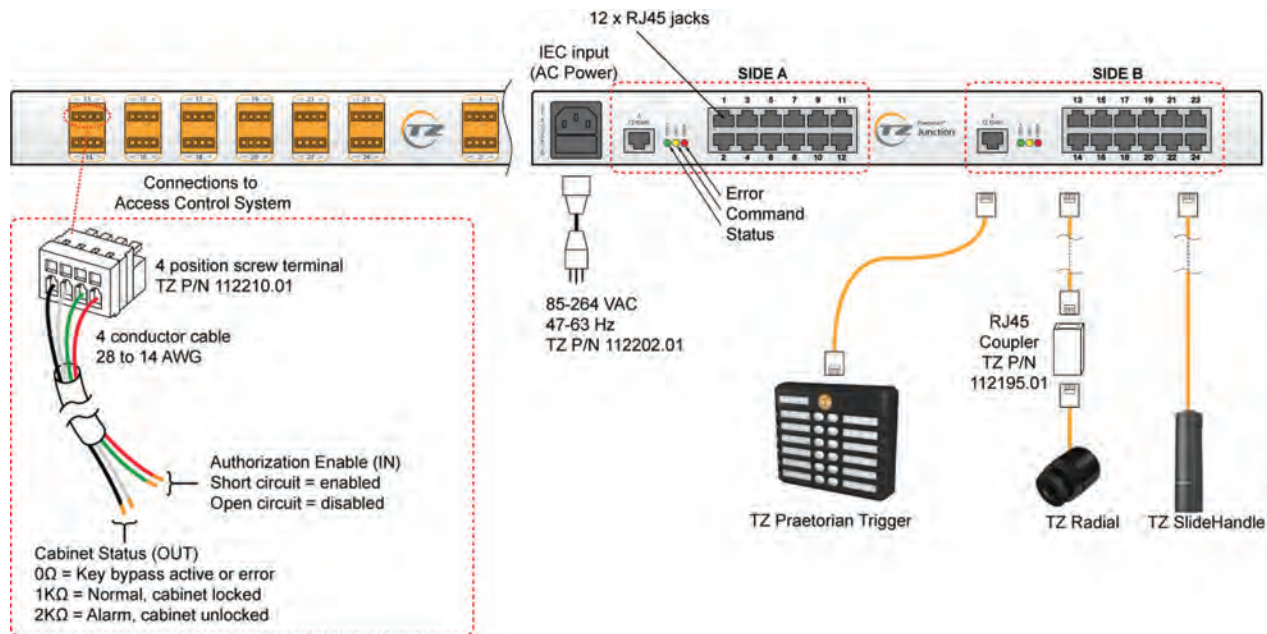

### 4. Operation and Wiring

The commercial Access Controller should be connected to at least one RFID Card Reader or other authentication device, and be set up such that each cabinet or enclosure is controlled and monitored with a 4-conductor cable. Within the four conductor cable, one pair of wires sends a relay signal, and the other pair monitors the state of the enclosure (open, closed, error) by reading a resistance value placed across a different set of wires.

The TZ Praetorian™ Junction converts the individual relay signals to a proprietary RS485 protocol along the CAT5 structured cabling, and communicates with the TZ SlideHandle™ that is connected to the corresponding RJ45

port. The TZ SlideHandle™ physically locks the cabinet, and displays the status of the cabinet (door open, lock unlocked, closed) via the LED display on its front, and communicates that status back to the TZ Praetorian™ Junction along the same RS485 protocol. The TZ Praetorian™ Junction communicates the status of each lock back to the commercial Access Controller by placing the correct resistance value across the appropriate wires.

TZ Praetorian™ Junction also connects to the TZ Praetorian™ Trigger which displays the status of all of the connected locks, and offers an additional manner of triggering specific TZ SlideHandles™ to open.



## 5. System Operation and Requirements

Consider the small, typical TZ Praetorian™ system shown previously in Figure 1. During typical use, the user presents his access card to a card reader directly connected to the controller. An animation video is also available from the TZ website. (<http://ixp.tz.net/tz-praetorian>)

The controller analyzes the ID and closes a relay for each lock the user has authorization to open. The relays ports of the access controller are wired to the TZ Praetorian™ Junction.

The TZ Praetorian™ Junction reads the status of the relays, and if the relay is closed (user is authorized), then the corresponding button on the TZ Praetorian™ Trigger as well as the indicator on the corresponding TZ SlideHandle™ start to flash orange.

The user then presses one of the flashing orange buttons, and the TZ Praetorian™ Junction then signals the corresponding TZ SMARt™ device to release, allowing the cabinet to open.

Once the TZ Praetorian™ Junction senses the door is open by reading both an open locking device and the door sensor, the button on the TZ Praetorian™ Trigger turns green to indicate the cabinet is open. At the same time, the TZ

Praetorian™ Junction changes the resistance on the status connection to the controller so that the controller knows the door is now open via electronic release.

When the door is closed and the device is locked, the corresponding button on the TZ Praetorian™ Trigger will change to red to indicate the cabinet is secure. At the same time, the TZ Praetorian™ Junction then changes the resistance on the status connection to the controller so that the controller knows the door is now closed.

The controller is typically programmed to cut authorization (open relay) after a defined time, at which time any flashing orange buttons on the TZ Praetorian™ Trigger or TZ SlideHandle™ return to the red (cabinet secure) state.









If the manual override key is ever used on a door while main power is present, the TZ Praetorian™ Trigger will indicate flashing red and the TZ Praetorian™ Junction will change the resistance on the status connection to the Controller so that a key release can be recorded in the audit trail.

The possible display states of the Praetorian™ Trigger are outlined in **Table 1**.





Table 1: Correlation between TZ SlideHandle™ status and the TZ Praetorian™ Trigger display.

TZ SlideHandle™ Status	TZ Praetorian™ Trigger Display	Description
<b>Solid Red</b> 		TZ SlideHandle™ is closed and locked. Door is closed.
<b>Solid Green</b> 		TZ SlideHandle™ is unlocked via any authorized access method through the access controller.
<b>Flashing Orange</b> 		Door is closed. The TZ SlideHandle™ is ready to be opened either by pressing the button on the trigger, or by pressing the top of the device.
<b>Flashing Red</b> 		TZ SlideHandle™ is locked with the door open or The key override has been used to unlock the TZ SlideHandle™ without utilizing the authorized access.
	<b>All Lights Flashing</b> 	Power, but no communication with the TZ Praetorian™ Junction.

If power is ever cut from the system, the doors remained locked and can only be opened via key. Events cannot be logged while power is out. The access controller handles all the authorization, logging and control functions for the system. Please consult documentation for the controller for guidance on these operations.



Figure 2: TZ Praetorian™ Junction indicators.

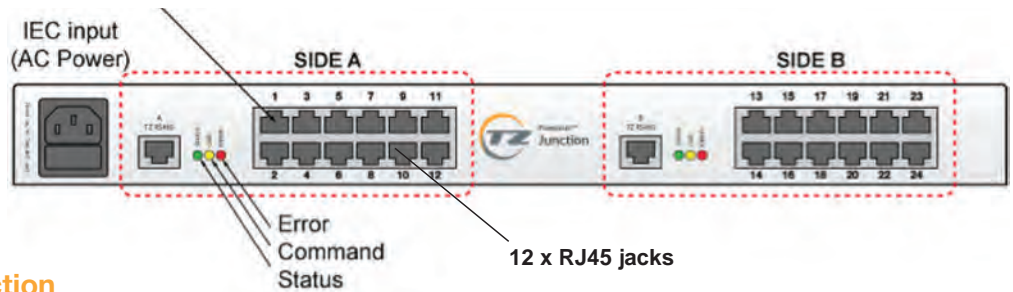

### 5.1. TZ Praetorian™ Junction

The TZ Praetorian™ Junction interprets relay signals from an access control system, forwards the appropriate command to the TZ SMARt™ device, constantly monitors all the connected TZ SMARt™ devices and communicates the status of each TZ SMARt™ device back to the access control system. The TZ Praetorian™ Junction can provide data communication and power to one or two TZ Praetorian™ Triggers and either 12 or 24 RJ45 ports that connect through structured cabling to TZ SMARt™ devices. The TZ Praetorian™ Junction also connects back to the I/O cards of the control system via either 12 or 24 (depending on the exact model) pluggable screw terminal blocks.

The LEDs on the front of the TZ Praetorian™ Junction are used to indicate system health. A blinking green STATUS LED indicates the system is functioning normally. When the system is attempting to unlock a TZ SMARt™ device, the yellow COMMAND LED will blink momentarily. If the system detects an error condition, such as a disconnected TZ Praetorian™ Trigger, the red ERROR LED will illuminate. Refer to the troubleshooting section to address the error condition.

It can be mounted in a 19" 1U rack space, wall, shelf, or anywhere else convenient to the access controller and a structured cable patch panel.

Figure 3: Front view of TZ Praetorian™ Trigger 8108AF.

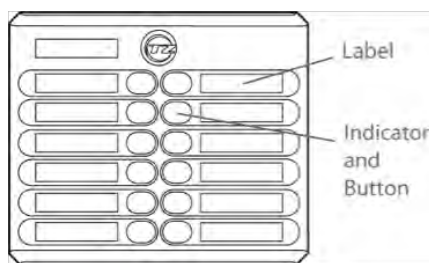
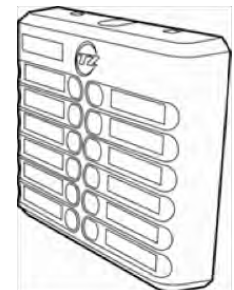

Figure 4: Isometric view of TZ Praetorian™ Trigger 8108AF.



### 5.2. TZ Praetorian™ Trigger

The TZ Praetorian™ Trigger shown in Figure 3 and Figure 4 is an indicator and interface device that visually communicates the status of up to 12 doors, and allows authorized users to open doors with the push of a single button.

Colored LEDs behind each button indicates the locking state of the cabinet or enclosure doors:

- RED** All enclosure doors are closed and secure.
- ORANGE** Flashing indicates access is currently authorized and a button push will open the enclosure. This is the only state in which a button push will have any effect.
- GREEN** The door is open or is otherwise not secure.

Each button can be labeled to correspond to the enclosure door that it is linked to and can trigger. The TZ Praetorian™ Trigger receives power and data communications from the TZ Praetorian™ Junction over standard patch cabling connections.

Typically, the device is mounted at the end of a row of cabinets or near the entrance of a room in close proximity to the card reader, but it can be mounted onto a cabinet, wall or electrical junction box in a location convenient for use and for viewing the status of all enclosures in the system.

Each button should be labelled to correspond with the enclosure door it triggers and indicates. A button push will only have effect when the button is flashing orange.

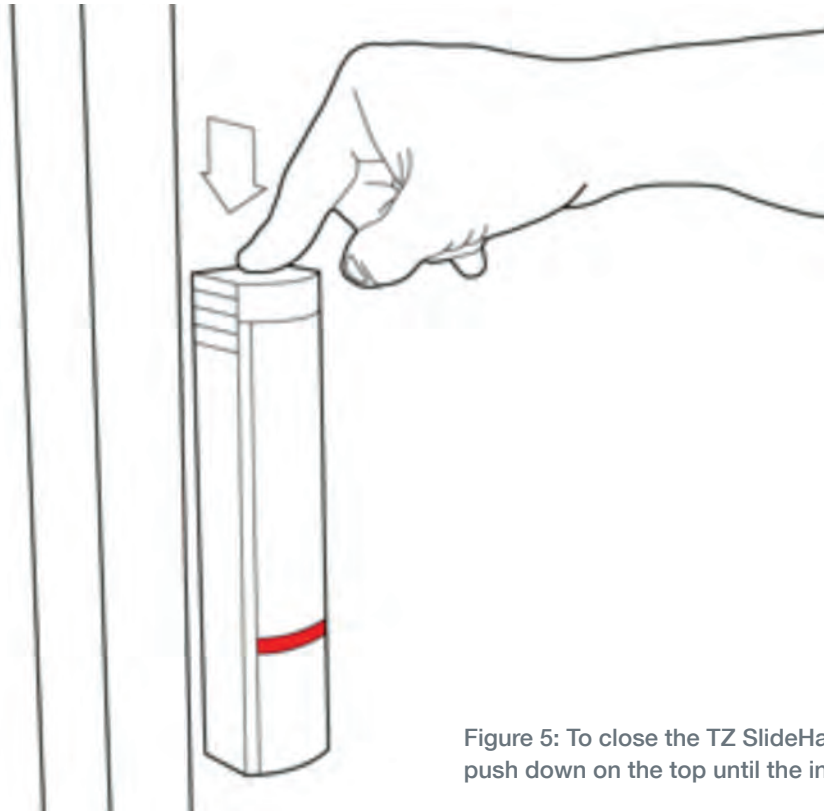

Figure 5: To close the TZ SlideHandle™, simply push down on the top until the indicator turns red.

### 5.3. TZ SlideHandle™ Operation

The TZ SlideHandle™ is the part of the TZ Praetorian™ system that performs the physical locking. It is designed to be a drop-in replacement to the industry standard handle opening typically found on IT cabinetry. The TZ SlideHandle™ provides secure latching, locking and audit trail feedback to the TZ Praetorian™ Junction, which in turn communicates with the controller. It is powered through the structured cable, with a multi-color LED status indicator, manual key override, electronic door status sensor, and RJ-45 connector integrated into the handle.

The TZ SlideHandle™ can only be placed into the unlocked state when the correct signal is sent from the controlling TZ hardware — in this case the TZ Praetorian™ Junction. When the TZ SlideHandle™ is unlocked (flashing orange), it can be

opened by pressing down briefly on the top of the handle. The top portion of the TZ SlideHandle™ will pop up, and the door will be free to swing open.

Once open, the TZ SlideHandle™ can be locked by simply shutting the door and sliding the moving top down until it clicks and the indicator light turns red, as shown in Figure 5.



To open with the key, simply insert the key into the lock cylinder in base of the TZ SlideHandle™ (as shown by key icon) and rotate it approximately 1/8 of a turn until the TZ SlideHandle™ opens. Once open (light flashing red), return key to original position and remove. The TZ SlideHandle™ will not lock, and the key cannot be removed until key is returned to original position.



### 5.4. Infrastructure Requirements

The TZ Praetorian system works with many items typically already installed in data centers. Basic descriptions of those items are outlined in Table 2.

Table 2: Infrastructure requirements and non-TZ components

Name	Icon	Description
Access Controller		Control device with ability to change relay outputs and detect input changes. This device provides the interface for setup and configuration, typically by treating the TZ locking devices like floors of an elevator.
RFID reader		Any industry standard card reader that interacts with the Access Controller.
RFID cards		Card with a unique Radio-Frequency Identification, used for control with Control components.
Patch cables	n/a	Cabling to connect system components into the Structured Cabling environment
Data Center Cabinet, Rack or enclosure	n/a	Enclosure to be physically monitored with audit trail.

The TZ Praetorian™ system relies on the ability of the user's control system to fire one or more relays when a proper authentication is presented. Each closed relay corresponds to a cabinet that has authorized access. The setup of the control system can be done by configuring an event, a global I/O, or using elevator access control. When using elevator control, each bank of cabinets would act as the elevator "car" and each cabinet lock would be a "floor". If the control system does not support elevator control, it may still be possible to configure the system using events or global I/O.

For status monitoring, the TZ system supports connections to supervised inputs of the access control system so that the open, secure, and malfunctioning states are sensed through resistance changes. Consult the manual for your access controller for specific details.

The hardware for authentication for a system must be compatible with the controller used in the system. Consult the manual for your access controller for specific details.



## 5.5. Quantities, Layout and Planning

The TZ Praetorian™ system is modular in design but there are certain requirements that must be followed when planning a system:

- > The TZ Praetorian™ Trigger is able to display the status of a group of up to 12 locks. Typically, a group is a single row, with the TZ Praetorian™ Trigger mounted on one end of the row. Also, each cabinet typically has both a front lock and a back lock. If a row has more than 12 locks (more than 6 cabinets), then additional TZ Praetorian™ Triggers will be necessary to control the additional locks.
- > A TZ Praetorian™ Junction 7140AF controls and monitors a group of up to 12 locks and a single TZ Praetorian™ Trigger. A TZ Praetorian™ Junction 7141AF controls and monitors two groups of up to 12 locks each, with a TZ Praetorian™ Trigger designated for each group.
- > The TZ Praetorian™ system requires that the overriding access control system have one relay output dedicated to each lock. It may be necessary to purchase additional controllers and/or expansion cards to complete an installation.
- > The TZ Praetorian™ system will also require additional card readers for each group of locks.
- > The exact make and model of the cabinet to be secured, as well as whether or not the installation is new or retrofit, determine the TZ SlideHandle™ part number. Please consult the TZ SlideHandle™ manual for specific details.
- > For each lock, typically one cat5 patch cable is needed to connect the TZ Praetorian™ Junction to the patch bay of the structured cabling, and one more cat5 patch cable is needed to go from the structured cabling to the TZ SlideHandle™ or TZ Radial™. The exact lengths are very dependent on the layout within the cabinets.
- > For each lock, some length of 4-conductor cable (usually 28 to 14AWG) is required to connect the controller to the appropriate port in the back of the TZ Praetorian™ Junction. The exact lengths are very dependent on the layout within the cabinets.

The specific layout within a data center will be unique, so the exact number and location of components for optimal deployment may require adjustment. Please consult a TZ salesperson for specific details.

## 6. Mounting & Installation

This manual only discusses the mounting and installation of the TZ Praetorian™ Junction and the TZ Praetorian™ Trigger. For details concerning TZ SlideHandle™, TZ Radial™ or other device, please consult the appropriate manual.

The following tools are required:

- > Philips-head screwdriver
- > Cable termination tools and crimps, if applicable
- > Wago connector operation lever or small flat head screwdriver.

### 6.1. TZ Praetorian™ Junction Mounting

The TZ Praetorian™ Junction is designed to mount in 1U of a standard 19-inch rack, a wall, a shelf, or anywhere else convenient to the location of the controller and a structured cable patch panel to reach multiple racks. The contents of the box are:

- > 1 x TZ Praetorian™ Junction
- > 12/24 x Wago 4-pin connectors (Wago p/n 734-204) (12 for model 7140AF, 24 for model 7141AF)
- > 1 x 1U rack mount brackets (hardware not included)
- > 1 x IEC power cord
- > 3 x Wago connector operation lever (Wago p/n 734-230)
- > 1 x TZ Praetorian™ System Manual

The TZ Praetorian™ Junction must be installed in an environment compatible with the ambient temperature specifications of 0°C - 50°C (32°F - 122°F). It produces some heat itself, so there must be sufficient airflow for safe operation.

The TZ Praetorian™ Junction must also be mounted in the rack such that a hazardous condition is not achieved due to uneven mechanical loading.

Consideration should be given to the connection of the equipment to the supply circuit and the effect that overloading of the circuits might have on over-current protection and supply wiring. Refer to equipment nameplate ratings and the appropriate manuals for guidance.

Reliable earthing of rack-mounted equipment must also be maintained. Particular attention should be given to supply connections other than direct connections to the branch circuit (e.g., use of power strips).

The steps for rack mounting a TZ Praetorian™ Junction are discussed in Table 3 and the steps for mounting the TZ Praetorian™ Junction to a wall or shelf are discussed in Table 4 on the following page.

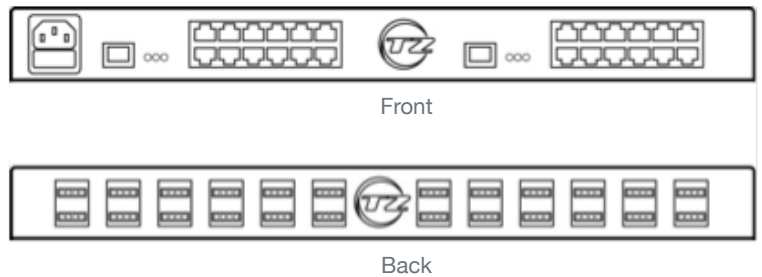

Table 3: Rack Mounting Steps

**Installation Step**

**Installation Illustration**

Step 1: Decide if the front or back of the product will face out to the user.



Step 2: Normally the front is used so the indicator LEDs can be seen. If the front will face out, go to step 4.

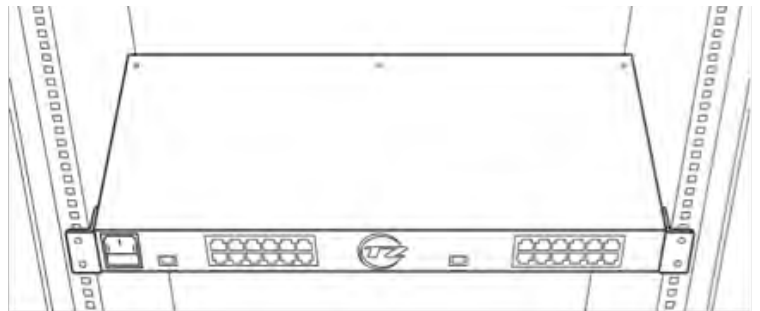

Step 3: For mounting with the back of the product facing out, move the rack mounting brackets to back of the product.

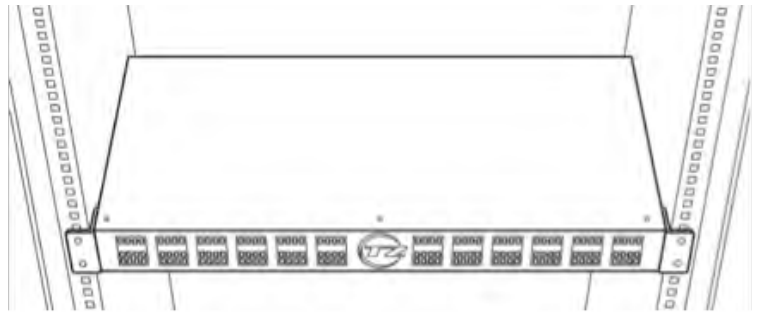

Step 4: Align the slots of the mounting rack brackets with the rail holes - use standard cage clip-on nuts and screws (not included) to fix the brackets to the rails of the rack.

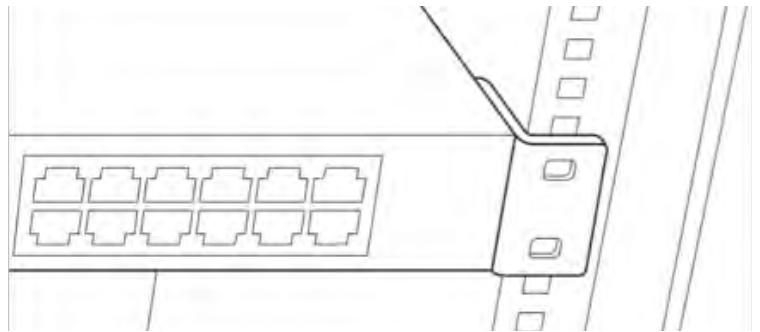

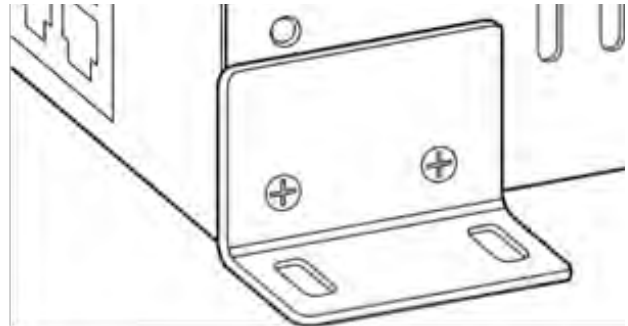

Table 4: Wall Mounting Steps

**Installation Step**

**Installation Illustration**

**Step 1:** Remove and reattach the rack mounting brackets so they are turned 90° from the default installation state and are placed in opposite corners of the product.



**Step 2:** Using proper hardware (not included) for the wall material, attach the unit using the 4 slots in the rack mounting brackets.

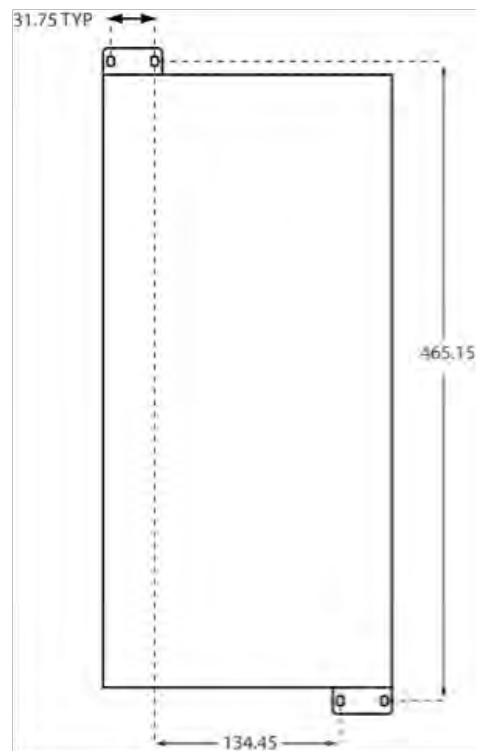



## 6.2. Cable Installation

The 12-port version of the TZ Praetorian™ Junction box supports up to 12 TZ SMARt™ locking devices, and requires one TZ Praetorian™ Trigger unit. The 24 port version of the TZ Praetorian™ Junction supports as many as 24 TZ SMARt™ devices, and uses two TZ Praetorian™ Trigger units. The 24-port TZ Praetorian™ Junction is physically divided into two identical halves, labeled “A” and “B” in the diagram below.

Each side has its own dedicated TZ Praetorian™ Trigger, and the buttons on that TZ Praetorian™ Trigger map directly to the ports of that side in a one-to-one fashion.

The connections in the back of the device are in-line with the side designations of “A” and “B” above: each 4-wire terminal block is numbered and matches with the corresponding TZ SMARt™ locking device port number on the front.

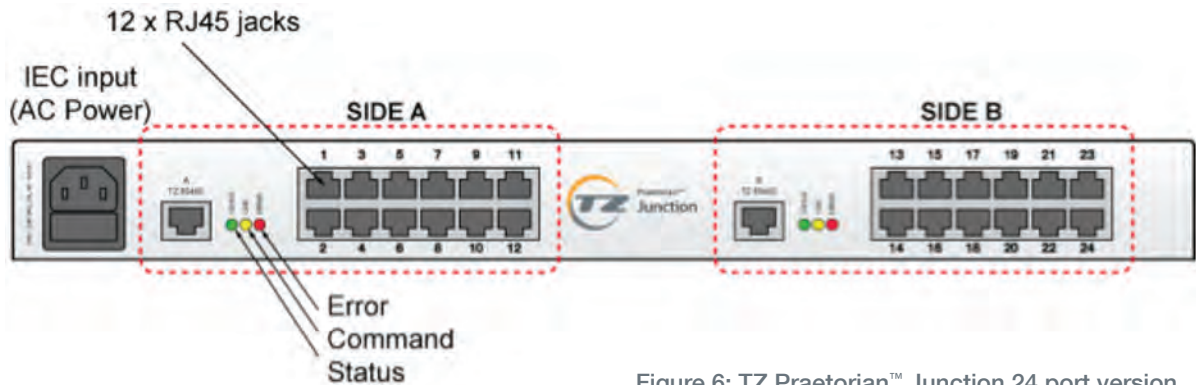

Figure 6: TZ Praetorian™ Junction 24 port version.





### 6.2.1. TZ Praetorian™ Junction Back Panel Connections

Cables must be made to connect the TZ Praetorian™ Junction to the controller. These should be four conductor cables, typically 22 or 24 AWG, with a length of no longer than 100 meters. Using the wiring diagram below, follow the subsequent steps to properly connect the TZ Praetorian™ Junction and controller.

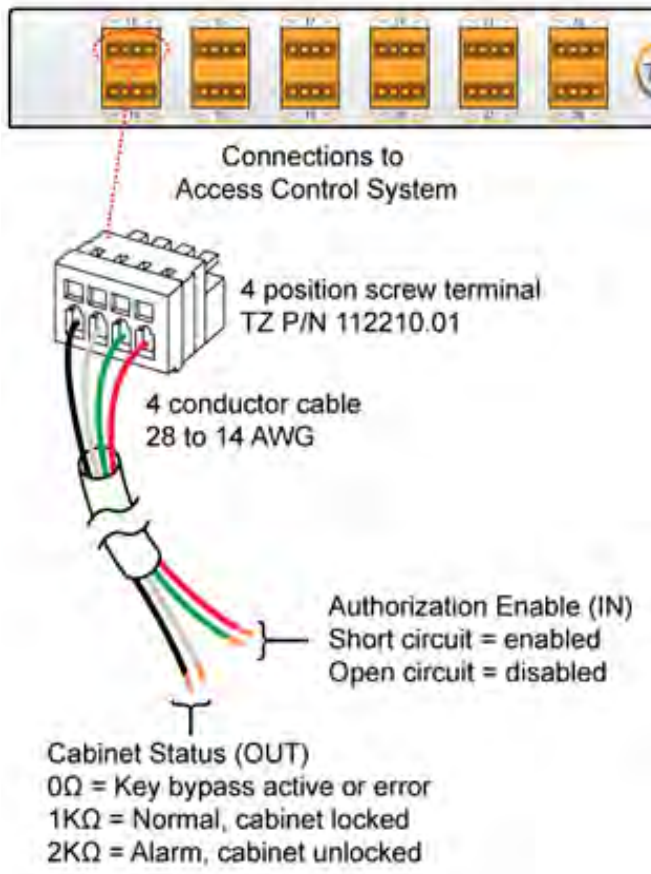

Figure 7: Wiring diagram between controller and TZ Praetorian™ Junction

Step 1: Strip both ends of the 4 conductor cable.

Step 2: Insert the supplied Wago operation levers into the Wago connectors (Figure 12) and press down to allow the insertion of a stripped wire. Release the lever to fix the wire.

Step 3: Install all 4 wires according to the wiring diagram in Figure 7.

Step 4: Terminate the remaining wires using the appropriate connectors for the Controller.

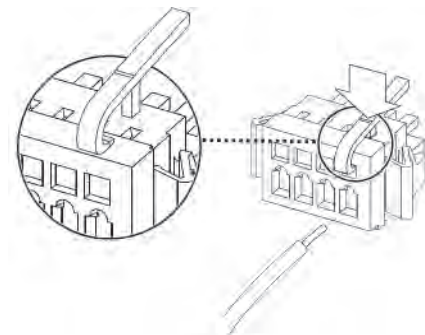

Figure 8: Use of Wago Lever



### 6.2.2. TZ Praetorian™ Junction Front Panel Connections.

Using the wiring diagram below, follow the subsequent steps to properly connect the TZ Praetorian™ Trigger, Input Power, and TZ SMARt™ locking devices to the front of the TZ Praetorian™ Junction.

**Step 1:** Connect the straight cable that was installed with each TZ Praetorian™ Trigger to the front port labeled “TZ RS485.” If using a 24 port TZ Praetorian™ Junction, connect each cable to their respective “TZ RS485 A” and “TZ RS485 B” ports.

**Step 2:** Connect additional straight cables from each TZ SMARt™ locking devices RJ45 Coupler back to the numbered

ports on the front of the TZ Praetorian™ Junction. These cables can make use of the structured cabling already present in the data center; however, these runs should be limited to 100 meters.

**Step 3:** Connect the included power cord to test the system.

Power for the TZ Praetorian™ Trigger and TZ SMARt™ locking devices is supplied by the TZ Praetorian™ Junction over the same RJ45 cable that is used for communication. No additional power connection is required for these devices.

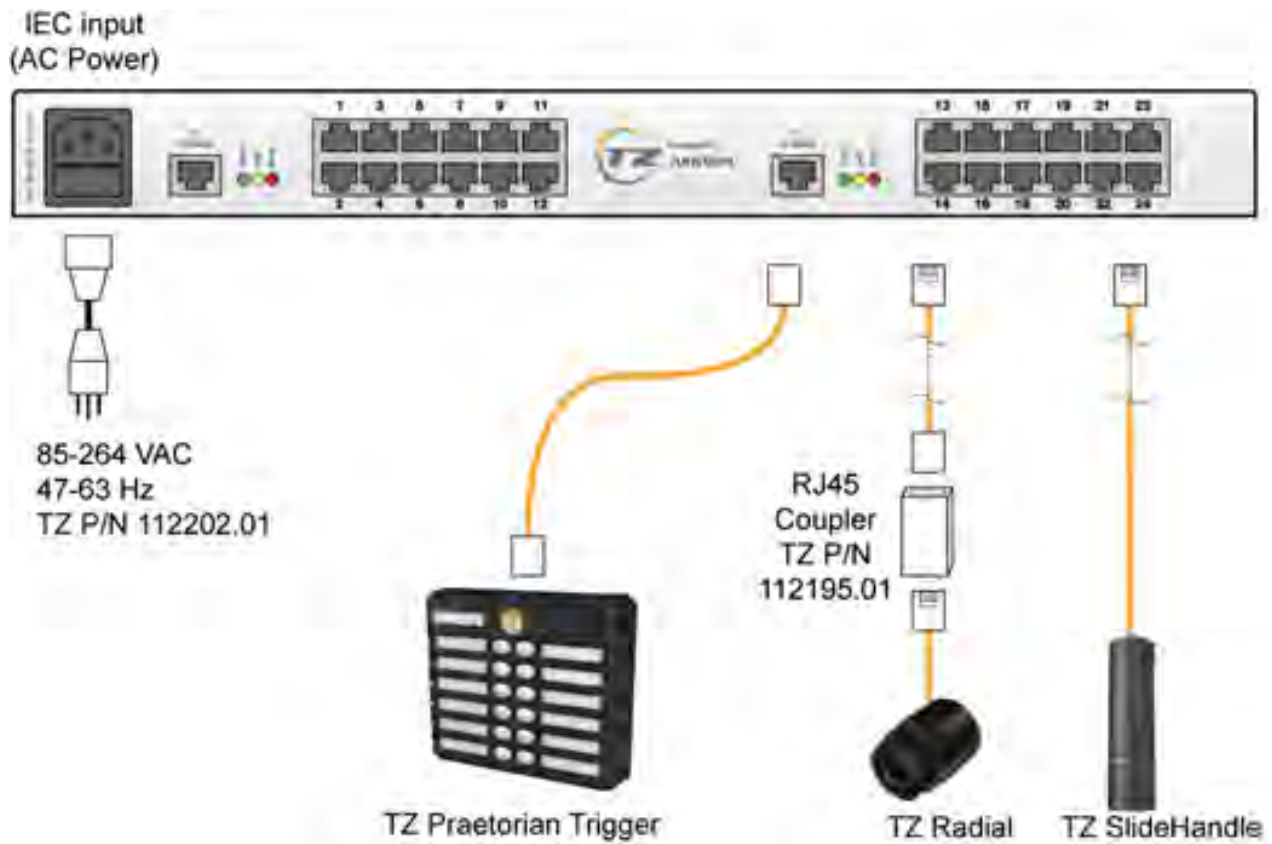

Figure 9: Wiring Diagram for TZ Praetorian™ Junction front panel.



### 6.3. Control System Provisioning

The control system needs to be configured to communicate with the TZ Praetorian™ Junction via relay (dry contact) outputs and inputs. Typically, this is done by provisioning the control system for “elevator control”. For details, consult your control system manual.

The control system needs to be configured to communicate with the TZ Praetorian™ Junction via relay (dry contact) outputs and inputs. Typically, this is done by provisioning the control system for “elevator control”. For details, consult your control system manual.

### 6.4. Install Validation Procedures

The test procedures outlined in Table 5 through Table 8 will aid in testing the installation of the TZ Praetorian™ System. If testing a 24-port system, be sure to verify operation on both the “A” and “B” sides.

Item	Pass/Fail	Comments
1. With the system installed and cabled per installation instructions, connect the power to the TZ Praetorian™ Junction. Observe the power up test sequence. Verify all LEDs illuminate during the test.		
2. Once booting has completed, verify the green status LED blinks at approximately 1/2 second intervals.		
3. Disconnect the TZ Praetorian™ Trigger from the TZ Praetorian™ Junction and verify the red error LED comes on solid. Plug the TZ Praetorian™ Trigger back in and verify the red error LED goes off.		
4. Verify the amber communication LEDs cycle through each of the TZ lock ports, 1 thru 12 (and 13 thru 24 if testing a 24 port system).		



TZ Locking Device Installation Tests

Item	Pass/Fail	Comments
<p>1. For each lock port where a TZ SMARt™ locking device is connected, verify the green connection LED is illuminated.</p>		
<p>2. To verify the correct TZ lock is connected to the correct port on the TZ Praetorian™ Junction, go to each cabinet one by one, disconnecting the cable from the lock at the RJ45 feed thru, and verify the green LED on the corresponding port of the TZ Praetorian™ Junction turns off. Be sure all cables are reconnected when complete.</p>		
<p>3. Disconnect the TZ Praetorian™ Trigger from the TZ Praetorian™ Junction and verify the red error LED comes on solid. Plug the TZ Praetorian™ Trigger back in and verify the red error LED goes off.</p>		
<p>4. With TZ locking devices connected, but unlocked, verify the TZ Praetorian™ Trigger is showing green “unlocked” status on each button that has a corresponding device. TZ SlideHandle™ LEDs should match the TZ Praetorian™ Trigger display.</p>		
<p>5. To verify the operation of the door sensor, go to each cabinet, one by one, and with the door open, push down and lock the TZ SlideHandle™. Verify the corresponding LED on the TZ Praetorian™ Trigger will show flashing red. This indicates the door sensor is working, telling the user that evethough the device is locked, the door is still open. Use the TZ Praetorian™ Trigger or key to unlatch the TZ SlideHandle™.</p> <p>If testing a TZ Radial™, insert a free stud, without magnet, into the TZ Radial™ so that it locks but doesn't activate the door sensor and verify TZ Praetorian™ Trigger button is still green. Activate the manual bypass to release the stud, then put the manual bypass back to the “operate” position.</p>		
<p>6. Close the door of the cabinet so that the door sensor is closed by the magnet. Push down on the TZ SlideHandle™ if necessary. With the cabinet secure, verify the corresponding button on the TZ Praetorian™ Trigger indicates secure by turning to red.</p>		



### TZ Locking Device Installation Tests

Item	Pass/Fail	Comments
7. To verify the operation of the doors, go through each port on the back of the TZ Praetorian™ Junction, temporarily remove the Wago connection going to the control system, and inserting the Wago connector with a jumper between pins 1 and 2. If the cabinet is locked and secured, then the corresponding button on the TZ Praetorian™ Trigger should change from red to blinking orange.		
8. On the Wago connector, verify the resistance between pins 3 and 4 is approximately 1000 ohms.		
9. Press the blinking button and verify the cabinet door is released, and the button changes to green.		
10. On the Wago connector, verify the resistance changes to 2000 ohms.		
11. Close the door and verify the button on the TZ Praetorian™ Trigger turns back to blinking orange.		
12. Repeat several times to verify the smooth operation of the door. When complete, close the cabinet door, remove the Wago connector with the jumper and replace the connection going to the control system. The corresponding button the TZ Praetorian™ Trigger should indicate cabinet secure by changing to red.		

Table 6: Locking Device Installation Tests



Key Bypass Tests

Table with 3 columns: Item, Pass/Fail, Comments. Contains 4 test steps for key bypass tests.

Table 7: Key Bypass Tests.

Control System Operational Test

Table with 3 columns: Item, Pass/Fail, Comments. Contains 8 test steps for control system operational test.

Table 8: Control System Operational Test.



## 6.5. TZ Praetorian™ Trigger Mounting

The TZ Praetorian™ Trigger can be mounted onto a cabinet, wall, or electrical junction box in a location convenient for using and viewing the status of enclosures in the system, such as at the end of a row of racks or near the entrance of a room. The card reader for the system should be in close proximity to the TZ Praetorian™ Trigger. The contents of the box include:

- > 1 x TZ Praetorian™ Trigger main housing assembly
- > 1 x TZ Praetorian™ Trigger rear plate
- > 4 x TZ Praetorian™ Trigger adhesive mount

Labels and clear plastic windows are not included. Each TZ Praetorian™ Trigger will require 13 labels and clear plastic windows (one for TZ Praetorian™ Trigger name/location and 12 for button/indicators). They can be ordered separately in a kit of 50 from Panduit #CSGLLC-L.

When preparing to mount the TZ Praetorian™ Trigger, care should be given to how the RJ45 cable from the TZ Praetorian™ Junction will be routed in to the enclosure.

There are three options for routing the interconnect cable from the TZ Praetorian™ Trigger to the TZ Praetorian™ Junction:

- > Hole in rear plate that exits through a hole or opening in mounting surface
- > Breakout opening in top of housing, capable of fitting 21 mm (0.83 in) outside diameter conduit
- > Breakout opening in bottom of housing, capable of fitting 21 mm (0.83 in) outside diameter conduit

The mounting of the TZ Praetorian™ Trigger is accomplished by first mounting the rear plate and then tabbing and snapping the TZ Praetorian™ Trigger main housing assembly into place. The rear plate can accommodate several different mounting scenarios including single gang box, dual gang box, drywall screws or adhesive mounting squares (included with system). Do not use the adhesive squares for mounting if the TZ Praetorian™ Trigger will be exposed to temperatures in excess of 50°C.

(See Table 9 for installation information)

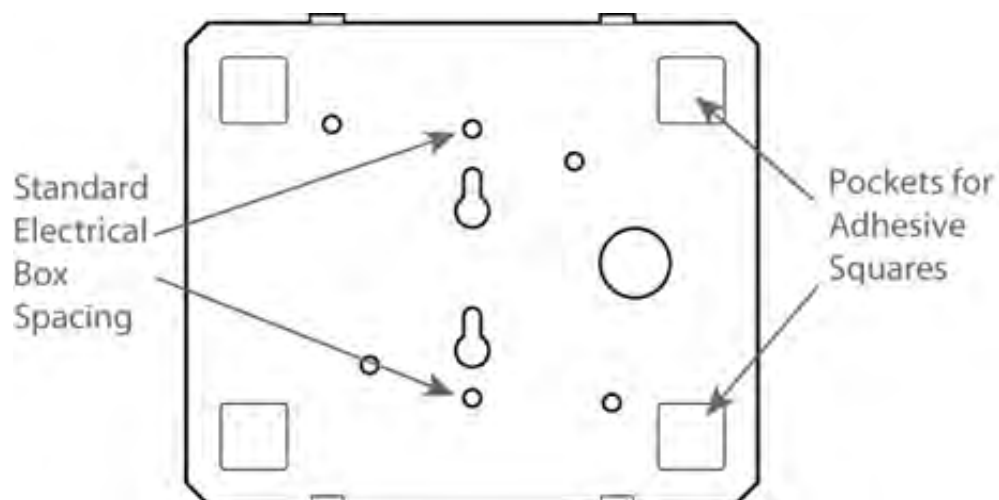

Figure 10: Rear Plate mounting location options, as viewed from the backplate.



## 6.6. TZ Praetorian™ Trigger Mounting Installation

### Installation Step

1. Align the mounting plate in the desired location and mark hole locations (if necessary.) Drill holes for the RJ45 connector and screw mounting (if necessary.)

Note: When drilling holes, ensure that necessary precautions are taken to prevent metal shavings from entering electronic equipment.

### Installation Illustration

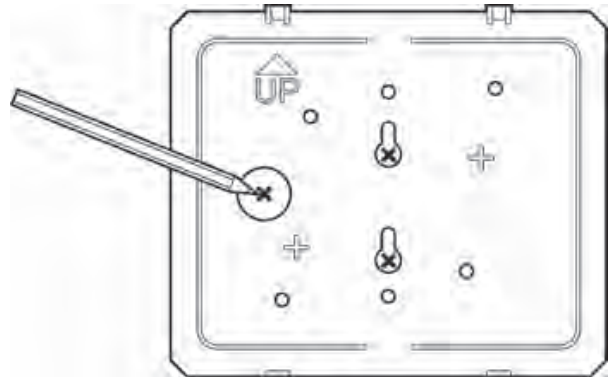

2. Fix the mounting plate using screws or supplied adhesive squares. Ensure that the plate is oriented correctly with the "Up" text and arrow pointing upward.

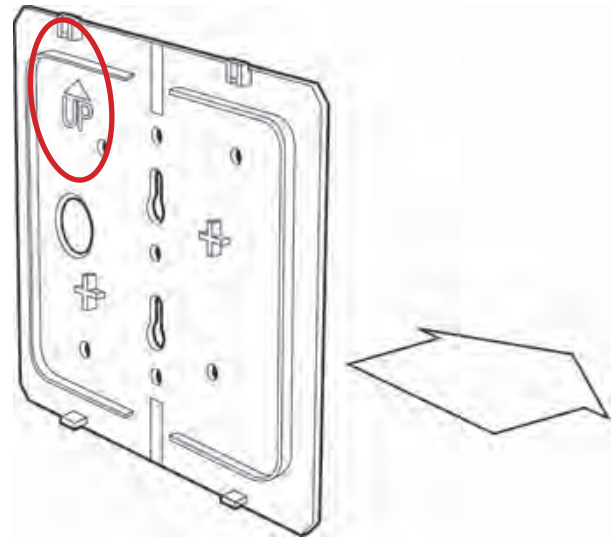





## 6.6. TZ Praetorian™ Trigger Mounting Installation

### Installation Step

3. Route the RJ45 cable through the RJ45 opening in the mounting plate and plug it into the appropriate connector on the TZ Praetorian™ Trigger PCB.

### Installation Illustration

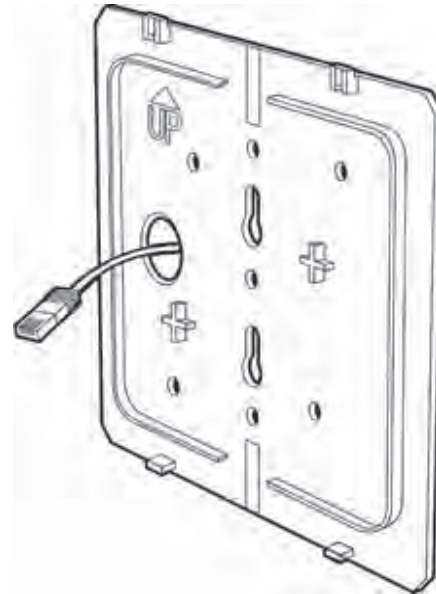

4. Align the top tabs on the mounting plate into the top square holes on the main housing. Swing the bottom end forward until the two housing snap together.

Follow the cable installation instructions below and connect to power to test for proper functionality.

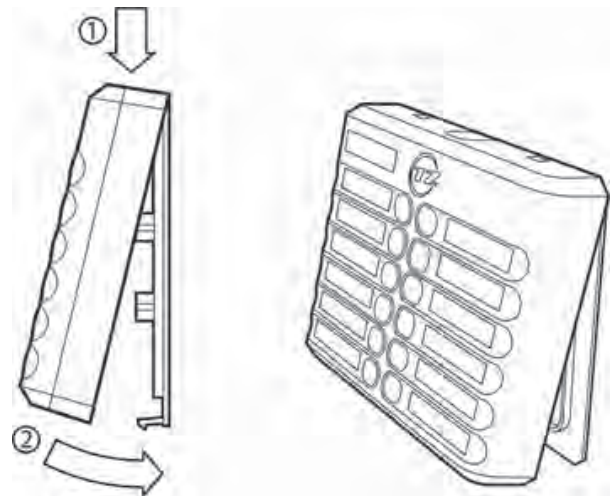

When installed correctly, the TZ Praetorian™ Trigger should fit securely in place. To remove or service the TZ Praetorian™ Trigger, simply reverse Step 4 above by using a flat-head screwdriver to depress the snaps and swing the main housing assembly away from the rear plate.



## 7.0. Troubleshooting Guide

If there are issues with the performance of the TZ Praetorian™ system the following table outlines the most common problems and their solutions.

Issue	Troubleshooting Recommendation
No lights on Junction.	Check cable connection, power and fuse.
No lights on Trigger.	Check cable connection.  Check that the TZ SMARt™ locking device or TZ SlideHandle™ is plugged in, and that there is no red error light on the junction.  Check that TZ Praetorian™ Trigger plugged into correct side of TZ Praetorian™ Junction.  Check junction cable, red error light on junction.
TZ Praetorian™ Trigger lights flashing green.	TZ Praetorian™ Trigger is plugged into a TZ SMARt™ locking device port
TZ Praetorian™ Trigger flashing red.	Check and replace connection cable.
Door closed, but trigger light not red.	Make sure door is closed and locked.  Check visually that sensor is aligned with magnet.  Check presence and position of door sensor in bracket.  Check the TZ SMARt™ locking device is not in Bypass mode.  Key has been used to unlock door, not fully seated back in place.  Ensure magnet has not been pressed back into housing (should be 2.4mm from top of housing).
Door doesn't latch.	Push door closed if door has been released with a key.  Check that TZ SMARt™ locking device is not in Bypass mode.  Check alignment to make sure stud is in place.  Ensure correct amount of spacers when mounting to get full engagement.
TZ Praetorian™ Trigger box doesn't close completely.	Check cable to avoid pinching.  Make sure mounting plate is right side up.
TZ SMARt™ locking device is not aligning or latching correctly.	Check that correct bracket being used.  Check and adjust alignment.



Issue	Troubleshooting Recommendation
Control not working properly.	Check screw terminal connections between control and TZ Praetorian™ Junction.
System not responding to card.	Check control, allow time if rebooting. Cable between control and TZ Praetorian™ Junction.
Door doesn't relock after key release.	Make sure key is back in neutral location. Make sure mount screws are not over-tightened.
Door open but TZ Praetorian™ light showing red.	Confirm that the TZ Radial™ or TZ SlideHandle™ is connected to the proper port on the TZ Praetorian™ Junction.
TZ Praetorian™ Trigger button doesn't blink orange.	Wiring between control and TZ Praetorian™ Junction not correct. Control not setup correctly. Door already open, indicating green.
Up to 2s delay in lock release.	Normal operation.
Only some lights out on TZ Praetorian™ Trigger.	TZ Radial™ devices disconnected from TZ Praetorian™ Junction. Swap patch cord cable.
Door doesn't unlatch after pressing orange light.	Check alignment of stud latch. Check that there is power to the system. Use key to unlock door, (twist key 1/8th of a turn max ) check cables.
Door doesn't unlatch after pressing orange light.	Check alignment of stud latch. Check that there is power to the system. Use key to unlock door, (twist key 45 degrees max) check cables.
TZ Radial™ stud catches when door opens.	Adjust radial positioning by loosening mounting screws and re-aligning, then re-tighten screws.
Door closed, but TZ Praetorian™ Trigger light not red.	Ensure magnet has not been pressed back into housing (should be 2.4mm from top of housing).

Table 10: Common problems with the TZ Praetorian and their solutions.



## Appendix 1: TZ Praetorian™ Junction Specifications

### TZ Praetorian™ Junction

The TZ Praetorian™ Junction interprets relay output from enterprise access control systems and responds with the status of other system components. The TZ Praetorian™ Junction provides data communication and power to one or two TZ Praetorian™ Triggers and either 12 or 24 RJ45 ports that connects to TZ locking devices through structured cabling.

The TZ Praetorian™ Junction interprets relay output from enterprise access control systems and responds with the status of other system components.

The TZ Praetorian™ Junction interprets relay output from enterprise access control systems and responds with the status of other system components. The TZ Praetorian™ Junction provides data communication and power to one or two TZ Praetorian™ Triggers and either 12 or 24 RJ45 ports that connects to TZ locking devices through structured cabling.

The TZ Praetorian™ Junction also provides pluggable screw terminal blocks for either 12 or 24 connections to the I/O cards of access control systems. It can also be mounted in a 19" 1U rack space, wall, shelf, or anywhere else convenient to the access controller and a structured cable patch panel.



### Features

- > Compatible with structured cabling standards for 100m length.
- > Screw terminal connections for 12 or 24 relay I/O from access controller.
- > RJ45 connections for power and data to 12 or 24 TZ locking devices.
- > RJ45 connections for power and data to 1 or 2 TZ Praetorian™ Triggers.
- > Wide range of input voltage: 90 to 250 VAC, 50 to 60Hz.
- > Versions available for 12- or 24-door capacity.

### Benefits

- > Industry standard cabling facilitates installation into existing infrastructure.
- > Compatible with 3rd party access control systems which enables retrofitting TZ locking devices such as TZ SlideHandle™ to existing security systems.
- > TZ locking devices do not require additional in-cabinet power reducing cost and installation time.
- > Capable of controlling multiple locks with one interface device over very long distances.
- > Universal power compatibility facilitates installation.
- > Scalable system to accommodate any size installation.
- > Serves multiple cabinets – up to 12 x two door cabinets and saves valuable in-cabinet rack space compared to other systems.
- > Flexible mounting options for rack, wall or shelf to facilitate installation.



## Specifications Overview

Specifications subject to change to suit particular application requirements.

## Physical Characteristics

Dims: 434.4mm x 209.2mm x 43.7mm (17.1" x 8.2" x 1.72")

Weight: 1.81 kg (4.0 lbs) or 2.5 kg (5.5 lbs)

Mounting: Standard 19" rack mountable spacing or can be wall mounted using the same brackets

CAUTION: This product should not be installed in a way that compromises the Ingress Protection (IP) rating of the enclosure in which it is mounted. Do not drill or otherwise produce metal shavings around electronic equipment.

## Environmental and Performance

Operating ambient temperature: 0°C to +50°C (32°F to 122°F)

Storage temperature: -15°C to +70°C (5°F to 158°F)

Humidity (operating): 20 to 80% RH, non-condensing

Ingress protection: IP 20

Estimated MTBF: 131,400 hrs @ 25°C

## Electrical

Voltage input: 100 to 240VAC, 1A, 50 to 60Hz, IEC C14 (1A, 250VAC, 5x20mm slow blow fuse included).

IEC C13 to NEMA 5-15 input cord included

RS-485 multi-drop communications interface via RJ-45

12 (model 7140AF) or 24 (model 7141AF) x RJ-45 connection to TZ locking devices

1 (model 7140AF) or 2 (model 7141AF) x RJ-45 connection to TZ Praetorian Trigger devices

12 (model 7140AF) or 24 (model 7141AF) x analog screw terminal I/O from controller: 2 input / 2 output

CAUTION: RJ-45 ports are not Ethernet compatible.

TZ Praetorian™ Junction has no user-serviceable parts and should only be opened by qualified service personnel.

## Dimensions (mm) (7141AF Model shown)

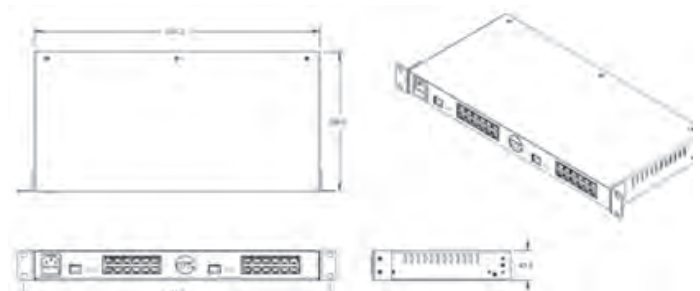



## Appendix 2: TZ Praetorian™ Trigger Specifications

### TZ Praetorian™ Trigger

The TZ Praetorian™ Trigger is an indicator and interface device that visually communicates the status of up to 12 doors and allows authorized users to open doors with the push of a single button. Colored LEDs behind each button indicates the locking state of the cabinet or enclosure doors:

- RED** All enclosure doors are closed and secure. Flashing indicates doors have been left open when locked or opened using unauthorized method.
- ORANGE** Flashing indicates access is currently authorized and a button push will open the enclosure. This is the only state in which a button push will have any effect.
- GREEN** The door is open or is otherwise not secure.



Each button can be labeled to correspond to the enclosure door that it is linked to and can trigger. The TZ Praetorian™ Trigger receives power and data communications from the TZ Praetorian™ Junction over standard patch cabling connections.

The device can be mounted onto a cabinet, wall, or electrical junction box in a location convenient for use and for viewing the status of all enclosures in the system. TZ recommends that it is placed at the end of a row of cabinets or near the entrance of a room in close proximity to the card reader.

### Features

- > Compatible with structured cabling standards for 100m length.
- > Colored LEDs indicate status on all connected doors.
- > Triggers up to 12 doors.
- > Flexible mounting options.
- > Standard labeling identifies cabinet.

### Benefits

- > Industry standard cabling facilitates installation into existing infrastructure.
- > Strong visual display easily identifies status and access to cabinet doors.
- > Capable of controlling multiple locks with one interface device for an economical installation.
- > Does not require additional power connection simplifying installation.
- > Suitable for mounting within data center cabinets or for wall mounting.
- > Complies with industry standard labeling.



---

## Specifications Overview

Specifications subject to change to suit particular application requirements.

---

### Physical Characteristics

Dims: 175 x 148 x 33mm (6.9" x 5.9" x 1.3")

Weight: 250 g (0.55 lbs)

Mounting via screws into any surface, standard electrical box hole spacing, or provided adhesive squares.

Label inserts: 13 x Panduit standard labels and clear plastic window inserts.

Conduit compatibility size: 21mm (0.83") outer diameter.

CAUTION: This product should not be installed in a way that compromises the Ingress Protection (IP) rating of the enclosure in which it is mounted. Do not drill or otherwise produce metal shavings around electronic equipment.

---

### Environmental and Performance

Operating ambient temperature: 0°C to +50°C (32°F to 122°F)

Storage temperature: -15°C to +70°C (5°F to 158°F)

Humidity (operating): 20-80% RH, non-condensing

Non-combustible materials

Ingress protection: IP 30

Keypad cycles: >500k

Do not use adhesive squares for mounting if the Trigger will be exposed to temperatures in excess of 50°C

Estimated MTBF: 262,800 hrs @ 25°C

---

### Electrical

Low voltage supplied via RJ-45 input from straight through connection to TZ Junction

CAUTION: RJ-45 ports are not Ethernet compatible

---

### LED Indicators

Red – door closed.

Flashing Red - door unsecure of unauthorized access.

Flashing Orange – door authorized.

Green – door open.

No Light – No connection or error.

---



infrastructure  
protection

protection  
infrastructure

TZ Praetorian™ System

Model Numbers: 7140AF/7141AF and 8108AF

---

### Standards Compliance

FCC Part 15, CE, UL (c-us) per IEC/UL/CSA 60950-1

RoHS compliant, One Year Limited Warranty

---

### Dimensions (mm)

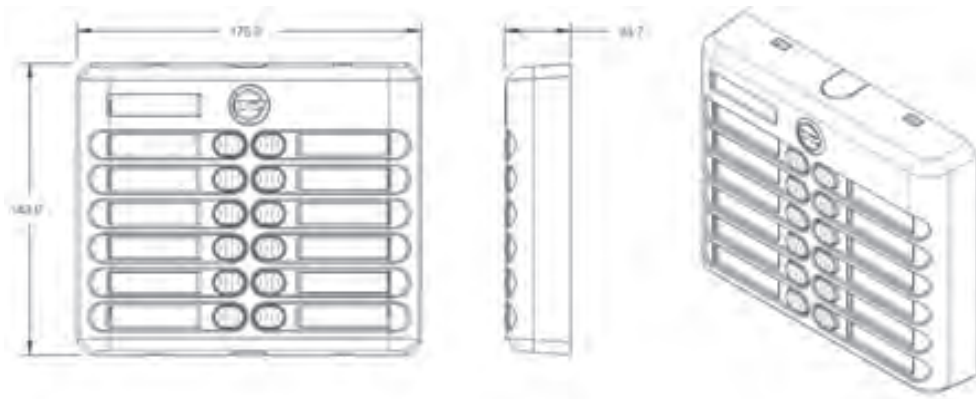





infrastructure  
protection

protection  
infrastructure

[ixp.tz.net](http://ixp.tz.net)