

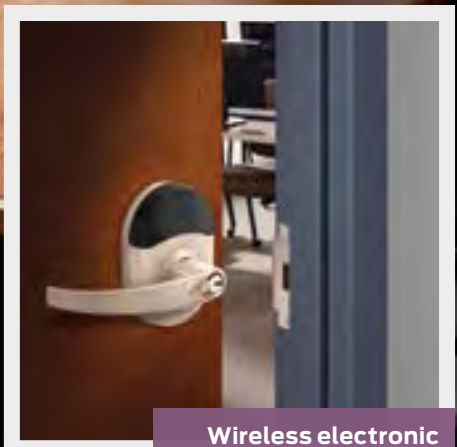

# ND Series

Grade 1 cylindrical locks

Mechanical  
Wired electrified  
Wireless electronic

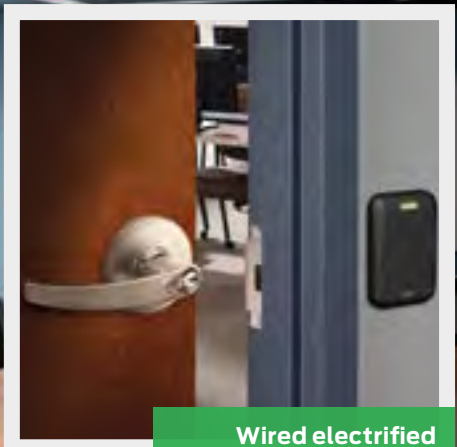

# The Schlage® ND Series cylindrical locks

Walter Schlage invented the cylindrical lock in 1920. Since then, Schlage Lock Company has consistently delivered innovation and continuous improvement. In that tradition, we are extremely proud to introduce the redesigned ND Series cylindrical lock.

Most manufacturers' approach to locks ends with simply meeting industry standards like Grade 1. With the Schlage ND, Grade 1 is just the beginning.

## Performance beyond Grade 1

The Schlage ND family significantly exceeds BHMA Grade 1 requirements for cycle, lever torque, hammer blow, lever pull and other tests. This means confidence that the lock will last—whether the application calls for high abuse resistance or just operation over millions of cycles—without any degradation in performance.

## Comprehensive offering for every opening

Mechanical, wired electrified and wireless electronic solutions allow a common aesthetic and consistent user experience throughout the building while lowering the total cost of ownership.

## World-class design

A proven, easy to install product with extensive function, keying, trim and finish capabilities that work in nearly any applications.



## Cylindrical lock comparison

ND  
mechanical**Applications**

The Schlage ND is extremely versatile and is regularly used in healthcare, education, government, office, retail and other commercial applications.

With 31 mechanical functions, the ND's range spans from the simple (non-locking passage) to complex (double-cylinder security) to specialized (school time-out lock).

Because the ND uses an ANSI 161 door prep, commonly used across cylindrical locks, it is ideal for both new construction and retrofit applications.

**Key features**

- Significantly exceeds ANSI/BHMA A156.2 requirements for Grade 1 cylindrical locks
- 31 mechanical functions (see adjacent columns for wired electrified and electronic options)
- Five lever designs, two rose designs
- 10 available finishes
- Supports standard, SFIC and FSIC cylinder formats
- Multiple key systems available – open, patented, restricted, geographic exclusive, UL437
- Support for 10 non-Schlage cores (see cylinder section)

ND wired  
electrified**Applications**

Wired electrified locks complement the mechanical offering and are typically incorporated into a wired access control system or used independently with a remote access switch (e.g. switch behind a receptionist desk).

The electrified ND is ideally used in:

- high traffic areas, where line power ensures continuous operation
- new construction, where electrified door prep, hinges and wiring can easily be incorporated into the building

**Key features**

All mechanical features plus:

- auto-detecting 12-24VDC input
- selectable EL/EU operation
- low 0.23 amp max current draw that allows multiple locks on a single power supply
- low 0.010 amp holding current that eliminates “hot levers” in electrically locked applications
- modular Request to Exit (RX) that can be added at any time
- inventory friendly—one lock supports 12-24V, EL or EU, with or without RX
- six electrified functions for application flexibility

NDE wireless  
electronic**Applications**

Wireless electronic locks complete the offering by delivering all of the access control system hardware components required at the door in a single integrated design.

NDE wireless lock applications include:

- retrofit applications where electronic credentials can be used for improved visibility and control
- new construction to expand the scope of access control to interior openings
- low to medium traffic areas, where battery power delivers long life

**Key features**

All mechanical features<sup>1</sup> plus:

- Fits standard ANSI 161L mechanical door prep
- Installs in minutes with only a Phillips screwdriver
- Integrated card reader, door position sensor and Request to Exit (RX) switch
- Built-in Bluetooth® enables wireless configuration from smart phones and tablets
- Built-in Wi-Fi enables automatic updates to access rights
- Capable of networked real-time communication<sup>2</sup>
- Up to 2 years of battery life (4 AA)

<sup>1</sup> NDE wireless electronic lock available in 3 lever designs, 1 rose design, and 9 finishes only

<sup>2</sup> Requires ENGAGE™ Gateway and alliance access control software

From mechanical to wired electrified to wireless electronic the ND Series offers a grade 1 solution for the entire project.

 **ND mechanical**



Suitable for all openings

 **ND wired electrified**



Ideal for high-traffic access control

 **NDE wireless electronic**



Ideal for low-traffic access control

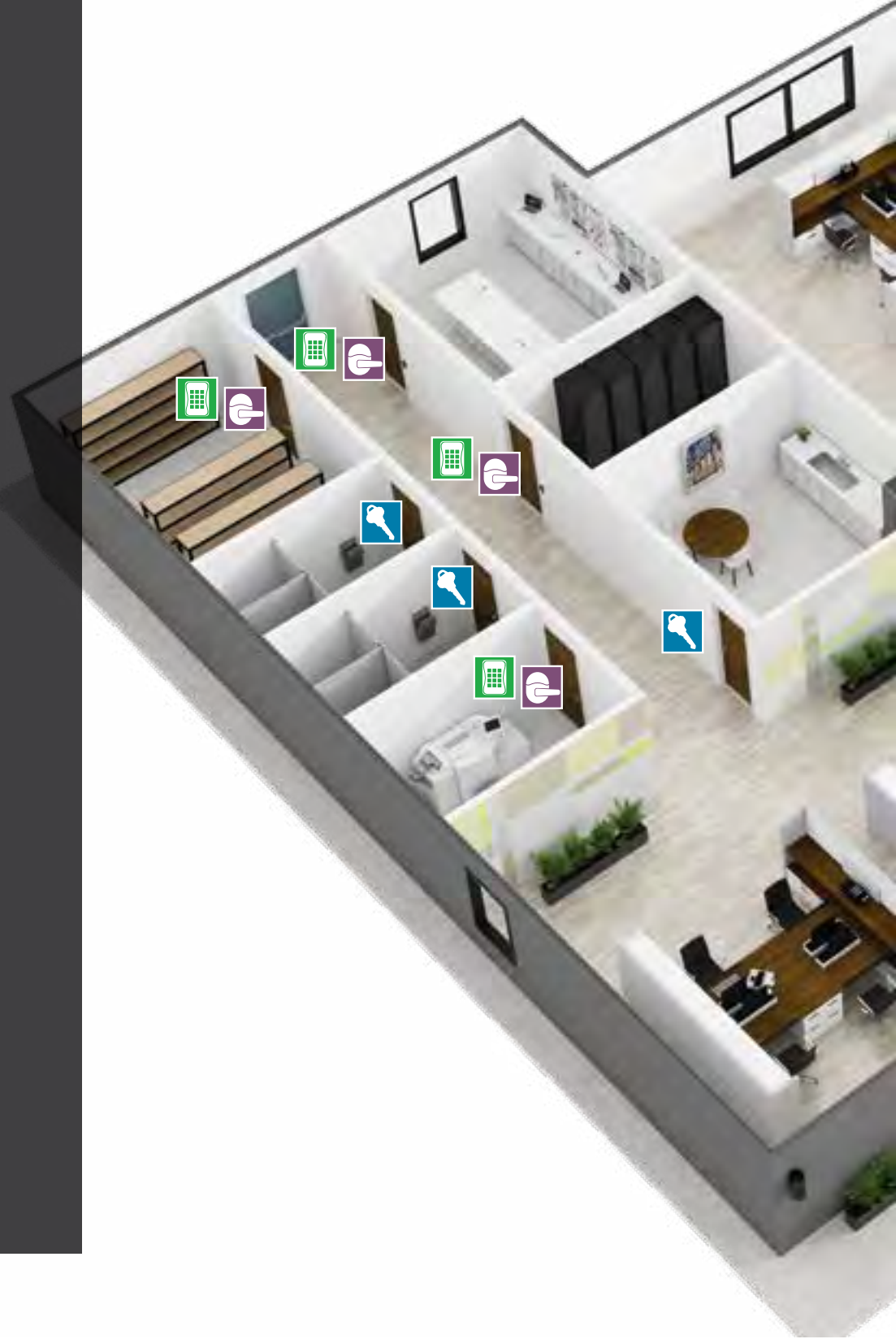



Selection guide

Key features

Trims and finishes

Mechanical

Wired electrified

Wireless electronic

Keys and credentials

Parts

Specifications

## STRONG

The ND Series has been redesigned to make it the strongest cylindrical lock Schlage has ever built.

- No access with minimum 3,100 in-lb abusive lever torque — the equivalent of over 690 lbs applied to the end of a 4 1/2" lever (2.6x BHMA requirements<sup>1</sup>)
- No access with minimum 1,600 lbs offset lever pull for protection against pry bar attacks (8x BHMA requirements<sup>1</sup>)
- No access with minimum 100 vertical impacts<sup>1,2</sup> for protection against sledgehammer attacks (20x BHMA requirements<sup>1</sup>)
- Near zero droop and wobble after 16M cycles (16x BHMA requirements<sup>1</sup>), without the use of set screws or O-rings
- Latch retraction with 200lb preload for confident operation in warped and preloaded doors (4x BHMA requirements)

<sup>1</sup> Beyond grade 1 performance for ND locks with Schlage cylinders only (standard, FSIC & SFIC). Performance with non-Schlage cylinders will exceed BHMA grade 1 requirements but may be less than the performance of products with Schlage cylinders.

<sup>2</sup> Vertical impact testing stopped after 100 blows with no sign of failure or stress.

## SECURE

A strong lock is only part of the security equation—proper key and card access control is equally important.

- Standard Everest 29™ key system prohibits unauthorized duplication at local stores and is patent protected until 2029
- Available restricted and geographic exclusive keyways for advanced key control
- Available compatibility with 10 different non-Schlage key systems
- New SL cylinder allows SFIC keyways in standard cylinders, providing multiple new keying solutions including geographically exclusive SFIC
- Wired electrified and wireless electronic locks enable the use of electronic credentials for increased visibility and control over access
- aptiQ® smart cards with MiFare® DESFire® EV1 technology utilize encryption, mutual authentication and key diversification to ensure the highest levels of security



## SMART

Smart means using innovation to make your project more efficient, flexible, and easier to install and use.

- One platform, three solutions (mechanical, wired electrified, wireless electronic)—same look and feel throughout the building for a common user experience and lower cost of ownership
- Wired electrified lock has autodetecting 12/24V input, selectable EL/EU operation, and plug-in Request to Exit (RX) for installation and inventory flexibility. Energy efficient design allows multiple locks on a single power supply with no "hot levers"
- Wireless electronic locks with ENGAGE™ can be managed with an access control system or with convenient ENGAGE web and mobile applications.
- Wireless electronic locks provide the option to leverage existing network infrastructure for offline or real-time applications
- Can upgrade from ND mechanical lock to NDE wireless electronic with only a screwdriver



Schlage is more than locks. It's the complete infrastructure of support throughout the entire build and ownership process.

- Order entry, customer service, technical support, engineering and manufacturing co-located in the same building in Colorado Springs, Colorado
- Comprehensive support from our sales offices including consultations, masterkey development and training; industry and code training, specification writing, and product service
- Schlage products suite with other Allegion brands including Von Duprin® exit devices, LCN® door closers, and Steelcraft® doors and frames
- Custom engineering department can develop specialized functions, trim and finishes for unique applications
- Trusted partner for nearly 100 years

A detailed look...

ND mechanical

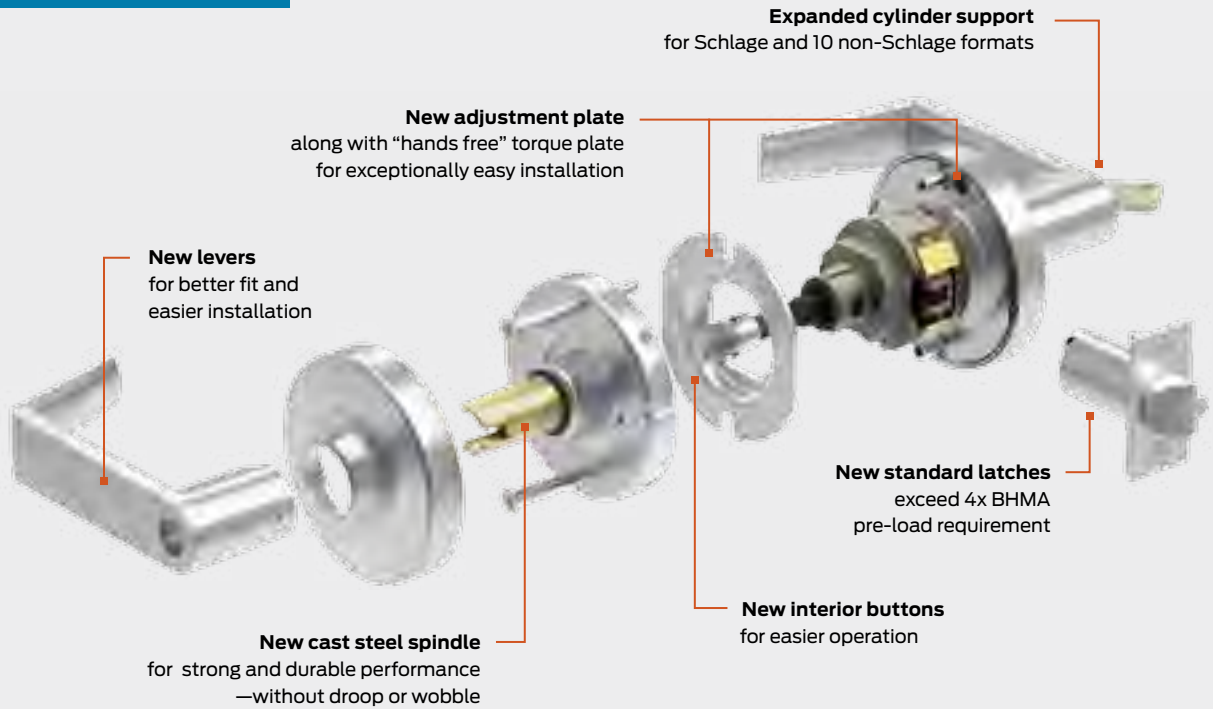

ND wired electrified

All mechanical features +

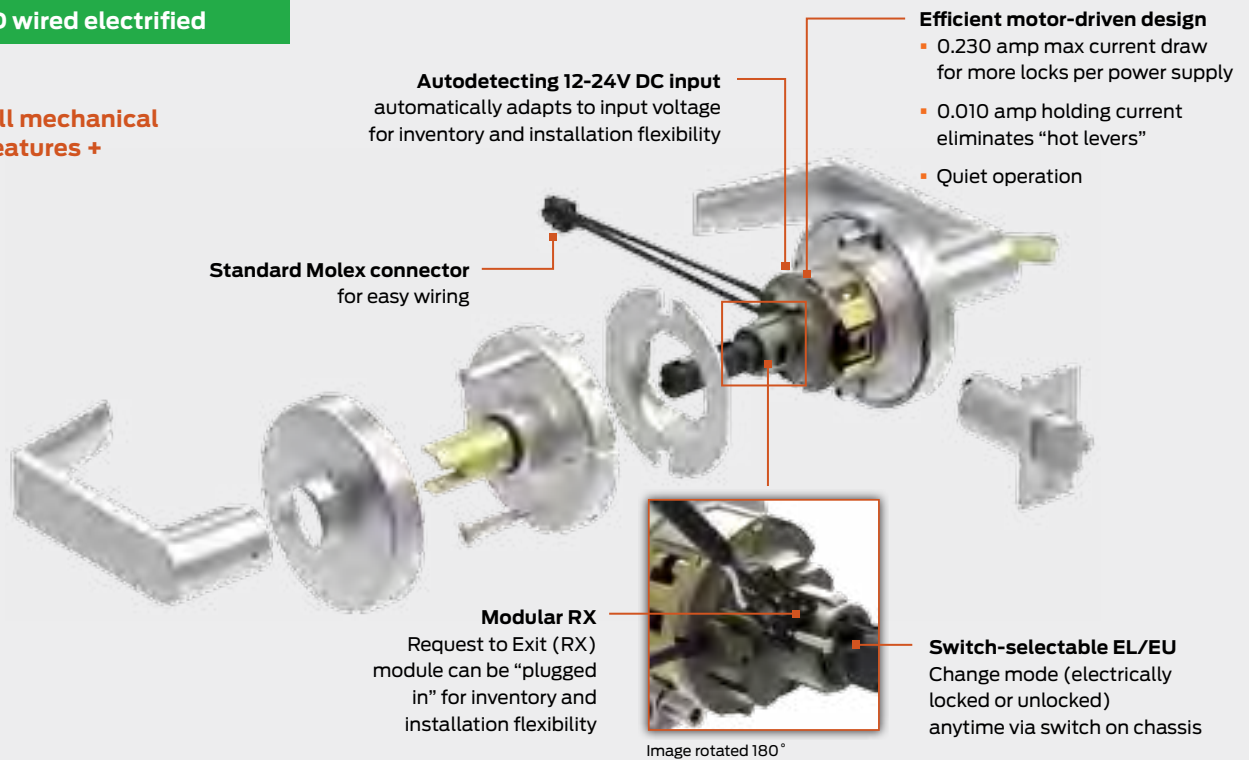



NDE wireless electronic

All mechanical features +



Designs and finishes

# Lever designs and finishes

Athens (ATH)<sup>2</sup>

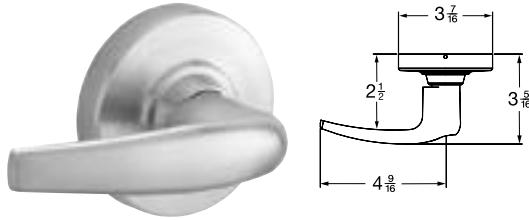

Mechanical | Wired electrified | Wireless electronic

Sparta (SPA)<sup>1,2</sup>

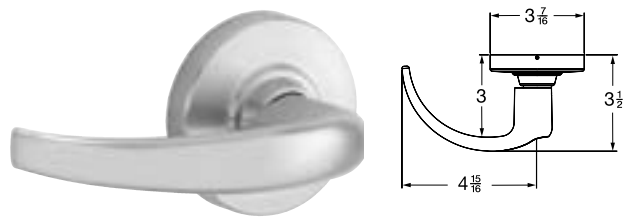

Mechanical | Wired electrified | Wireless electronic

Rhodes (RHO)<sup>1,2</sup>

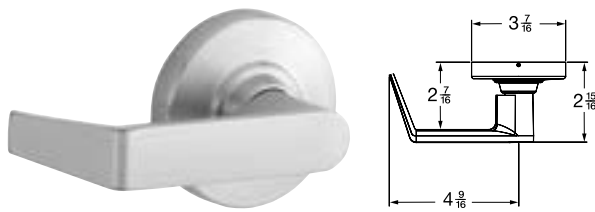

Mechanical | Wired electrified | NDE wireless electronic

Tubular (TLR)<sup>1,2</sup>

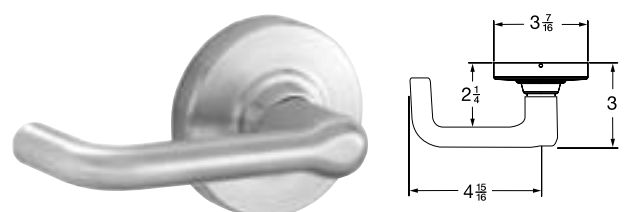

Mechanical | Wired electrified

Omega (OME)<sup>1</sup>

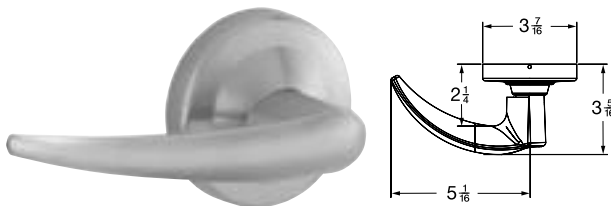

Mechanical | Wired electrified

All levers comply with the Americans with Disabilities Act (ADA).

- 1 Rhodes, Sparta, Tubular and Omega levers comply with California State code for return within 1/2" of door face.
- 2 All levers except Omega can support cylinders from other manufacturers, see cylinder section page 24 for details.

Finish options



Color	Bright brass	Satin brass	Satin bronze	Oil rubbed bronze	Satin nickel	Matte black	Bright chrome	Satin chrome	Aged bronze
ANSI/BHMA number	605	606	612	613	619	622	625	626/626AM	643e
US number	US3	US4	US10	US10B	US15	US19	US26	US26D	US11
Mechanical	■	■	■	■	■	■	■	■	■
Wired electrified	■	■	■	■	■	■	■	■	■
Wireless electronic	■	■	■	—	■	■	■	■	■

Product information and specifications contained in this catalog are subject to change without notice. Please consult the factory.

## Accessibility and life safety

# Accessibility and life safety

Door hardware should be as effective in helping people go about their lives as it is in securing their environments. The Schlage ND is designed with this requirement in mind.

### Accessibility

All Schlage ND levers comply with the Americans with Disabilities Act (ADA), which requires that “Operable parts shall be operable with one hand and shall not require tight grasping, pinching, or twisting of the wrist. The force required to activate operable parts shall be 5 pounds (22.2 N) maximum.”



### Tactile warning for the visually impaired

Tactile warning is a special texture applied to the outside lever to alert the visually impaired to a potential hazard on the opposite side of the door (exit to street, a workshop or other hazardous area, etc). Tactile warning is typically applied to the outside lever only, and is specified by an 8 prefix on the lever design.

Milled

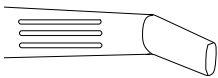

Order as follows:  
8AT for Athens  
8RO for Rhodes  
8SP for Sparta

Knurled

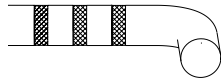

Order as follows:  
8TR for Tubular

### Life safety

The Schlage ND is UL listed for use on 3-hour fire doors up to 4'0" x 10'0". The Rhodes, Sparta, Tubular and Omega levers comply with the California State fire code for return to within 1/2" of the door face.

Additionally, the Schlage ND exceeds the BHMA warped door test by 4x. The BHMA standard requires that the latch be able to retract with a 50lb pre-load; the ND can retract the latch with a 200lb preload - providing more range to open the door in the event the opening becomes bound or otherwise compromised.

### Classroom security indicator rose

Schlage ND classroom security functions come standard with an indicator rose that clearly identify key rotation direction for rapid lockdown. For ND mechanical classroom security function only.



### Door handing

The ND lock family can be configured during installation to support any door handing. As a result, it is not necessary to specify handing during the ordering process.

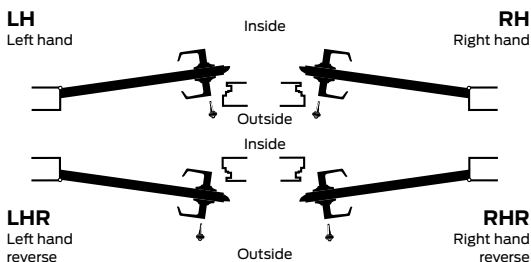

# ND Series mechanical lock

The ND mechanical lock, along with being Schlage's best selling mechanical lock, is the foundation for both the wired electrified and NDE wireless electronic lock. Not only did Schlage invent the cylindrical lock, but we continue to make it better and are pleased to announce the following updates for Spring 2017:

- Unparalleled strength - the lock prevents access even when subjected to torque loads up to 3,100 in-lbs (2.6x BHMA<sup>1</sup>), withstands pry bar attacks of 1,600 lbs (8x BHMA requirements<sup>1</sup>), and withstands 100 hammer blows (20x BHMA requirements<sup>1,2</sup>)
- Exceptional durability - cycle tested to over 16M cycles (16x BHMA requirements<sup>1</sup>) with near zero droop or wobble - without the use of set screws or O-rings
- Improved feel - improved strength and durability are more than numbers, you can actually feel it in the lock
- Improved installation - installation is even easier than before (and without any set screws or O-rings)

All this is in addition to what you know and expect with the Schlage ND: 31 mechanical functions (plus wired electrified and wireless electronic) to meet the needs of any application; five lever designs that suite with other Schlage locks and Von Duprin exit devices; simple installation and renowned sales, customer, and technical support.



1 Beyond grade 1 performance for ND locks with Schlage cylinders only (standard, FSIC & SFIC). Performance with non-Schlage cylinders will exceed BHMA grade 1 requirements but may be less than the performance of products with Schlage cylinders.

2 Vertical impact testing stopped after 100 blows with no sign of failure or stress.

**ND Series mechanical lock**  
**Keyed function list**

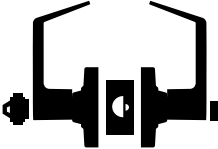
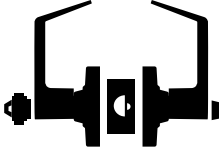
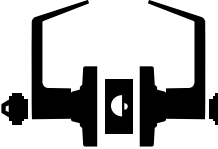
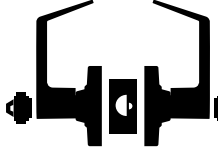
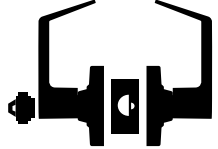
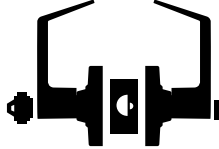
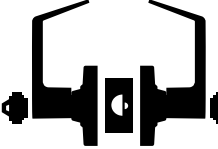
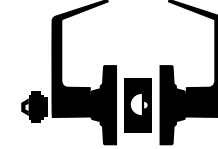
<p>Schlage                      ANSI</p> <p><b>ND50PD                      F82</b></p> <p><b>Entrance/office lock</b></p> <ul style="list-style-type: none"> <li>• Push-button locking.</li> <li>• Push-button locks outside lever until it is unlocked with key or by turning inside lever.</li> <li>• Inside lever always free for immediate egress.</li> </ul> <p>Outside                      Inside</p> 	<p>Schlage                      ANSI</p> <p><b>ND53PD                      F109</b></p> <p><b>Entrance lock</b></p> <ul style="list-style-type: none"> <li>• Turn/push-button locking: Pushing and turning the button locks the outside lever, requiring use of a key until the button is manually unlocked.</li> <li>• Push-button locking: Pushing button locks outside lever until unlocked by key or by turning the inside lever.</li> <li>• Inside lever always free for immediate egress.</li> </ul> <p>Outside                      Inside</p> 	<p>Schlage                      ANSI</p> <p><b>ND60PD                      F88</b></p> <p><b>Vestibule lock</b></p> <ul style="list-style-type: none"> <li>• Latch retracted by key from outside when outside lever is locked by key in inside lever.</li> <li>• Inside lever always free for immediate egress.</li> </ul> <p>Outside                      Inside</p> 	<p>Schlage                      ANSI</p> <p><b>ND66PD                      F91</b></p> <p><b>Store lock†</b></p> <ul style="list-style-type: none"> <li>• Key in either lever locks or unlocks both levers.</li> </ul> <p>Outside                      Inside</p> 
<p>Schlage                      ANSI</p> <p><b>ND70PD                      F84</b></p> <p><b>Classroom lock</b></p> <ul style="list-style-type: none"> <li>• Outside lever locked and unlocked by key.</li> <li>• Inside lever always free for immediate egress.</li> </ul> <p>Outside                      Inside</p> 	<p>Schlage                      ANSI</p> <p><b>ND73PD                      F90</b></p> <p><b>Corridor lock</b></p> <ul style="list-style-type: none"> <li>• Locked or unlocked by key from outside.</li> <li>• Push-button locking from inside.</li> <li>• Turn inside lever or close door to release button.</li> <li>• When outside lever is locked by key it can only be unlocked by key.</li> <li>• Inside lever always free for immediate egress.</li> </ul> <p>Outside                      Inside</p> 	<p>Schlage                      ANSI</p> <p><b>ND75PD                      -</b></p> <p><b>Classroom security lock</b></p> <ul style="list-style-type: none"> <li>• Key in either lever locks or unlocks outside lever.</li> <li>• Inside lever always free for immediate egress.</li> </ul> <p>Outside                      Inside</p> 	<p>Schlage                      ANSI</p> <p><b>ND80PD                      F86</b></p> <p><b>Storeroom lock</b></p> <ul style="list-style-type: none"> <li>• Outside lever is fixed.</li> <li>• Entrance by key only.</li> <li>• Inside lever always free for immediate egress.</li> </ul> <p>Outside                      Inside</p>  <p>Available with RX</p>

## Product specifications

		ND mechanical and ND wired electrified	NDE wireless electronic
Chassis	Material	Modular design of zinc and steel components plated for corrosion protection	
	Door thickness	Standard: 1 5/8" to 2 1/8" Optional: 1 3/8" - 6" EE, EO, EI, ED configurations	Standard - 1 5/8" to 2"
Trim	Handing	Non-Handed	Default to Right Hand, configurable without tools
	Levers	Standard: 5 designs, pressure cast zinc, plated to match product finish specification Optional: Tactile feature - Athens (ATH), Rhodes (RHO), Sparta (SPA), Tubular (TLR)	Standard: 3 designs, pressure cast zinc, plated to match product finish specification Optional: Tactile feature - Athens (ATH), Rhodes (RHO), Sparta (SPA)
	Roses	Wrought brass, bronze, or zinc, plated to match product finish specification	Zinc, plated to match product finish specification
	Finishes	10 available (605, 606, 612, 613, 619, 622, 625, 626, 626AM, 643e)	9 available (605, 606, 612, 619, 622, 625, 626, 626AM, 643e)
Latches	Backset	Standard: 2 3/4" Optional: 2 3/8", 3 3/4", 7 3/4"	Standard: 2 3/4" Optional: 2 3/8"
	Faceplate	Standard: 1 1/8" x 2 1/4" Optional: 1" x 2 1/4" for 2 3/8" backset doors	Standard: 1 1/8" x 2 1/4"
	Bolt	Standard: 1/2" throw via Oil Impregnated Stainless Steel Optional: 3/4" throw anti-friction bolt available for pairs of doors	
	Strike	Standard: ANSI Curved Lip: 1 1/4" x 4 7/8" x 1 3/16" Optional: T Strike, ANSI strikes with alternative lip lengths, dust box options	
Keying	Formats	Standard: 3 Schlage (KIL or FSIC or SFIC) Optional: 10 Non-Schlage including cylinders from Best, Corbin Russwin, Medeco, Sargent and Yale	
	Access security	Standard: 6-Pin Patented Everest 29 Optional: Open, Restricted, Primus, master keying, construction keying	
Wired electrified	Input voltage	Autodetecting 12-24V DC, + 10%	—
	Operating mode	Fail Safe or Fail Secure via switch on chassis	—
	Current draw	0.23 amps maximum; 0.01 amps holding	—
	Request to Exit	Modular - 3A @ 125VAC / 2A @ 30VDC	—
Wireless electronic	Input voltage	—	4 AA batteries
	Operating mode	—	Selectable - secured, as-is, or passage
	Communication	—	2.4 GHz Wi-Fi (IEEE 802.11b/g) Bluetooth low energy (version 4.0)
	Request to Exit	—	Integrated into chassis
	Door position sensor	—	Integrated magnetometer with strike and magnet assembly. Includes magnetic tamper alert.
	Tamper sensor	—	Integrated interior cover tamper
Warranty	Mechanical	10 years mechanical, 1 year wired electrified	1 year wireless electronic
Certifications	ANSI/BHMA	All ND Series comply with A156.2 performance requirements for grade 1 cylindrical locks. Wired electrified complies with A156.25 (indoor), wireless electronic complies with A156.25 (indoor/outdoor) requirements for electrified locking devices	
	ICC	Complies with ICC A117.1 Accessible and Usable Buildings and Facilities	
	UL/cUL	All locks 3 hour A label single fire door 4'0" x 10'0"; pair doors 3 hour fire door 8'0" x 8'0" with 3/4" latch option; pair doors 90 minute fire 8'0" x 10'0" with 3/4" latch option	
	CA Fire Code	All levers with a return to door of 1/2" (64 mm) or less comply (Rhodes, Sparta, Tubular and Omega)	
	FL Building Code	Complies with Florida Building Code (ASTM E330, E1886, E1996) and Miami Dade (TAS 201, 202, 203) requirements for hurricanes	
	Federal	Meets FF-H-106C Series 161	—
	Other	—	UL294, CSA C22.2 No. 205-M1983, FCC Part 15, IC RSS-210, RoHS

## Architectural architectural specifications

### General specifications - applies to mechanical, wired electrified & NDE wireless electronic

1. Provide Schlage ND Series cylindrical locks conforming to the following standards and requirements:
    - a. ANSI/BHMA A156.2 Series 4000, Grade 1
    - b. UL10C for 4'0" x 10'0" 3-hour fire door
    - c. Florida Building Code (ASTM E330, E1886, E1996) and Miami Dade (TAS 201, 202, 203) requirements for hurricanes
  2. Provide cylindrical locks **exceeding** the ANSI/BHMA A156.2 Grade 1 performance standards for strength, security and durability in the categories below:
    - a. **Abusive locked lever torque** – minimum 3,100 inch-pounds without gaining access
    - b. **Offset lever pull** – minimum 1,600 foot pounds without gaining access
    - c. **Vertical lever impact** – minimum 100 impacts without gaining access
    - d. **Cycle life** – minimum 16 million cycles
      - 1 With no visible lever sag
      - 2 Without the use of performance aids (i.e. – set screws, spacers, etc.)
  3. Provide locksets with **solid cast levers** and **wrought roses** on both sides. (**ND mechanical, ND wired electrified**)
    - a. Lever design: Rhodes; Athens, Sparta, Tubular or Omega
    - b. Rose design: Rhodes (used with Rhodes, Athens, Sparta, and Tubular levers) or Omega (used with Omega lever)
    - c. **OPTION (where required by Authority Having Jurisdiction)** - Provide tactile warning (knurling) on levers on exterior (secure side) of doors serving rooms or areas considered to be hazardous.
    - d. **OPTION** - Provide break away Rhodes levers for an additional level of security
  4. Provide locksets with **solid cast levers** and **cast escutcheons** on both sides (**NDE wireless electrified**)
    - a. Lever design: Rhodes; Athens or Sparta
    - b. **OPTION (where required by Authority Having Jurisdiction)** - Provide tactile warning (knurling) on levers on exterior (secure side) of doors serving rooms or areas considered to be hazardous.
    - c. **OPTION** - Provide break away Rhodes levers for an additional level of security
  5. Provide locksets with **solid steel anti-rotation** through bolts and posts to control excessive lever rotation
  6. Provide **independently operating levers** with two external return spring cassettes mounted under roses to prevent lever sag.
  7. **OPTION/Standard NDE wireless electrified** – Provide Vandlgard/Free-Wheeling levers with vandal resistant technology for use at heavy traffic or abusive applications.
  8. **OPTION** - Provide cylindrical locks with an inside indicator feature on a 626 finish for the Rhodes and Omega roses that provides clear direction for users to safely and quickly secure the room
    - a. **ND75 and ND95 – Standard**
    - b. **ND60 and ND93 – OPTION**
  9. Provide locks with **standard latches** featuring a 2 3/4" (70 mm) backset and a 1/2" latch throw capable of UL listing of 3 hours on a 4.0 x 10.0 opening. Provide proper latch throw for UL listing at pairs.
  10. Provide standard **ASA strikes** unless extended lip strikes are required to protect trim.
  11. **OPTION ND mechanical** – Provide reconfigurable lockset chassis that allows lock function to be changed to over twenty other common functions by swapping easily accessible parts
- Add for ND wired electrified**
12. Provide wired electrified options as scheduled in the hardware sets.
    - a. 12 through 24V DC operating capability, autodetecting
    - b. Selectable EL (Fail Safe)/EU (Fail Secure) operating mode via switch on chassis
    - c. 0.230A (230mA) maximum current draw
    - d. 0.010A (10mA) holding current
    - e. Modular / "plug in" Request to Exit switch
- Add for NDE wireless electronic**
12. Provide lockset with additional standard compliance:
    - a. Listed, UL 294 - standard of Safety for Access Control System Units
    - b. Compliant with ANSI/BHMA A156.25 Grade 1 Operation and Security
    - c. Certified to FCC Part 15
  13. Provide credential reader module in the following configuration, as indicated in the door hardware sets. Multi-technology contactless reader shall be NFC-Compatible, including NFC Peer to Peer compatibility, and read access control data from both 125 kHz and 13.56MHz contactless smart cards.
  14. Provide lockset with the following switches/monitors standard:
    - a. Door Position Sensor (DPS)
    - b. Interior cover tamper guard
    - c. Request to Exit (RX) switch
  15. Provide locksets with the following features
    - a. Ability to communicate unit's communication status
    - b. Visual tri-colored LED indicator that indicates activation, operational systems status, system error conditions and low power conditions
    - c. Audible feedback that can be enabled or disabled
    - d. Tamper resistant torx screw on inside escutcheon
  16. Provide lockset with open architecture characteristics capable of handling new and existing access control software and credential reading technology
  17. Provide lockset powered by four AA batteries
    - a. Provide locksets able to communicate battery status and battery voltage level by means of application on mobile device at the door or remotely via integrated software
- 1 Beyond grade 1 performance for ND locks with Schlage cylinders only (standard, FSIC & SFIC). Performance with non-Schlage cylinders will exceed BHMA grade 1 requirements but may be less than the performance of products with Schlage cylinders.