

# ML2000 Series

---

## Mortise Locksets



# Overview

## ML2000 Series

### Table of Contents

ML2000 Series Overview.....	2
ML2000 Series Features .....	3-4
ML2000 Series Functions .....	5-9
ML20900 ECL Applications ...	10
ML20900 ECL Features .....	12
ML20900 ECL Functions .....	13
ML20600 NAC Series Electrified Mortise Lock with High Security Monitoring .....	14
NAC Functions.....	15-16
NAC How to Order .....	17
Trim Designs.....	18-39
Muséo® Trim.....	40
Muséo® Inspire™	
Roseless Trim .....	41
Muséo® Levers .....	42-54
Vineyard™ Collection Trim.....	55-57
High Security Trim (HS) .....	58
Vandal Resistant Trim (VR).....	59
Behavioral Health Trim (BHSS).....	60
Behavioral Health Lever Trim (BLSS).....	61
Push/Pull Trim (HPSK) .....	62
Anti-Harm Trim (HSS).....	63
Options and Accessories....	64-72
How to Order .....	73-75
Quick Codes .....	76-78
How to Specify .....	79-81
Reversing Handing .....	82

[www.corbinrusswin.com](http://www.corbinrusswin.com)

### Quality

The ML2000 Series is a Grade 1 mortise lock designed to meet the rigors of high-traffic commercial, institutional, industrial and government applications. Constructed of heavy-gauge steel, the lockbody features our patented Quick Reversible latchbolt, and a 1" stainless steel deadbolt. A wide variety of trim designs and functions and a 10-year warranty lend to the ML2000's versatility and reliability, making it the ideal choice for use in offices, schools, hospitals, hotels and other high-use applications.

### Security

Further discourage intrusion and abuse with the ML2000HS (High Security) or ML2000VR (Vandal Resistant) series mortise lock. Both locks feature vandal-resistant stainless steel escutcheons with tapered edges and Torx® pin tamper resistant screws. When matched with Corbin Russwin patented high-security cylinders, any door can become a formidable barrier to intruders.

### Aesthetics

Complement any application with the full range of trim designs and finishes offered with ML2000 Series. From stainless steel security trims to bright brass Vineyard™ levers, design continuum can be achieved without forfeiting aesthetics. For additional information regarding designer trim, see the Corbin Russwin Vineyard™ Collection and Muséo® Collection catalogs.

### Key Advantages

- Patented Quick Reversible feature enables reversal of hands without disassembling the lock case (Patent # 6,349,982)
- Security trims provide a vandal-resistant barrier
- Can be used with new or existing Corbin Russwin key systems. Also accepts cylinders of most other manufacturers.
- Provides life safety and security in a single door prep, saving the additional cost of a deadlock
- Through-bolted trim designs for proper alignment and increased security

### Features

#### Handing

Handed; quick reversible. The lockset can be re-handed without disassembling the lock case; see page 73.

#### Door Thickness

1-3/4" (44mm) standard.  
Optional door thicknesses available; see Quick Codes, page 77.

#### Backset

2-3/4" (70mm).

#### Lockcase

Heavy-gauge steel, 5-7/8" (149mm) x 4" (102mm) x 15/16" (24mm).  
Optional: non-ferrous lockcase for corrosion resistance; see Quick Codes, page 77.

#### Front

Heavy-gauge steel, 8" (203mm) x 1-1/4" (32mm) x -3/32" (2mm). Accommodates flat doors and doors beveled 1/8" (3mm) in 2" (51mm). Furnished 1-1/16" (27mm), optional D138, wide for 1-3/8" (35mm) doors.

#### Armored Front

Wrought brass, bronze or stainless steel attached by machine screws to lockcase front. ML2000HS & ML2000VR utilizes security Torx® screws.

#### Latchbolt

2-piece mechanical with anti-friction insert, 5/8" (16mm) x 1" (25mm) x 3/4" (19mm) throw.

#### Auxiliary Latchbolt

9/16" (14mm) effective throw and 3/8" (10mm) effective auxiliary latch deadlocking.

#### Deadbolt

One-piece stainless steel, 19/32" (15mm) x 1-1/4" (32mm) x 1" (25mm) throw.

#### Occupancy Indicator

Occupancy indicators for use with ML2000 x sectional trim. Design features option for dual indicators on double cylinder functions, confirming door is secured from either side. Emergency override standard for all non-keyed functions.

#### Hub

- Knob: stainless steel, 9/32" (7mm) x 9/32" (7mm). (HS) 3/8" (10mm) stainless steel.
- Lever: steel, 5/16" (8mm). (Including (VB))

#### Spacing

C. to c. knob/lever to cylinder: 3-5/8" (92mm).  
C. to c. knob/lever to thumbturn: 2-7/16" (62mm).

#### Strike

Wrought brass, bronze or stainless steel, ANSI straight lip standard, 4-7/8" (124mm) x 1-1/4" (32mm) x 1-1/8" (29mm) lip to center. Optional strikes, lip lengths and ANSI wrought strike box available; see Quick Codes, page 77.

#### Cylinder

Brass, 6-pin, L4 keyway, 0-bitted standard.  
Brass, fixed 6-pin conventional fixed core cylinder, L4 keyway standard for ML2000HS.  
Optional cylinders available; see Quick Codes, page 76.

#### Keys

Two nickel silver standard.

#### Keying Features Available

Master keying  
Construction master keying  
Visual key control  
Concealed key control  
Plug only to show (concealed shell)  
7-pin cylinder  
Security cylinder  
Access 3® cylinder  
Pyramid cylinder  
Interchangeable core (IC)  
Security IC  
Pyramid IC  
Access 3® IC  
Master ring cylinder  
Blockout cylinder  
Flex head cylinder

#### Warranty

Ten-year limited.

### Certification/Compliance

#### ANSI/BHMA

Certified A156.13 Series 1000, Operational and Security Grade 1. Meets A117.1 Accessibility Code.



#### Federal

Meets FF-H-106C.

#### UL/cUL-UL10C Positive Pressure

All locks listed for A label and lesser class doors, 4' (122cm) x 10' (305cm) single or 8' (244cm) x 10' (305cm) pair (3 hour fire door). Letter F and UL symbol on armored front indicate listing.

Any retrofit or other field modification to a fire rated opening can potentially impact the fire rating of the opening, and Corbin Russwin, Inc. makes no representations or warranties concerning what such impact may be in any specific situation. When retrofitting any portion of an existing fire-rated opening, or specifying and installing a new fire-rated opening, please consult with a code specialist or local code official (Authority Having Jurisdiction) to ensure compliance with all applicable codes and ratings.

#### California State Reference Code

(Formerly Title 19, California State Fire Marshal Standard)

All levers with returns, return to within 1/2" (13mm) of door face.

#### Windstorm/Hurricane

Certified (refer to local codes).

(HS) Indicates ML2000HS (High Security) availability.

(VB) Indicates ML2000VR (Vandal Resistant) availability.

# Features

## ML2000 Series

### Finishes

ANSI/BHMA 605 (US3)	(HS)	Bright Brass
ANSI/BHMA 606 (US4)	(HS)	Satin Brass
ANSI/BHMA 611 (US9)	(HS)	Bright Bronze
ANSI/BHMA 612 (US10)	(HS)	Satin Bronze
ANSI/BHMA 613 (US10B)	(HS)	Oxidized Bronze, oil rubbed
613E (US10BE)		Dark Oxidized Satin Bronze - Equivalent
613L		Dark Oxidized Satin Bronze, Clear Coated
ANSI/BHMA 618 (US14)		Bright Nickel Plated
ANSI/BHMA 619 (US15)	(HS)	Satin Nickel Plated
ANSI/BHMA 625 (US26)	(HS)	Bright Chromium Plated
ANSI/BHMA 626 (US26D)	(HS)	Satin Chromium Plated
626C		Satin Chromium Plated with MicroShield®
ANSI/BHMA 629 (US32)	(VR)	Bright Stainless Steel
ANSI/BHMA 630 (US32D)	(VR)	Satin Stainless Steel
630C	(HS)	Satin Stainless Steel with MicroShield®
722		Black Oxidized Bronze, oil rubbed



Highly engineered 3 spring design for smooth, crisp, and responsive operation



















(HS) Indicates ML2000HS (High Security) availability.

(VR) Indicates ML2000VR (Vandal Resistant) availability.

# Functions

## ML2000 Series

Outside	Inside	Series/Function	Type	ANSI No.	Function Description
 A01	 A01	ML2022 (HS) (VR) (HSS)	Store Door	F14	<ul style="list-style-type: none"> <li>Latchbolt by grip* either side when deadbolt is retracted.</li> <li>Deadbolt by key either side.</li> <li>Non-panic release.</li> <li>No simultaneous deadbolt and latch retraction</li> </ul>
 A01	 A01	ML2024 (HS) (VR) (HSS)	Entrance or Storeroom	F21	<ul style="list-style-type: none"> <li>Latchbolt by grip* either side when deadbolt is retracted.</li> <li>Deadbolt by key outside or by thumbturn grip inside.</li> <li>Non-panic release.</li> <li>No simultaneous deadbolt and latch retraction</li> </ul>
 A01 (Hotel Cylinder)	 A01	ML2029 (VR)	Hotel or Motel	F15	<ul style="list-style-type: none"> <li>Latchbolt by grip inside and by guest key or master key outside.</li> <li>Outside grip always rigid.</li> <li>Deadbolt by thumbturn grip inside or by emergency key outside.</li> <li>Inside grip simultaneously retracts latchbolt and deadbolt.</li> <li>Emergency key shuts out all other keys.</li> <li>Auxiliary latch deadlocks latchbolt.</li> </ul> <p>Note: Indicator shows deadbolt position only</p>
 A01 (Hotel Cylinder)	 A01	ML2029HS (HS)	Hotel or Motel	—	<ul style="list-style-type: none"> <li>Latchbolt by grip inside and by guest key or master key outside.</li> <li>Outside grip always rigid.</li> <li>Emergency key throws deadbolt, shutting out all other keys and preventing exit from inside.</li> <li>Auxiliary latch deadlocks latchbolt.</li> </ul> <p>Note: Indicator shows deadbolt position only</p>
 A01	 A01	ML2030 (HS) (VR)	Privacy Bedroom or Bathroom	F19	<ul style="list-style-type: none"> <li>Latchbolt by grip either side unless outside grip locked by thumbturn</li> <li>Deadbolt by thumbturn grip inside or by emergency release tool outside.</li> <li>Inside grip simultaneously retracts latchbolt and deadbolt and unlocks outside grip.</li> <li>Not available with M19S or M19SN</li> </ul>
 A01	 A01	ML2032 (HS) (VR) (HSS)	Institution or Utility	F30	<ul style="list-style-type: none"> <li>Latchbolt by key either side.</li> <li>Both grips always rigid.</li> <li>Auxiliary latch deadlocks latchbolt.</li> </ul> <p>Note: This function does not allow free egress and can pose a life safety hazard in event of an emergency. Installation should be in accordance with approved codes only.</p>
 A01	 A02	ML2042 (HS) (VR) (HSS)	Entrance or Public Restroom	F09	<ul style="list-style-type: none"> <li>Latchbolt by grip either side, unless outside grip is locked by key from inside.</li> <li>Latchbolt by key outside when outside grip is locked.</li> <li>Auxiliary latch deadlocks latchbolt.</li> <li>Inside grip always free.</li> </ul>
 A01	 A01	ML2048 (HS) (VR)	Entrance or Apartment	F08 F10	<ul style="list-style-type: none"> <li>Latchbolt* by key outside or by grip either side, unless outside grip is locked by toggle-action stop.</li> <li>Deadbolt by key outside or by thumbturn grip inside.</li> <li>Inside grip free when deadbolt is retracted.</li> <li>Non-panic release.</li> <li>No simultaneous deadbolt and latch retraction</li> </ul> <p>Note: Indicator shows deadbolt position only</p>
		ML2050	Half Dummy Trim	—	<ul style="list-style-type: none"> <li>Grip acts as pull only; no operation.</li> </ul>

\* When lever handles are furnished, both outside and inside are locked when deadbolt is projected.

 Indicates Indicator option is available

(HS) Indicates function availability in ML2000HS.

 Indicates Indicator option is available

(VR) Indicates function available in Vandal Resistant Trim.

(HSS) Indicates function available in Anti-Harm Trim.

 Indicates rigid grip.

ML2000.6

ASSA ABLOY, the global leader in door opening solutions

# Trim Designs

## ML2000 Series, ML20900 ECL and ML20600 NAC



### Lustra

Complies with codes requiring lever to return to within 1/2" (13mm) of door face. Brass, bronze or stainless steel.



#### LWA

Lever: Wrought  
Rose: Wrought

#### LWB

Lever: Wrought  
Rose: Cast



#### LSA

Lever: Cast  
Rose: Wrought

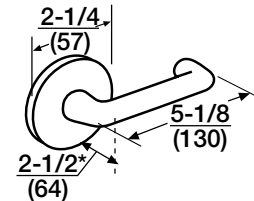

#### LSB

Lever: Cast  
Rose: Cast

#### LWF

Lever: Wrought  
Rose: Cast



#### LSF

Lever: Cast  
Rose: Cast

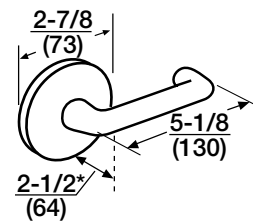

Dimensions:

inches  
millimeters

\*Dimension from face of door, not surface of rose or escutcheon.

# How to Order

## ML2000 Series

### Ordering Examples - ML2000 Series

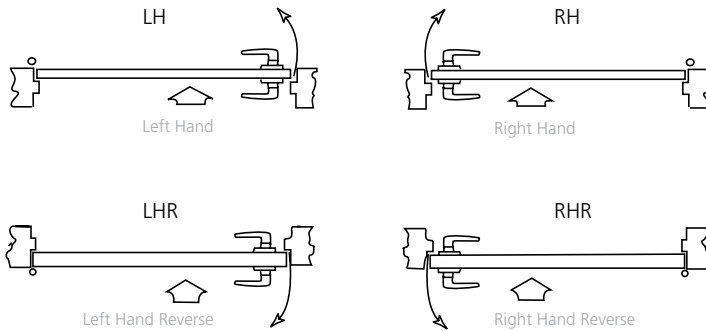

Note: Arrow indicates secure side of door.

### Where to find ordering information and Quick Codes

ML2000 Series/Function	5-9
ML20900 ECL Series/Function	13
Trim Designs	14-54
Cylinder and Keying	69
Finish	69
Strikes	70
Miscellaneous Options	70
Door Thickness	70
Handing	71

### Stock Order

Quantity	Series/Function	Trim	Finish	Hand
100	ML2055	LWA	626	RHR
50	ML2055HS	SST	626	LHR

### Split Trim / Finish Order

Quantity	Series/Function	Trim		Finish		Hand
		Outside	Inside	Outside	Inside	
12	ML2055	LWA	GRC	626	625	RHR
6	ML2055HS	SST	—	626	606	LHR
12	ML2055	ZSL	—	626	625	RHR
24	ML2051	MSG	—	605	625	LH
12	ML2055	102U	—	626	606	RHR
24	ML2051	122R	110R	605	625	LH

### Contract / Detailed Order

Quantity	Keyset	Series/Function	Trim	Finish	Hand	Door Thickness	Optional Strike	Misc. Options	Optional Cylinder	Keying
24	AA1	ML2055	LWA	626	RHR	D214	SA200	M17-M26	C7	VKC3
12	AA1	ML2055HS	SST	626	LHR	D214	SS200	M07	C6	VKC1
6	AA1	ML2055VR	NSV	630	RH	D214	SS114	M17	PCHS	VKC1

### Working Trim Only

Quantity	Function Only	Trim	Finish	Hand	Door Thickness	Misc. Options
6	ML2055	LWA	626	RHR	D214	M31
3	ML2055HS	SST	626	LHR	D214	M31
1	ML2055VR	NSV	630	RH	D214	M31

(Includes grip and spindle, rose or escutcheon, thumbturn lever, emergency key plate, adapters and screws)

# Quick Codes

## ML2000 Series, ML20900 ECL and ML20600 NAC

### Cylinder and Keying

Description	Specify
Conventional 6-pin <sup>(HS)</sup> <sup>(VR)</sup>	(standard)
Conventional 7-pin <sup>(HS)</sup> <sup>(VR)</sup>	7P
Less cylinder(s) <sup>(HS)</sup> <sup>(VR)</sup>	LC
IC 6-pin <sup>(HS)</sup> <sup>(VR)</sup>	C6
IC 6-pin with temporary construction core <sup>(HS)</sup> <sup>(VR)</sup>	
Red	CT6R
Blue	CT6B
Green	CT6G
IC 6-pin less core <sup>(HS)</sup> <sup>(VR)</sup>	CL6
SFIC 6-pin with SFIC disposable temporary core <sup>1</sup> <sup>(HS)</sup> <sup>(VR)</sup>	CT6SD
SFIC 6-pin with Less Core <sup>1</sup> <sup>(HS)</sup> <sup>(VR)</sup>	CLS6
IC 7-pin <sup>(HS)</sup> <sup>(VR)</sup>	C7
IC 7-pin with temporary construction core <sup>(HS)</sup> <sup>(VR)</sup>	
Red	CT7R
Blue	CT7B
Green	CT7G
IC 7-pin less core <sup>(HS)</sup> <sup>(VR)</sup>	CL7
SFIC 7-pin with SFIC disposable temporary core <sup>1</sup> <sup>(HS)</sup> <sup>(VR)</sup>	CT7SD
SFIC 7-pin with Less Core <sup>1</sup> <sup>(HS)</sup> <sup>(VR)</sup>	CLS7
Security <sup>(HS)</sup> <sup>(VR)</sup>	HS
Security IC <sup>(HS)</sup> <sup>(VR)</sup>	CHS
Access 3 - Patented <sup>(HS)</sup> <sup>(VR)</sup>	AP
Access 3 - Security <sup>(HS)</sup> <sup>(VR)</sup>	AS
Access 3 - High Security <sup>(HS)</sup> <sup>(VR)</sup>	AHS
Access 3 IC - Patented <sup>(HS)</sup> <sup>(VR)</sup>	ACP
Access 3 IC - Security <sup>(HS)</sup> <sup>(VR)</sup>	ACS
Access 3 IC - High Security <sup>(HS)</sup> <sup>(VR)</sup>	ACHS
UL IC 6-Pin Housing Less Core	CL6AH
UL IC 6-Pin Housing with Disposable Core	CTAHD
UL IC 6-Pin Housing with (Red/Blue/Green) Temporary Construction Core	CT6AH(R/B/G)
Pyramid High Security Fixed Core <sup>(HS)</sup> <sup>(VR)</sup>	PHS
Pyramid High Security IC <sup>(HS)</sup> <sup>(VR)</sup>	PCHS
Pyramid IC Less Core <sup>(HS)</sup> <sup>(VR)</sup>	CLP
Pyramid with temporary <sup>(HS)</sup> <sup>(VR)</sup> construction core	CTP
Pyramid Security <sup>(HS)</sup> <sup>(VR)</sup>	PS
Pyramid Security IC <sup>(HS)</sup> <sup>(VR)</sup>	PCS
Pyramid Disposable Core <sup>(HS)</sup> <sup>(VR)</sup>	CTPD
6-Pin Disposable Core <sup>(HS)</sup> <sup>(VR)</sup>	CT6D
7-Pin Disposable Core <sup>(HS)</sup> <sup>(VR)</sup>	CT7D
Master ring <sup>2</sup> <sup>(HS)</sup> <sup>(VR)</sup>	MR
Blockout function cylinder <sup>(HS)</sup> <sup>(VR)</sup>	BO
Flex head cylinder, 6-pin (sectional trim)	FX6
Flex head cylinder, 7-pin (sectional trim)	FX7
Flex head cylinder, master ring <sup>2</sup> (sectional trim)	FXM
Plug only to show, 6-pin (concealed shell; M and R escutcheons only, single cylinder only)	PO6
Plug only to show, 7-pin (concealed shell; M and R escutcheons only, single cylinder only)	PO7
Plug only, less cylinder	PO-LC

<sup>(HS)</sup> Indicates cylinder is available with ML2000HS lockset

<sup>(VR)</sup> Indicates availability with ML2000VR lockset

ML2000.76

Description	Specify
Keyed random <sup>(HS)</sup> <sup>(VR)</sup>	KR
Construction master keyed (not available for Pyramid) <sup>(HS)</sup> <sup>(VR)</sup>	CMK
Visual key control <sup>(HS)</sup> <sup>(VR)</sup>	
- No keying data stamped on key or cylinder	VKC0
- Keys only	VKC1
- Cylinders and keys (not for HS, CHS, PHS, PCHS, AS, ACS, AHS, or ACHS)	VKC2
- Cylinders only (not for HS, CHS, PHS, PCHS, AP, ACP, AS, ACS, AHS or ACHS)	VKC3
Concealed key control (CKC) <sup>(HS)</sup> <sup>(VR)</sup>	
- CKC cylinders with VKC keys	CKC2
- CKC cylinders only (not for HS, CHS, PHS, PCHS, AP, ACP, AS, ACS, AHS or ACHS)	CKC3
2 keys per lock More than 2 keys	(standard) KY# (e.g., KY6)

1. Not available with ML2029.

2. Not available for ML2017, ML2029, ML2000HS or ML2000VR.

### Finishes

ANSI/BHMA 605 (US3)	<sup>(HS)</sup>	Bright Brass
ANSI/BHMA 606 (US4)	<sup>(HS)</sup>	Satin Brass
ANSI/BHMA 611 (US9)	<sup>(HS)</sup>	Bright Bronze
ANSI/BHMA 612 (US10)	<sup>(HS)</sup>	Satin Bronze
ANSI/BHMA 613 (US10B)	<sup>(HS)</sup>	Oxidized Bronze, oil rubbed
613E (US10BE)		Dark Oxidized Satin Bronze - Equivalent
613L		Dark Oxidized Satin Bronze, Clear Coated
ANSI/BHMA 618 (US14)		Bright Nickel Plated
ANSI/BHMA 619 (US15)	<sup>(HS)</sup>	Satin Nickel Plated
ANSI/BHMA 625 (US26)	<sup>(HS)</sup>	Bright Chromium Plated
ANSI/BHMA 626 (US26D)		Satin Chromium Plated
626C		Satin Chromium Plated with MicroShield®
ANSI/BHMA 629 (US32)	<sup>(HS)</sup>	Bright Stainless Steel
ANSI/BHMA 630 (US32D)	<sup>(HS)</sup> <sup>(VR)</sup>	Satin Stainless Steel
630C		Satin Stainless Steel with MicroShield®
722		Black Oxidized Bronze, oil rubbed