

GV-RFER12700 12MP H.265 Super Low Lux WDR IR Fisheye IP Camera



Introduction

GV-RFER12700 is a 12 MP outdoor fisheye camera allowing you to monitor all angles of a location and can be installed to the ceiling or the wall. The camera supports H.265 video codec to achieve better compression ratio while maintaining high quality image at reduced network bandwidths. The camera adheres to IP66 standard and can be powered through PoE.

Key Features

- 1/2.3" progressive scan CMOS sensor
- Min. illumination at 0.01 lux
- Triple streams from H.265, H.264
- Up to 15 fps at 3840 x 3000
- Day and Night function (with removable IR-cut filter)
- Intelligent IR
- IR distance up to 10 m (35 ft)
- Ingress protection (IP66)
- Built-in micro SD card slot (SD/SDHC/SDXC/UHS-I, Class 10) for local storage
- Two-way audio
- Built-in microphone and speaker
- One sensor input and one alarm output
- DC 12V/ PoE (IEEE 802.af)
- Provides 360° and 180° panorama view
- Wide Dynamic Range (WDR)
- 3D noise reduction
- Motion detection
- Tampering alarm
- Privacy mask
- Text overlay
- 12 languages supported
- ONVIF (Profile G, S, T) conformant

Dimensions

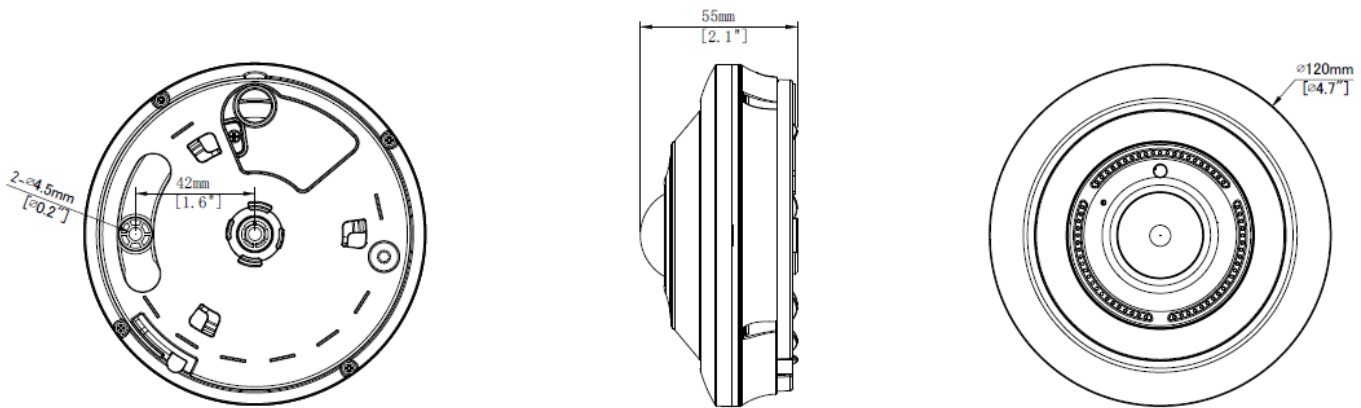

Specifications

Camera					
Image Sensor	1/2.3" progressive scan CMOS				
Picture Elements	3840 (H) x 3000 (V)				
Minimum Illumination	Color	0.01 Lux (F1.6, AGC ON)			
	IR On	0 Lux			
Shutter Speed	Auto / Manual (1 ~ 1/30000 sec)				
White Balance	Auto / Manual				
Gain Control	Auto, Manual				
S/N Ratio	39.5 dB				
WDR	Yes				
Optics Lens					
Megapixel	Yes				
Day/Night	Yes (with removable IR-cut filter)				
Lens Type	Fixed				
Focal Length	1.6 mm				
Maximum Aperture	F/2				
Mount	M12				
Image Format	1/2.3"				
Horizontal FOV	180°				
Operation	Focus	Fixed			
	Zoom	Fixed			
	Iris	Fixed			
IR LED Quantity	3 IR LEDs				
Max. IR Distance	10 m (35 ft)				
DORI		Detect	Observe	Recognize	Identify
Lens	1.6 mm	41.3 m (135.4 ft)	16.5 m (54.1 ft)	8.3 m (27.2 ft)	4.1 m (13.4 ft)
Operation					
Video Compression	H.265, H.264				
Video Streaming	Triple streams from H.265 & H.264				
Frame Rate	25 fps at 3000 x 3000, 2560 x 2560, 2160 x 2160, 1520 x 1520, 480 x 480 (50 / 60 Hz) 15 fps at 3840 x 3000, 1280 x 960, 640 x 480 (50 / 60 Hz) *The frame rate and the performance may vary depending on the number of connections and data bitrates (different scenes).				
Video Analytics	Motion Detection, Audio Alarm *Tamper detection and audio alarm are only accessible through the camera's Web interface, which can be used to trigger alerts such as e-mail and FTP				

Image Setting		Brightness, Contrast, Saturation, Sharpness, IR-CUT Mode, IR CUT Delay, IR-LED Low Beam Light, Angle Trad, White Balance, Shutter, Time Exposure, 3D Noise Reduction, WDR, White Balance, Display Mode, Image Orientation (Flip, Mirror, 90°, 180° - including Corridor format).
Software Dewarping	Ceiling Mount	Fisheye View, Cylinder, 2 PTZ, 4 PTZ, 180° panorama image, 360° panorama image, 360° panorama image and PTZ, 360° panoramic image and 3 PTZ, 360° panoramic image and 6 PTZ, 360° panoramic image and 8PTZ, Fisheye and 3 PTZ, Fisheye and 8 PTZ
	Wall	Fisheye View, Panorama, 4 PTZ, 360° panoramic image and 3 PTZ, 360° panoramic image and 8 PTZ, Fisheye and 3 PTZ, Fisheye and 8 PTZ
	Desktop	Fisheye View, Cylinder, 4 PTZ, 180° panorama image, 360° panorama image, 360° panorama image and PTZ, 360° panoramic image and 3 PTZ, 360° panoramic image and 6 PTZ, 360° panoramic image and 8 PTZ
	Tilt	Fisheye View, Panorama, 4 PTZ, 360° panoramic image and 3 PTZ, 360° panoramic image and 8 PTZ, Fisheye and 3 PTZ, Fisheye and 8 PTZ
Audio Compression		G.711
Audio Support		Two-way Audio
Digital I/O	Input	1 Input, dry contact, NO / NC
	Output	1 Relay Output (2A 30V DC / 0.5A 125V AC)
Video Resolution		
Video Resolution	Main Stream	3840 x 3000, 3000 x 3000 (Default), 2560 x 2560, 2160 x 2160, 1520 x 1520
	Sub Stream	1280 x 960 (Default), 640 x 480, 480 x 480
	Third Stream (Closed by Default)	640 x 480, 480 x 480
Network		
Interface		10/100 Ethernet
Protocol		802.1x, DDNS, DHCP, DNS, FTP, HTTP, HTTPS, IPv4, IPv6, NTP, ONVIF (Profile G, S, T), RTP/RTSP, SMTP, SNMP, TCP, UPnP
Mechanical		
Connectors	Power	DC Jack
	Ethernet	RJ-45
	Audio	1 in (built-in microphone), 1 out (built-in speaker)
	Digital I/O	4-pin terminal block pitch 3.5 mm (0.14")
	Local Storage	Micro SD card slot (SD/SDHC/SDXC/UHS-I, Class 10), up to 256 GB *UHS-II card type is not supported.
General		
Operating Temperature		-35°C ~ 60°C (-31°F ~ 140°F)
Humidity		0% ~ 90% (no condensation)
Power Source		12V DC / PoE (IEEE 802.3af)
Max. Power Consumption		9.6 W
Dimension		Ø 120 x 55 mm (4.7" x 2.1")
Weight		400 g (0.88 lb)
Ingress Protection		IP66
Certification		CE, FCC, RoHS compliant
Web Interface		
Installation Management		Web-based configuration
Maintenance		Firmware upgrade through Web Browser or GV-IP Device Utility
Language		English, German, Spanish, French, Japanese, Italian, Portuguese, Russian, Turkish, Traditional Chinese, Korean, Ukrainian
Applications		
Software Supported		GV-VMS (V17.4.7 / V18.3.2, patch files required), GV-Control Center (V4.3, coming soon), GV-Recording Server / Video Gateway (V2.2, coming soon), GV-Edge Recording Manager Win version (V2.3, coming soon)
Smart Device Access		GV-Eye for iOS and Android (V3.2.0, coming soon)
Live Viewing		Browser (IE, Edge, Chrome, Firefox, Safari), Mobile App







Note:

- To avoid reflected glare by IR LED, keep a minimum distance of 1 M (3.28 ft) between the camera body and nearby walls.
- Fisheye dewarping is only applicable on Internet Explorer or Internet Explorer mode on Microsoft Edge.
- All specifications are subject to change without notice.

Packing List

1. GV-RFER12700 Fisheye Camera
2. Waterproof Rubber Set
3. Screw Kit
4. Drill Template Paster
5. Download Guide

Accessories

Model No.	Name		Details
GV-Mount108 (must be used with GV-Mount504-1)	Straight Tube		Dimensions: H=294 mm (11.5") Weight: 0.7 g (1.54 lb)
GV-Mount210-2 (must be used with GV-Mount504-1)	Wall Pendant Mount		Dimensions: 169 x 98 x 180 mm (6.5" x 3.8" x 7") Weight: 0.5 g (1.1 lb)
GV-Mount213-1	Wall Box Mount		Dimensions: Ø 126 x 48.9 mm (4.9" x 1.9") Weight: 0.25 g (0.55 lb)
GV-Mount311 (must be used with GV-Mount213-1)	Corner Adaptor		Dimensions: 172.8 x 271.4x 200 mm (6.8" x 10.68" x 7.87") Weight: 2.35 g (5.18 lb)
GV-Mount504-1 (must be used with GV-Mount108 or GV-Mount210-2)	Wall Mount Bracket		Dimension: Ø 126 x 68.9 mm (4.9" x 2.7") Weight: 0.3 kg (0.66 lb)
GV-PA191	PoE Adapter		GV-PA191 is a Power over Ethernet (PoE) adapter designed to provide power to the IP device through a single Ethernet cable.
GV-PA301	Gigabit PoE Adapter		GV-PA301 is a Gigabit Power over Ethernet (PoE) adapter.
GV-PoE Switch			GV-PoE Switch is designed to provide power along with network connection for IP devices. GV-PoE Switch is available in various models with different numbers and types of ports.

Power Adapter

Contact our sales representatives for the countries and areas supported.
