

GV-TBL4705 4MP H.265 Super Low Lux WDR Pro IR Bullet IP Camera



- 1/3" progressive scan super low lux CMOS sensor
- Min. illumination at 0.003 lux
- Dual streams from H.265, H.264 or MJPEG
- Up to 30 fps at 2688 x 1520
- Intelligent IR
- IR distance up to 50 m (165 ft)
- Built-in microphone
- Built-in micro SD card slot (SD / SDHC / SDXC / UHS-I) for local storage
- Day and night function (with removable IR-cut filter)
- Ingress protection (IP67)
- DC 12V / PoE (IEEE 802.3af)
- Wide Dynamic Range Pro (WDR Pro)
- Defog
- 3D noise reduction
- Motion detection
- Text overlay
- Privacy mask
- 12 languages supported
- ONVIF (Profile G, S, T) conformant

Introduction

The Bullet IP Camera is an outdoor network camera equipped with an automatic IR-cut filter and IR LEDs for day and night surveillance. The camera supports H.265 video codec to achieve better compression ratio while maintaining high quality pictures at reduced network bandwidths. It adheres to IP67 standards and can be powered through PoE.

Dimensions

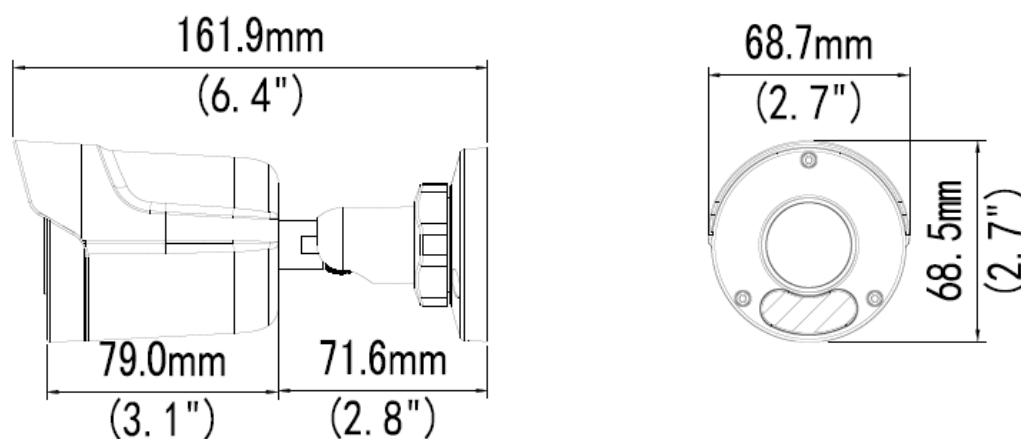

Specifications

Camera		
Image Sensor		1/3" progressive scan super low lux CMOS
Picture Elements		2688 (H) x 1520 (V)
Minimum Illumination	Color	0.003 Lux (F1.6, AGC ON)
	IR ON	0 Lux
Shutter Speed		Auto / Manual (1 ~ 1/100000s)
White Balance		Auto / Manual
Gain Control		Auto / Manual
S/N Ratio		56 dB
WDR Pro		Yes
Dynamic Range		120 dB

Lens					
Megapixel	4 MP				
Day / Night	Yes (with removable IR-cut filter)				
Lens Type	Fixed				
Focal Length	4 mm				
Maximum Aperture	F/1.6				
Mount	M12				
Horizontal FOV	83.7°				
Operation	Focus	Fixed			
	Zoom				
	Iris				
IR LED Quantity	2 IR LED				
Max. IR Distance	50 m (165 ft)				
DORI		Detect	Observe	Recognize	Identify
Lens	4 mm	90 m (295.3 ft)	36 m (118.1 ft)	18 m (59.1 ft)	9 m (29.5 ft)
Operation					
Video Compression	H.265, H.264, MJPEG				
Video Streaming	Dual streams from H.265, H.264 or MJPEG				
Video Resolution	Main Stream	2688 x 1520 (Default), 2560 x 1440, 2304 x 1296, 1920 x 1080, 1280 x 720			
	Sub Stream	1280 x 720, 720 x 576, 640 x 480, 640 x 360 (Default)			
Frame Rate	30 fps at 2688 x 1520 (60 / 50 Hz) * The frame rate and performance may vary depending on the number of connections and data bitrates (different scenes).				
Video Analytics	Motion Detection, Tampering Alarm , Audio Detection , Cross Line, Intrusion *Tampering Alarm, Audio Detection, Cross Line, Intrusion are only accessible through the camera's Web interface, which can be used to trigger alerts such as e-mail and FTP				
Image Setting	Brightness, Contrast, Saturation, Sharpness, Flicker-less, Image Orientation (Flip, Mirror, 0°, 90°, 180°, 270°-including Corridor format)				
Audio Compression	G.711				
Audio Support	One-way Audio				
Network					
Interface	10/100 Ethernet				
Protocol	802.1x, ARP, DHCP, DDNS, DNS, DynDNS, FTP, HTTP, HTTPS, ICMP, IGMP, IPv4, IPv6, NTP, PPPoE, QoS, RTCP, RTP, RTSP, SMTP, SNMP, TCP, UDP, UPnP, ONVIF (Profile G, S, T)				
Mechanical					
Temperature Detector	No				
Camera Angle Adjustment	Pan	0° ~ 360°			
	Tilt	0° ~ 90°			
	Rotate	0° ~ 360°			
Connectors	Power	DC Jack (DC 12 V, 1.25 A), PoE			
	Ethernet	RJ-45 connector			
	Audio	1 In (built-in microphone)			
	Local Storage	Micro SD card slot (SD/SDHC/SDXC/UHS-I, Class 10) *UHS-II card type is not supported.			
General					
Operating Temperature	-30°C ~ 60°C (-22°F ~ 140°F)				
Humidity	0% ~ 95% (no condensation)				
Power Source	12 V DC / PoE (IEEE802.3af)				
Max. Power Consumption	6 W				
Dimensions	161.9 × 68.7 × 68.5 mm (6.4" × 2.7" × 2.7")				
Weight	0.45 kg (0.99 lb)				
Ingress Protection	IP67				
Certification	CE, FCC, RoHS, UL compliant				
Web Interface					
Installation Management	Web-based configuration				

Maintenance	Firmware upgrade through Web Browser or GV-IP Device Utility
Access from Web Browser	Live View, Video Recording, Change Video Quality, Bandwidth Control, Image Snapshot, Defog, Text Overlay, Image Masking
Language	Czech, English, French, German, Hungarian, Italian, Japanese, Polish, Portuguese, Russian, Spanish, Traditional Chinese
Applications	
Software Supported	GV-VMS (V17.4.1 / V18.2.1), GV-DVR / NVR (V8.9.1), GV-Control Center (V3.8.0), GV-Recording Server / Video Gateway (V2.0.0), GV-Edge Recording Manager Win version (V2.0.0), GV-Redundant / Failover Server (V1.2.0), GV-Mobile Server (V1.5.0.0)
Smart Device Access	GV-Eye for iOS and Android
Live Viewing	Browser (IE, Edge, Chrome, Firefox), Mobile App





Note:



1. It is required to apply patch files to some or all of the supported software.
2. Do not use clothes or any ordinary material to clean the camera cover since they may result in scratches.
3. Specifications are subject to change without notice.

Packing List

- | | |
|--------------------------|--------------------------|
| 1. GV-TBL4705 Bullet | 4. Drill Template Paster |
| 2. Waterproof Rubber Set | 5. Download Guide |
| 3. Screw Kit | 6. Warranty Card |

Accessories

Model No.	Name		Details
GV-Mount300-2 (must be used with GV-Mount504)	Convex Corner Mount		Dimensions: 137 x 233 x 160 mm (5.4" x 9.17" x 6.3") Weight: 1.65 kg (3.64 lb)
GV-Mount310-2 (must be used with GV-Mount504)	Concave Corner Mount		Dimensions: 111.2 x 369.9 x 210 mm (2.6" x 11.4" x 6.6") Weight: 1.65 kg (3.64 lb)
GV-Mount440 (must be used with GV-Mount504)	Pole Mount		Dimensions: 127 x 136 x 62.5 mm (5" x 5.35" x 2.46") Weight: 0.34 kg (0.75lb) Steel Strap Diameter: Ø 67 ~ 127 mm (Ø 2.6" ~ 5")
GV-Mount504	Wall Mount Bracket		Dimensions: Ø 104.4 x 54.5 mm (Ø 4.11" x 2.15") Weight: 0.36 kg (0.79 lb)

<p>GV-Mount924(for standard US single and double gang boxes only)</p>	<p>Power Box Mount Bracket</p>		<p>Dimensions: Ø 128 x 18.5 mm (Ø 5" x 0.7") Weight: 0.15 kg (0.33 lb)</p>
<p>GV-PA191</p>	<p>Power over Ethernet (PoE) Adapter</p>		<p>GV-PA191 is a Power over Ethernet (PoE) adapter designed to provide power to the IP device through a single Ethernet cable.</p>
<p>GV-POE Switch</p>	<p>GV-POE Switch is designed to provide power along with network connection for IP devices. GV-POE Switch is available in various models with different numbers and types of ports.</p>		
<p>Power Adapter</p>	<p>Contact our sales representatives for the countries and areas supported.</p>		