

GV-FR Panel

User's Manual



Before attempting to connect or operate this product, please read these instructions carefully and save this manual for future use.



© 2024 GeoVision, Inc. All rights reserved.

Under the copyright laws, this manual may not be copied, in whole or in part, without the written consent of GeoVision.

Every effort has been made to ensure that the information in this manual is accurate. GeoVision, Inc. makes no expressed or implied warranty of any kind and assumes no responsibility for errors or omissions. No liability is assumed for incidental or consequential damages arising from the use of the information or products contained herein. Features and specifications are subject to change without notice.

GeoVision, Inc.
9F, No. 246, Sec. 1, Neihu Rd.,
Neihu District, Taipei, Taiwan
Tel: +886-2-8797-8377
Fax: +886-2-8797-8335
<http://www.geovision.com.tw>

Trademarks used in this manual: *GeoVision*, the *GeoVision* logo and *GV* series products are trademarks of GeoVision, Inc. *Windows* is a registered trademark of Microsoft Corporation.

April 2024

Contents

Regulatory Notices	iii
Recognition and Authentication Considerations	iv
Important Notices	v
Note for Weigand Connection	v
Chapter 1 Introduction	1
1.1 Key Features.....	2
1.2 Packing List.....	3
1.3 Options.....	4
1.4 Firmware and Software Compatibility	4
1.5 Overview	5
1.6 Connecting GV-FR Panel	6
1.7 Standard Installation.....	7
Chapter 2 Getting Started	9
2.1 Accessing GV-FR Panel.....	9
2.2 Looking Up the IP address	10
2.3 Local Settings.....	12
Chapter 3 Access Control Integration	16
3.1 Setting up GV-ASManager	17
3.1.1 Adding GV-Controller	17
3.1.2 Setting GV-FR Panel to be a Door	19
Chapter 4 User Management on GV-ASManager and GV-FR Panel.....	21
4.1 Adding User Faces & Cards on GV-ASManager	22
4.2 Uploading to GV-FR Panel	24
4.3 Using GV-FR Panel.....	26

4.3.1 Face Only Mode.....	26
4.3.2 Card or Face Mode	27
4.3.3 Card + Face Mode	27
Chapter 5 Administrator Mode	28
5.1 General Settings.....	28
5.1.1 System Settings	28
5.1.2 Account & Authority.....	30
5.1.3 Recognition Settings	30
5.1.4 Relay Settings.....	31
5.2 Face Management	32
5.2.1 Face Profiles	32
5.3 Notify Settings	34
5.3.1 GV-FWC/Controller	34
5.3.2 Event Trigger	35
5.4 Event Query	37
Chapter 6 Advanced Applications	38
6.1 Upgrading System Firmware	38
6.2 Restoring to Factory Default Settings	40
6.3 GV-Face Manager for Face Database Management	40
Chapter 7 Third-Party Controller Integration	42
7.1 Via Onboard Wiegand Interface.....	42
7.2 Via GV-FWC Converter	43
Chapter 8 Live Streaming on GV-Software.....	46
Specifications	47
Appendix	47
Verifying the Connection between GV-FR Panel and GV-AS Controller	47
Optional Installation.....	48
GV-Mount800	48
GV-Mount801	50
GV-Mount920	59

Regulatory Notices



FCC Notice

This equipment has been tested and found to comply with the limits for a Class A digital device, pursuant to part 15 of the FCC Rules. These limits are designed to provide reasonable protection against harmful interference when the equipment is operated in a commercial environment.

Class A

This equipment generates, uses, and can radiate radio frequency energy and, if not installed and used in accordance with the instruction manual, may cause harmful interference to radio communications. Operation of this equipment in a residential area is likely to cause harmful interference in which case the user will be required to correct the interference at their own expense.

CE Notice

This is a Class A product. In a domestic environment, this product may cause radio interference in which case the user may be required to take adequate measures.

RoHS RoHS Compliance

The Restriction of Hazardous Substances (RoHS) Directive is to forbid the use of hazardous materials of production. To meet the RoHS Directive requirements, this product is made to be RoHS compliant.



WEEE Compliance

This product is subject to the Waste Electrical and Electronic Equipment (WEEE) Directive and made compliant with the WEEE requirements.

Recognition and Authentication Considerations

Face Recognition Distance:

- GV-FR Panel delivers optimal face recognition results when the faces of the targets are within 1 meter (3 ft) of the GV-FR Panel.

Lighting Conditions:

- GV-FR Panel is designed for indoor use only. Avoid exposing it to direct sunlight as it may affect its face recognition performance.

Face Recognition Limitations:

- GV-FR Panel may not be able to recognize faces wearing any type of sunglasses.

Detection Area of Cards, Tags / Fobs, QR Codes:

- When swiping **cards**, place them **closely** against the touch screen for optimal detection effect.
- When swiping **tags / fobs**, place them **closely** against the text “NFC” on the touch screen for optimal detection effect.
- When scanning **QR codes**, keep a distance of 10-15 cm (4-6 in) from the reader for effective scanning.

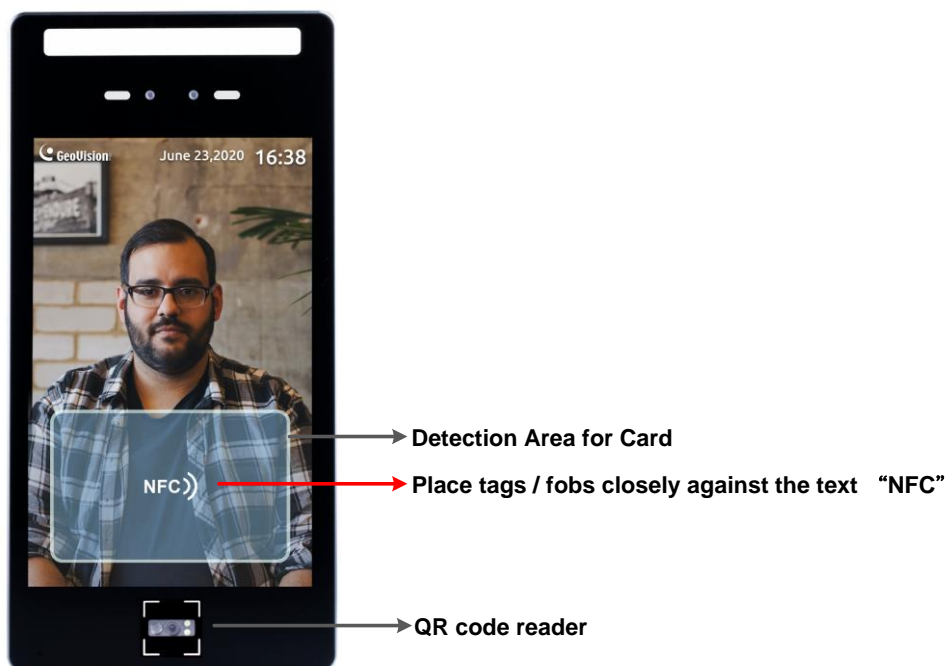

Important Notices

1. GV-FR Panel will automatically load default when downgraded to an older version.
2. After upgrading to V1.20, make sure to set the network setting to DHCP and connect the panel to Internet for license authentication.
3. After upgrading to version V1.20, a loading screen displaying “Data migration” will appear and face recognition will remain non-functional until the system completes upgrading.

Note for Weigand Connection

When connecting via Wiegand, the Ground (GND) wire must be connected alongside the Wiegand Data wires.

Chapter 1 Introduction

GV-FR Panel is a face-recognition-based access reader, with an 8" LCD touchscreen that displays 800 x 1280 HD images. When connected to GeoVision access control systems, GV-FR Panel can grant or deny access based on a variety of credentials including face recognition, access cards and card + face double authentication. Additionally, GV-FR Panel can read QR codes from GV-ASManager's Visitor Management System (GV-VMWeb) as well as the EU Digital COVID Certificate.

GV-FR Panel, with cutting-edge face recognition ability, can be integrated into any third-party Wiegand access control system. It combines AI video analytics with access control to provide a new level of convenience and security.

Models

Model	GV-FR Panel-5	GV-FR Panel-10
Event Log	50,000	100,000

1.1 Key Features

- Liveness detection (face spoofing detection)
- Live streaming on GV-VMS (coming soon)
- Mask Detection
- Masked Face Recognition
- Three access modes: Face Only mode, Card or Face mode, Card + Face mode
- Scanning QR code of for visitor access issued by GV-ASManager's visitor management system
- Scanning QR code of the EU Digital COVID Certificate
- Integration with GeoVision access controllers and software
- Integration with third-party Wiegand controllers
- Mobile app supported for push notifications
- 8" IPS touch screen with 800 x 1280 HD display
- Face recognition distance of up to 1 m (3 ft)
- Built-in RGB & IR cameras
- 10,000 face image capacity
- 10,000 access card capacity
- Built-in 13.56 MHz, ISO 14443A reader
- Built-in LED light for nighttime and low-light face recognition
- 16 languages supported (Bulgarian, Czech, English, French, German, Indonesian, Italian, Japanese, Portuguese, Russian, Slovak, Spanish, Simplified Chinese, Thai, Traditional Chinese, Ukrainian)
- CE, FCC, LVD, RoHS compliant

1.2 Packing List

1. GV-FR Panel



2. Wall Mount Bracket kit



For GV-Mount800 For GV-Mount801

3. Wiegand cable

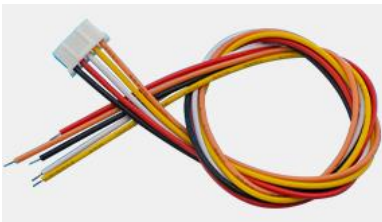

4. USB Host PH2.0-4P cable



5. RJ-45 cable



6. USB OTG PH2.0-4P cable



7. Power cable



1.3 Options

You can order the following optional accessories:

<u>GV-AS ID Card / Key Fob & GV-UHF Tag</u>	125 KHz and 13.56 MHz cards / key fobs, 900 MHz UHF Tag are available.
<u>GV-FWC</u>	GV-FWC integrates GeoVision face-recognition-based cameras, software and readers into access control systems by sending access card data, paired to Face IDs, to controllers either through TCP/IP or Wiegand.
GV-Mount800	With GV-Mount800, GV-FR Panel can be mounted standing up on a surface, such as a counter or desk.
GV-Mount801	With GV-Mount801, GV-FR Panel can be conveniently installed at any location aboveground.
GV-Mount920	With GV-Moun920, GV-FR Panel can be mounted on a surface, power box, or VESA mount.
Power Adapter	Contact our sales representatives for the countries and areas supported.

1.4 Firmware and Software Compatibility

GV-FR Panel is compatible with the following firmware and software versions:

Supported Product / Application		Version
Controller	GV-AS210 / 2110 / 2120	V2.31 or later
	GV-AS410 / 4110 / 4111	
	GV-AS810 / 8110 / 8111	
	GV-AS1520	V2.06 or later
	GV-AS1620	V1.03 or later
	GV-CS1320	V3.05 or later
	GV-EV48	V2.31 or later
GV-FWC access data converter		V1.02 or later
GV-ASManager access control software		V5.3.1 or later
GV-VMS		V17.5.0 / V18.4.0 or later
GV-Edge Recording Manager		V2.2.0 or later
Face Enrollment		GV-ASManager (software) V5.3.1 or later, GV-Face Manager (utility) V1.3.0 or later GV-Face (mobile app) V2.1.0 or later
Firmware Upgrade		GV-IP Device Utility V8.9.3 or later

1.5 Overview

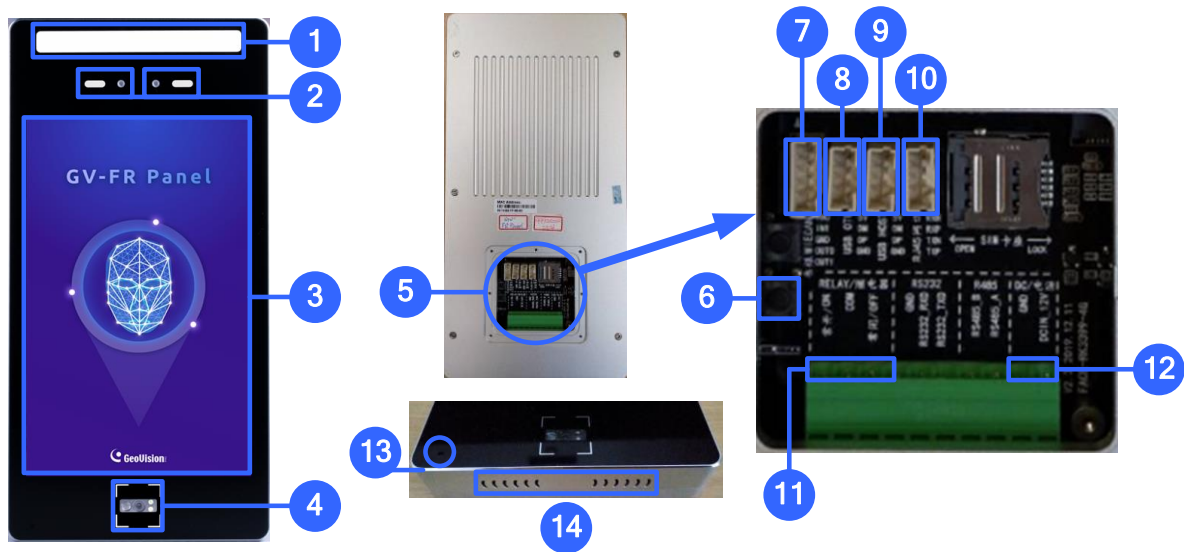

No.	Name	Function
1	LED Light	<ul style="list-style-type: none"> White LED: Turns on LED lighting when its radar sensor detects motion. Green LED: Turns on when recognizing registered faces. Red LED Turns on when detecting unknown faces.
2	Built-in Cameras	Captures real-time live images at the front of the panel.
3	Touchscreen Panel	Displays the live images captured by the built-in cameras and accesses its local settings.
4	QR Code Reader	Reads QR codes used for access control. The QR code LED turns on when detecting motion around.
5	Rear Panel	Contains all the ports of the GV-FR Panel, see No. 6 – 10.
6	Reset Button	Restarts the GV-FR Panel.
7	Wiegand Port	Connects to 3 rd -party controllers. See <i>Chapter 7 Third-Party Controller Integration</i> .
8	USB OTG PH2.0-4P Port	Connects to a PC for data backup and/or firmware upgrade via the supplied USB OTG PH2.0-4P cable (currently non-functional).
9	USB Host PH2.0-4P Port	Connects to a USB keyboard or mouse via the supplied USB Host PH2.0-4P cable.
10	RJ-45 Port	Connects to the network via the supplied RJ-45 cable.
11	Relay Output	Contains the following 3 relay pins: NO, COM and NC.
12	2-Pin Power connector	Connects to power via the supplied 2-pin power cable and an optional power adapter.

13	Microphone	Receives audio (enabled by default).
14	Speaker	Sounds when typing the settings on the touchscreen, swiping a card and scanning the QR code.
<p>Note: The SIM card slot, RS-485 and RS-232 ports are not functional.</p>		

1.6 Connecting GV-FR Panel

Follow the steps below to connect GV-FR Panel.

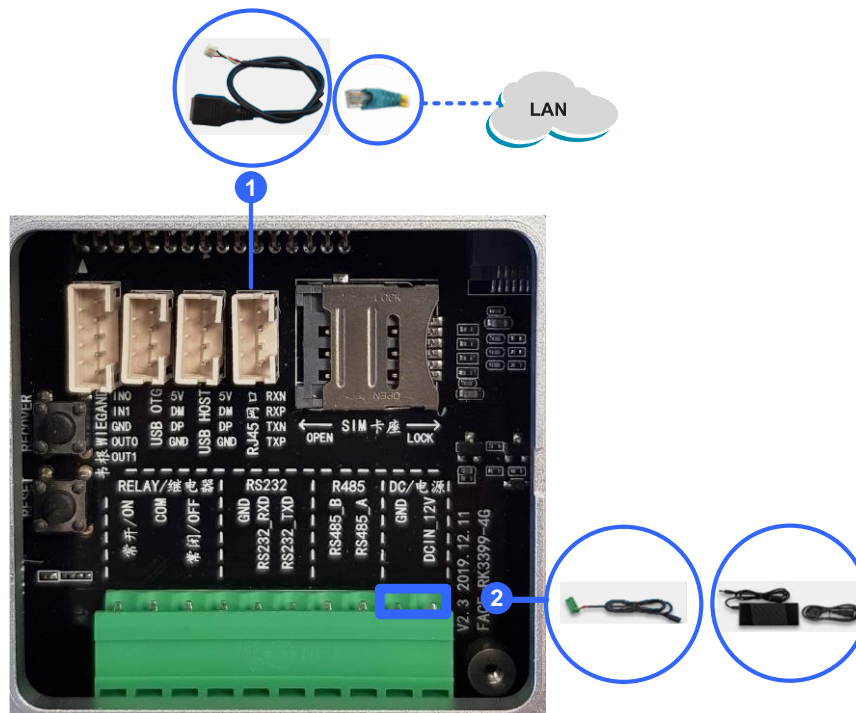

1. Connect the GV-FR Panel to the network using the supplied RJ-45 cable with a user-supplied Ethernet cable.
2. Connect the GV-FR Panel to power using the supplied 2-pin power cable and an optional power adapter.

Note: When unplugging a connected cable (No. 3 / 4 / 5 / 6 / 7, 1.2 Packing List) from GV-FR Panel for any reason, grip firmly onto the terminal block and pull out slowly. Do not pull the cable by the cord.

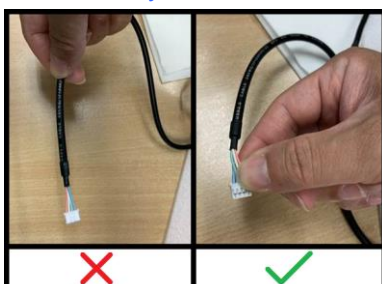

Upon first-time starting GV-FR Panel, users are prompted to set the login password for its Administrator account. After the password is set, the live view of the GV-FR Panel's built-in camera appears. For details, see *Chapter 2 Getting Started*.

1.7 Standard Installation

For installing GV-FR Panel on a wall, follow the steps below.

1. Place the mounting bracket on the wall and mark the locations of the 4 screw positions as illustrated below.

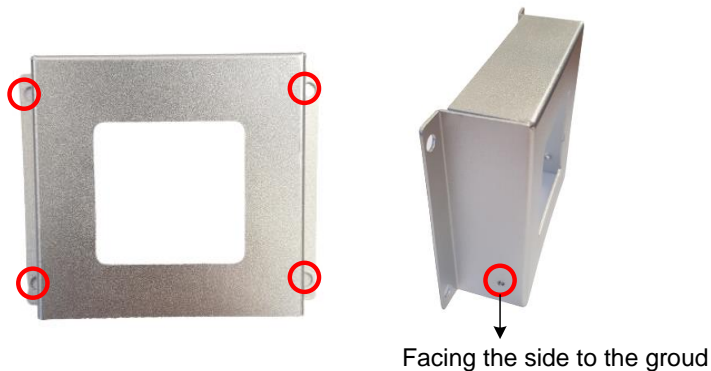

2. At each of the 4 screw positions marked on the wall, drill a hole slightly smaller than the plastic screw anchors provided.
3. Insert the 4 plastic screw anchors into the holes drilled and secure the mounting bracket onto the wall with the screws provided.
4. Secure the large sealing rubber and the back cover onto the back of the GV-FR Panel with the screws provided.

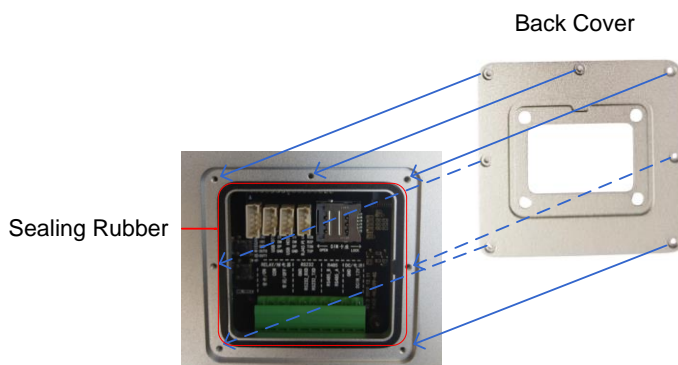

Note: Thread the necessary cables through the back cover and connect them to the panel before securing the cover.

5. Secure the small sealing rubber and the mounting plate onto the GV-FR Panel with the screws provided.

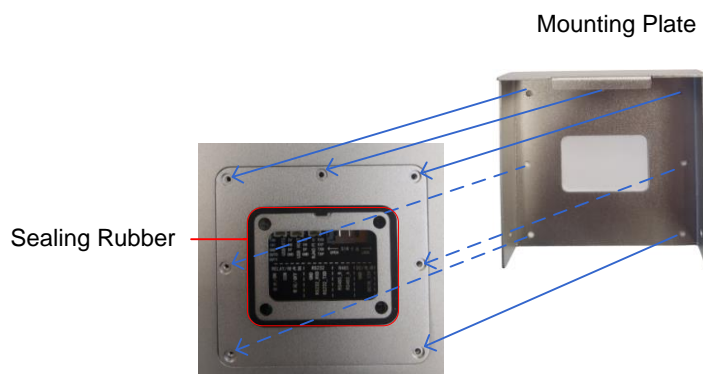

6. Secure the GV-FR Panel onto the wall by attaching its mounting plate onto the wall mount bracket.

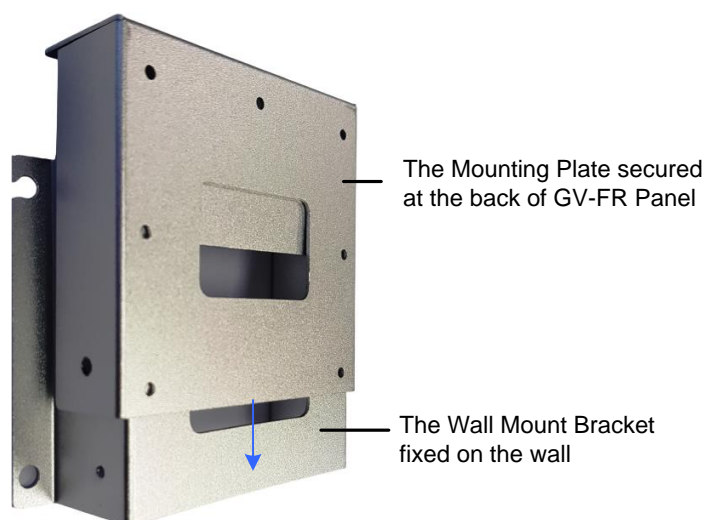

7. Insert a screw onto each side of the wall mount to secure and complete the installation.



Chapter 2 Getting Started

This chapter guides first-time users in accessing the GV-FR Panel and checking the IP address of GV-FR Panel in order to access it through a Web browser, as well all describing its local settings.

2.1 Accessing GV-FR Panel

Upon first-time starting GV-FR Panel, users are prompted to set the login password for its Administrator account. After setting the password, the live view of the GV-FR Panel's built-in camera appears.

After faces are registered in and recognized by the GV-FR Panel, a confirmation screen will be displayed and overlaid on the live image.

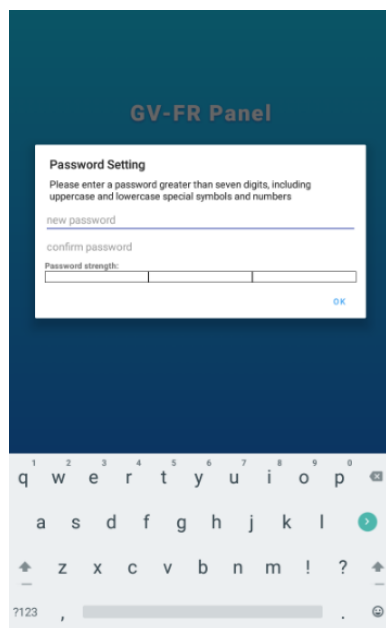

There are several methods to register faces:

1. **From the Web interface of GV-FR Panel.** See how to find the IP address of GV-FR Panel below in the manual, and select Face Management > Face Profiles on the Web interface.
2. **From the GV-ASManager access control system.** See *Chapter 4 User Management on GV-ASManager and GV-FR Panel.*
3. **Using the GV-Face Manager utility.** See *6.3 GV-Face Manager for Face Database Management.*

2.2 Looking Up the IP address

By default, GV-FR Panel is assigned with an unused IP address by the DHCP server when it is connected to a network. This IP address remains unchanged unless you unplug or disconnect your reader from the network.

Follow the steps below to check the IP address of your GV-FR Panel:

1. On the main screen of GV-FR Panel, tap the **GeoVision logo** at the upper-left corner of the touchscreen. You're prompted to type the password of its Administrator account.

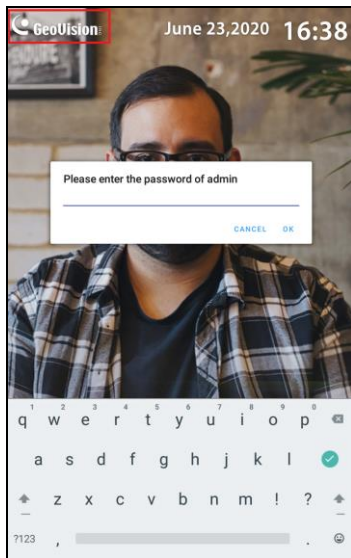

2. On the settings page, find the **IP Address** and **Web Port** of the GV-FR Panel,

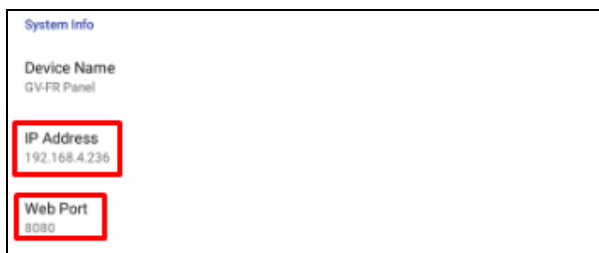

3. On a PC, open a Web browser and type the IP address and web port of the GV-FR Panel as exemplified below, e.g. 192.168.4.236:8080. The login page appears.

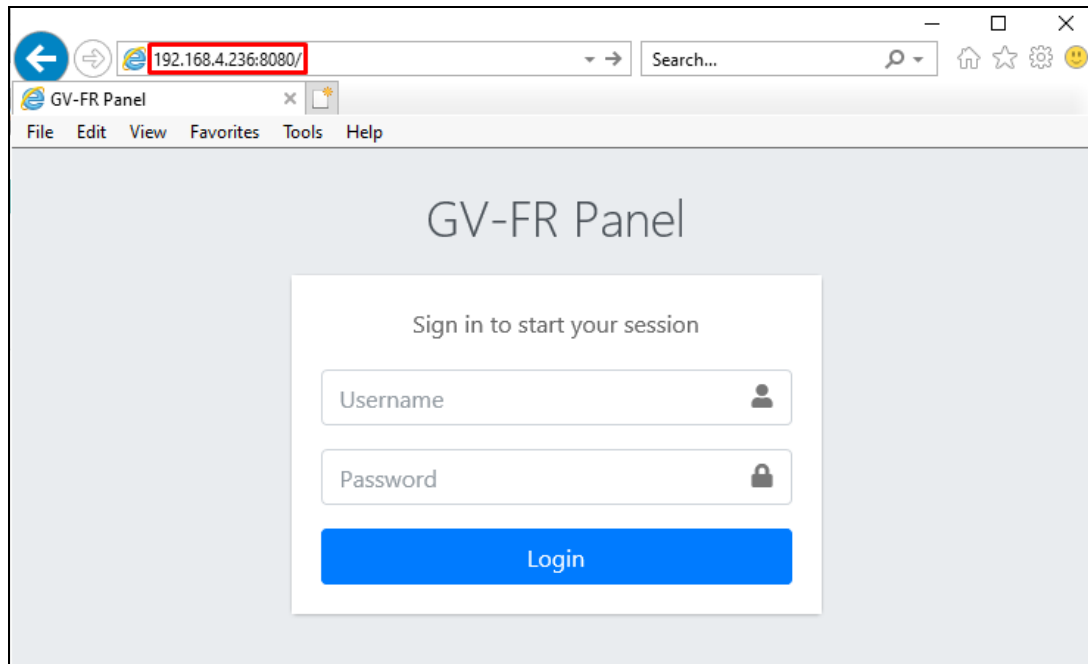

IMPORTANT: For accessing GV-FR Panel, it is required to add a colon and the port number (default port: 8080) after the IP address, e.g. <http://192.168.4.236:8080>.

4. Type *admin* for the username and the Administrator password of the GV-FR Panel to log in.

For the detailed settings available on the Web interface of GV-FR Panel, see *Chapter 5 Administrator Mode*.

Note:

1. You can only change the IP address directly on GV-FR Panel. To assign a static IP address to GV-FR Panel, use the local settings on the device. See *2.3 Local Settings*.
 2. You can also use GV-IP Device Utility to search for the IP address of GV-FR Panel. See *6.1 Upgrading System Firmware*.
-

2.3 Local Settings

To access the GV-FR Panel's local settings, tap the **GeoVision logo** at the upper-left corner of the touchscreen panel and type the login password that you've set. The following settings page appears.

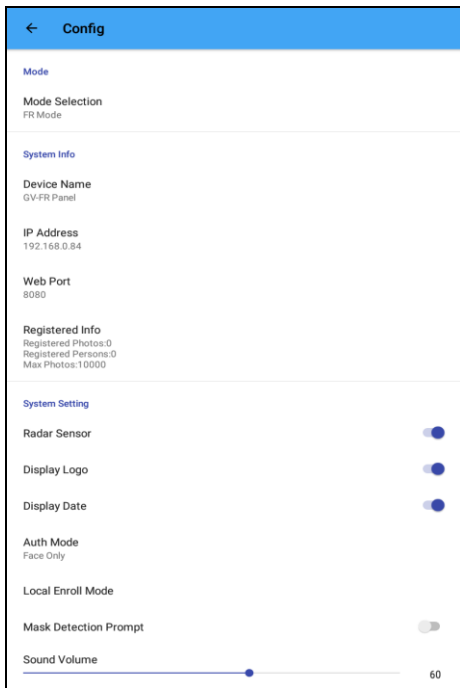

[FR Model-1]

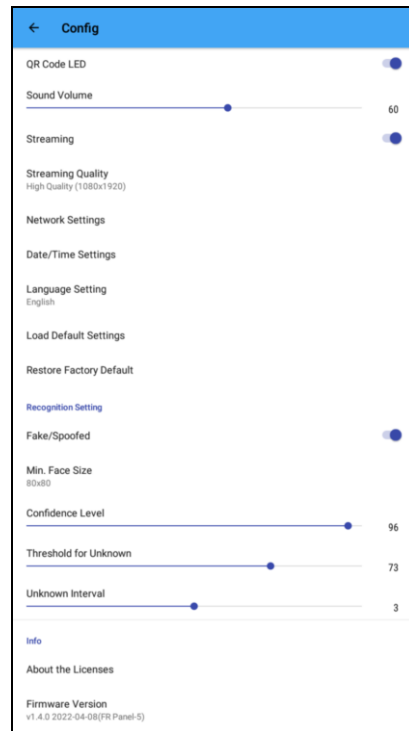

[FR Model-2]

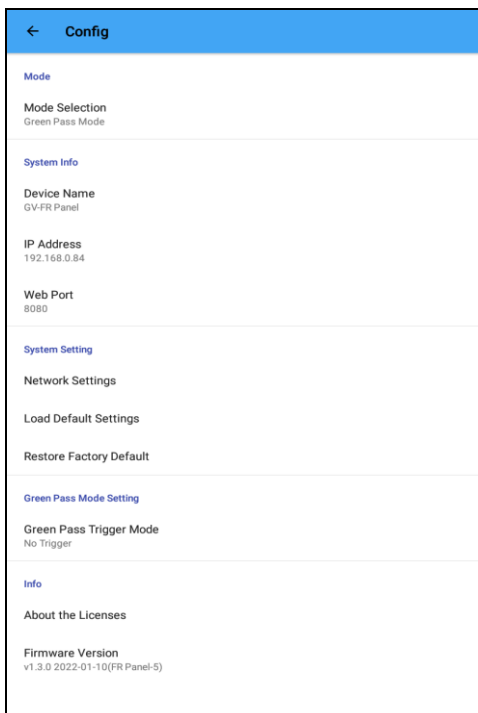

[Green Pass Mode]

[Model Selection]

Select **FR Mode** to grant access by face recognition, or **Green Pass Mode** to grant access by scanning QR codes of the EU Digital COVID Certificate.

Note: For the first time to use **Green Pass Mode**, it is required to connect GV-FR Panel to the Internet for accessing the database of the EU Digital COVID Certificate.

[System Info]

- **Device Name:** Displays the name of the device. To change the device name from the device's Web interface, see *5.1.1 System Settings*.
- **Network Settings / Web Port:** Displays the IP address and web port value of the device. To change the IP address, see **Ethernet Setting** below.
- **Registered Info:** Displays the number of users and face photos currently registered.

[System Settings]

- **Radar Sensor:** Enables radar sensor for detecting motion and automatically turning on the device's white LED.
- **Display Logo:** Enable to display the GeoVision logo on the touchscreen panel.
- **Display Date:** Enable to display the time and date at the upper-right corner of the touchscreen panel.
- **Auth Mode:** Select to authenticate and grant user access by *Face Only* mode, *Card or Face* mode, or *Card + Face* mode. **Face Only** mode is enabled by default.
- **Display NFC Detection Area:** Only when *Card or Face* is selected for Auth Mode, disable to remove the NFC detection area on the touchscreen panel.

Note: The *Card or Face* mode also supports reading the QR code of visitor access issued by GV-VMWeb. See *Chapter 12 GV-VMWeb for Visitor Management* in *GV-ASManager User's Manual*.

- **Local Enroll Mode:** Select to enroll faces directly using GV-FR Panel.
- **Mask Detection Prompt:** Disabled by default, swipe to enable **Voice Alert for Mask** and **Display Mask Info**.
 - **Voice Alert for Mask:** Enabled by Mask Detection Prompt, plays "Please wear a face mask" when a face without a mask is presented.
 - **Display Mask Info:** Enabled by Mask Detection Prompt, displays "Please wear a face mask" when a face without a mask is presented.

- **QR Code LED:** Enabled by default, QR Code LED turns on when detecting motion around. The option is available only when the Auth Mode is set to *Card* or *Face* mode.
- **Sound Volume:** Adjusts the sound volume of the device.
- **Streaming:** Disabled by default. Swipe to allow the connection on GV-VMS.
- **Streaming Quality:** Adjust the live streaming resolution, including **High Quality**, **Medium Quality**, and **Low Quality**.
- **Network Settings:** Enable DHCP or assign a static IP address.
- **Date & Time Settings:** Adjusts the date and time settings of the device.
- **Language:** Change the language of GV-FR Panel, from English as default, to Bulgarian, Czech, English, French, German, Indonesian, Italian, Japanese, Portuguese, Russian, Slovak, Spanish, Simplified Chinese, Thai, Traditional Chinese, Ukrainian
- **Load Default Settings:** Loads the default settings of the device.
- **Restore Factory Default:** Loads the default settings of the device while clearing all data registered.

IMPORTANT: The **Restore Factory Default** erases all your registered face profiles and event logs from GV-FR Panel.

[Recognition Settings]

- **Fake / Spoofed:** Enable to detect if the face is presented and displayed on a digital device.

Note: In terms of anti-spoofing applications, liveness detection isn't applicable to all situations 100% of the time. For a higher level of security, the integration with GV-ASManager for double-authentication, access card + face recognition, is strongly suggested.

- **Min. Face Size:** Select the minimum face size in pixels, for performing face recognition, which includes 80 x 80, 100 x 100, 120 x 120, 140 x 140, and 160 x 160. The default value is 80 x 80. Refer to the [technical notice](#) for how to set the min. face size.
- **Confidence Level:** Adjusts the confidence level for face recognition. The higher the level, the more definitive and stricter the device is toward distinguishing between similar faces. The default value is 80.
- **Threshold for Unknown:** Adjusts the unknown threshold for face recognition. Face recognition events below this confidence value are recorded as unknown. The default value is 73.

- **Unknown Interval:** The amount of time in seconds before face recognition can be performed again on recognition targets that have been identified as unknown.
- **Info:** Displays the firmware and server versions of the GV-FR Panel.

Chapter 3 Access Control Integration

This chapter explains how to set up the connections among GV-FR Panel, GV-AS Controller and GV-ASManager software.

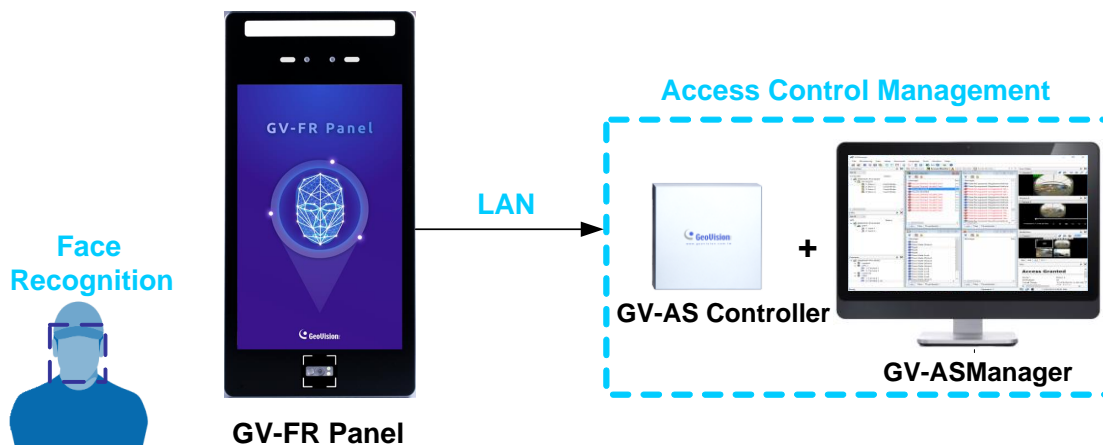

Users need to complete all the configurations in Chapter 3 to connect GV-FR Panel to GV-AS Controller and GV-ASManager software:

Integrate with GV-ASManager

Add GV-AS Controller and GV-FR Panel to GV-ASManager

3.1.1 Adding GV-AS Controller

3.1.2 Setting GV-FR Panel to be a Door



User Management on GV-ASManager and GV-FR Panel

Once the three -- GV-FR Panel, GV-ASController and GV-ASManager -- are connected, enroll user faces on GV-ASManager. See *Chapter 4*.

Note: Make sure your GV-AS Controller and GV-ASManager support connecting to GV-FR Panel via network. See *Firmware and Software Compatibility* at the beginning of the manual.

3.1 Setting up GV-ASManager

Integration with GV-ASManager allows you to utilize full access control functions. This section covers the basic settings for connecting GV-Controller and GV-FR Panel to GV-ASManager.

For more details on GV-ASManager functions, see *GV-ASManager User's Manual*.

3.1.1 Adding GV-Controller

To connect GV-FR Panel and GV-AS Controller to GV-ASManager, you need to first connect GV-AS Controller to GV-ASManager. To do so, follow the steps below.

1. On the menu bar of GV-ASManager, click **Setup** and select **Devices**. The Device List dialog box appears.

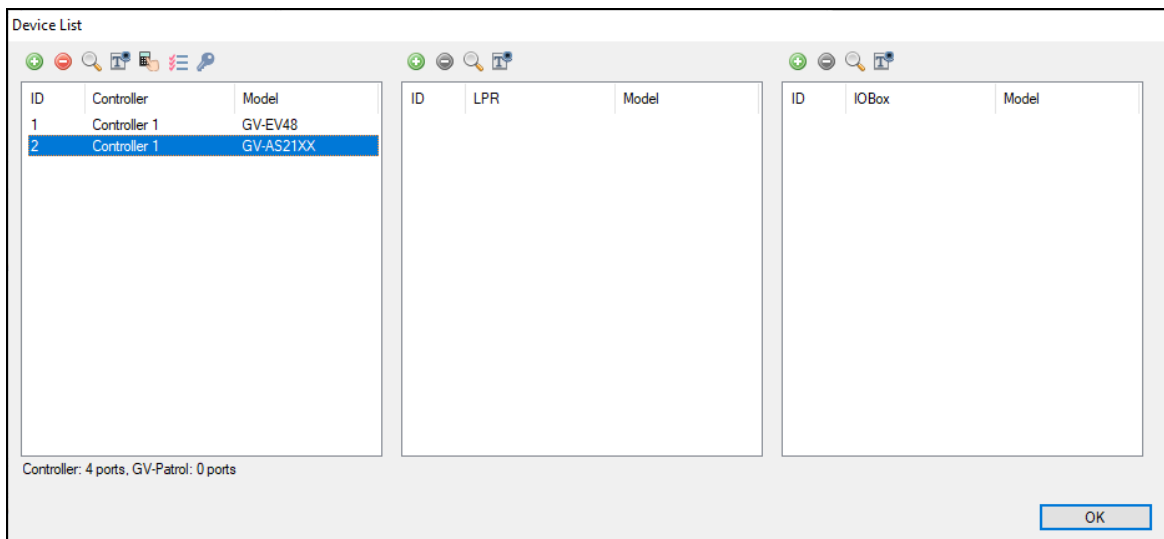

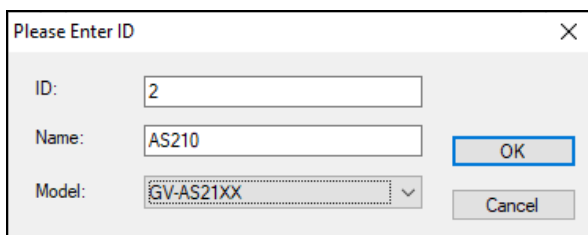

2. Click the **Add** icon  on the top left corner. This dialog box appears.

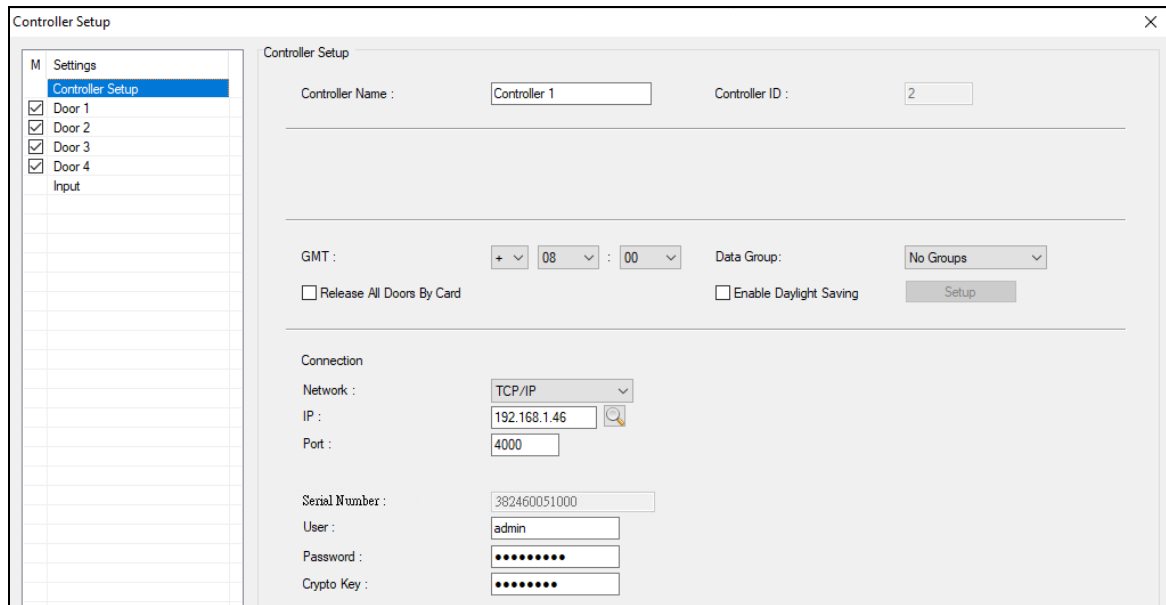

- Specify the **ID**, **Name** and **Model** of the controller to be connected and click **OK**. This dialog box appears.

Note: The ID must match with that set up on the controller (Advance Setting > Function Configuration).



- In the **Network** dropdown list, select **TCP/IP** as the communication mode between the controller and GV-ASManager.
- Type the **IP address**, **port number**, **login user**, **password** and **Crypto key** (3DES code) of the controller. You can also click the **Search** button  to search for controllers within the same LAN.

Note: By default, GV-AS Controller has a port value of **4000**.

- To check if connection settings are correct, click **OK**, and a  icon should appear in the Device View window indicating successful connection between the controller and GV-ASManager.

3.1.2 Setting GV-FR Panel to be a Door

Once GV-AS Controller has been connected to GV-ASManager, you then need to connect GV-FR Panel to GV-AS Controller. To do so, follow the steps below.

Note: The following procedures are only applied to GV-FR Panel V1.2.0 or later.

1. On the menu bar of GV-ASManager, click **Setup** and select **Devices**.
2. Double-click the controller that GV-FR Panel to be connected to and select a **Door**. This dialog box appears.

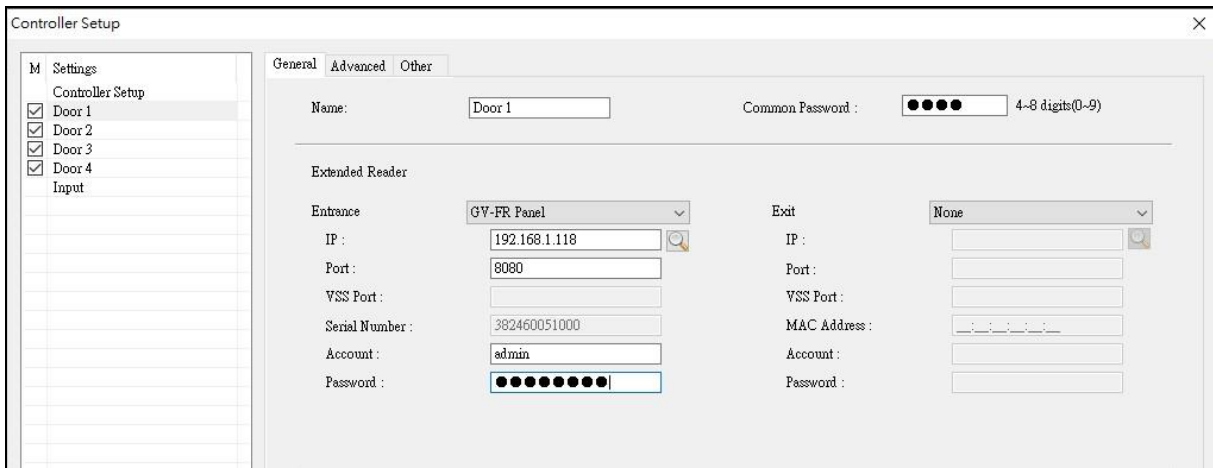

3. Select **GV-FR Panel** from the **Entrance** and/or **Ext** dropdown list, in accordance to your installation site.
4. Type the **IP address**, **Port number**, **Account ID** and **Password** of the GV-FR Panel.
5. Click **OK**. The GV-FR Panel is connected to the controller and GV-ASManager is also connected with GV-FR Panel.

To verify the connection on **GV-FR Panel**:

6. On the GV-FWC / Controller Setting page (**Notify Settings > GV-FWC/Controller**), you should find an entry, for example, *[ASManager] Door 4-FR (In)*, written back from GV-ASManager to indicate which controller IP and which door is connected to.

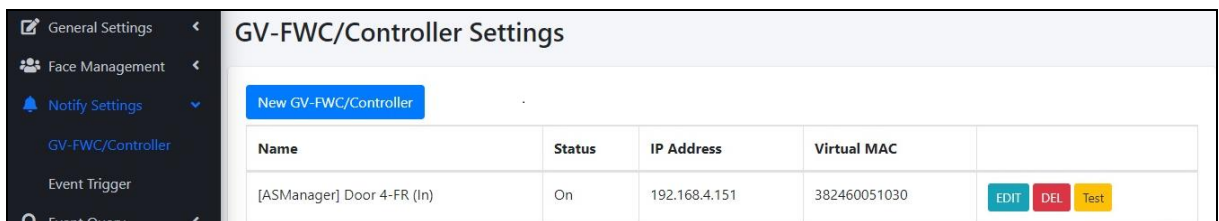

- On the Event Trigger page (**Notify Settings > Event Trigger**), you should also find two entries of “Trigger to ASM”. No matter which condition, registered or unknown faces / cards, all will trigger GV-FR Panel to send the access data to GV-ASManager.

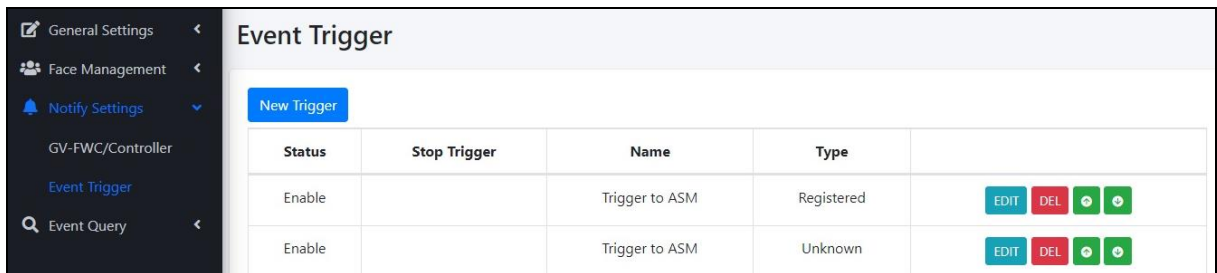

You can also perform the test to remotely enroll a face to GV-ASManager:

- Show a face in front of the GV-FR Panel. The **Access Denied Invalid Card** message will appear on GV-ASManager.
- Right-click the message and select **Assign Image to a New User** to create a user account in the GV-ASManager.

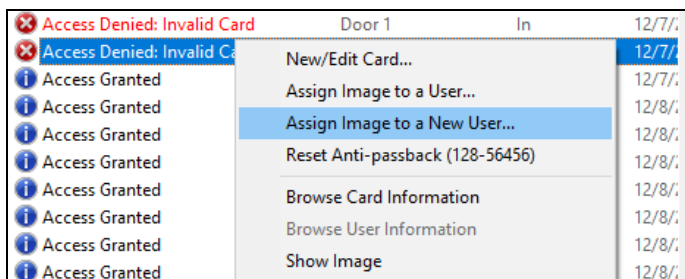

If the test fails, you may need to check the connection between GV-FR Panel and the controller, see *Appendix A*.

Note:

- By default, GV-FR Panel is set to face recognition only. To apply *Card or Face mode* or *Card + Face mode*, go to the local settings of GV-FR Panel. See *2.3 Local Settings*.
- For details on other settings under the Door tab, see *4.2.2 Step 2: Configuring the Doors or Elevator Floors* in *GV-ASManager User's Manual*.

Chapter 4 User Management on GV-ASManager and GV-FR Panel

Once you have set up the connections among GV-FR Panel, GV-AS Controller and GV-ASManager software, you can begin to create and manage users on GV-ASManager and GV-FR Panel.

Setup Prerequisite:

Before enrolling face photos in GV-ASManager, you need to have completed the following settings on GV-ASManager:

- Cards added
- Users added with Cards assigned

For details, see *4.3 Setting Cards* and *4.6 Setting Users* respectively in *GV-ASManager User's Manual*.

Follow the three steps below to enroll face photos in GV-ASManager and sync the user data to GV-FR Panel:

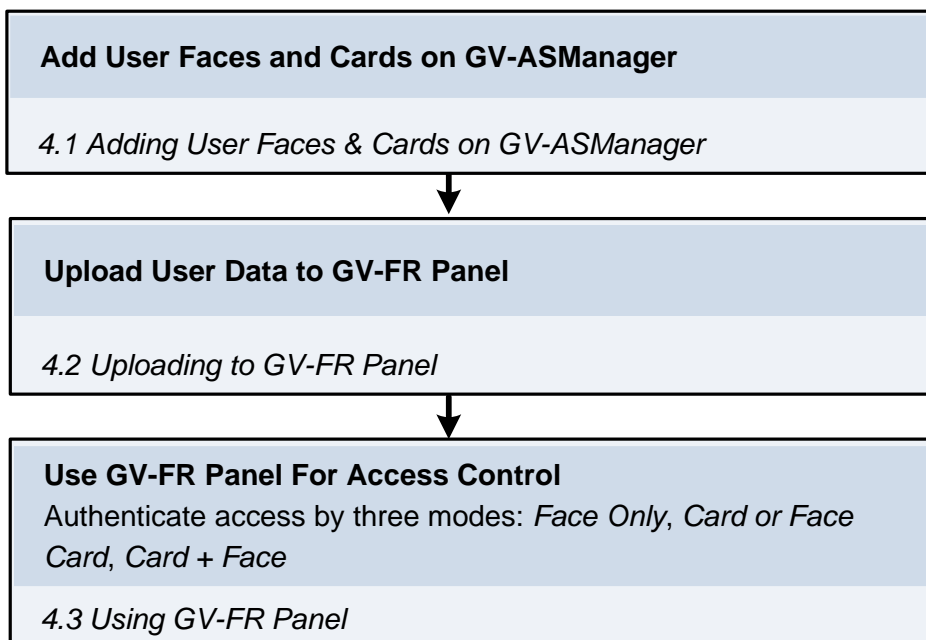

4 User Management on GV-ASManager & GV-FR Panel

4.1 Adding User Faces & Cards on GV-ASManager



To enroll faces images for the Users in GV-ASManager, follow the steps below.

1. On the menu bar of GV-ASManager, click **Personnel** and select **Users**. The User List window appears.
2. Double-click a User from the User List. The User Setup dialog box appears.
3. Select the **Features** tab.
4. Click on the image column under **GV-VD8700 / GV-FD8700-FR / GV-AI FR / GV-FR Panel**.

The screenshot shows the 'User Setup' dialog box with the 'Features' tab selected. The 'Features' tab is highlighted with a red box. The dialog box contains the following sections:

- Fingerprint:** Includes fields for 'IP Address', 'Port' (set to 2167), and a 'Search' button. There is also an 'Anti-duress' dropdown menu.
- Left hand:** Five finger selection dropdowns: Thumb, Forefinger, Middle finger, Ring finger, and Little finger.
- Right hand:** Five finger selection dropdowns: Thumb, Forefinger, Middle finger, Ring finger, and Little finger.
- GV-FR2020 Features:** Includes radio buttons for 'User' (selected) and 'Manager', and a dropdown menu.
- GV-VD8700 / GV-FD8700-FR / GV-AI FR / GV-FR Panel:** A dropdown menu, which is highlighted with a red box.

At the bottom of the dialog box, there are 'OK' and 'Cancel' buttons.

5. In the Image Selection window, use one of the following three options to add a face photo for the User. Up to 3 photos for one User can be added.
 - Click **Webcam Capture**  to take a face photo with a connected webcam camera.
 - Click **Add**  to browse for a face photo from the PC.
 - Click **Add from Logs**  to use a snapshot captured within the GV-ASManager's logs.

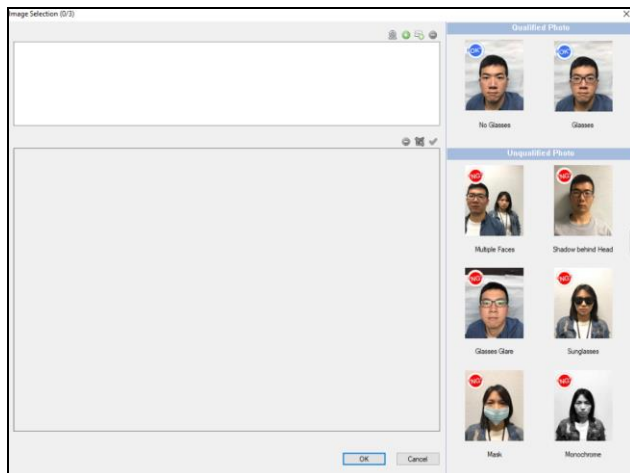

6. Optionally crop the face photo if needed. Click **OK**.
7. After the photo has been added, select an access card number for the User within the dropdown list next to the face photo. The paired access card number can be used in *Card or Face* mode or *Card + Face* mode when applicable.

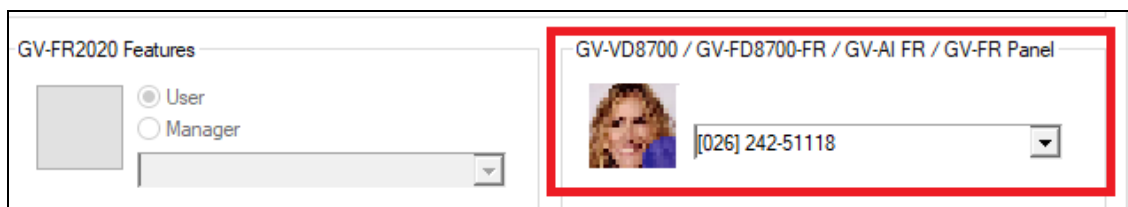

8. Click **OK** to apply the settings.

The face photo has now been added to the User and paired to the access card number selected for face-recognition-based access control.

4 User Management on GV-ASManager & GV-FR Panel

Note:

1. For FR-based access control to work, the same Users, along with their face photos and access card numbers, must also be uploaded to GV-FR Panel, see the following section, [4.2 Uploading to GV-FR Panel](#).
2. When uploading Users to GV-FR Panel, their **Display Names**, set up in the User Setup dialog box, will be the names of faces in the GV-FR Panel database.

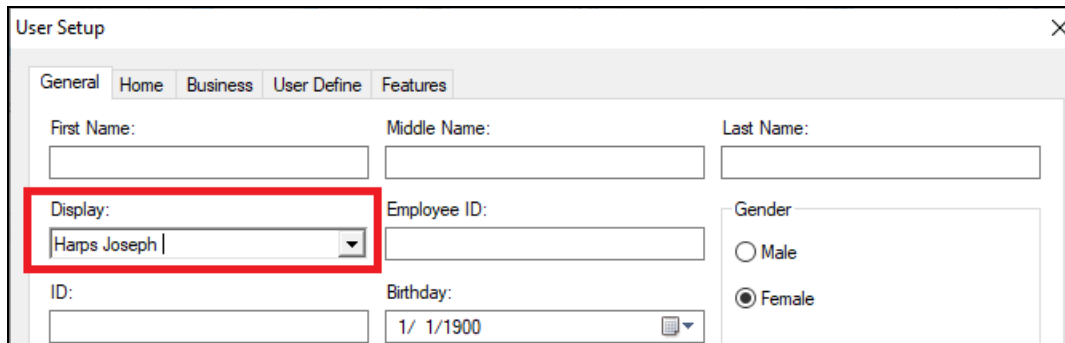

The screenshot shows the 'User Setup' dialog box with the following fields and options:

- General | Home | Business | User Define | Features
- First Name: [] Middle Name: [] Last Name: []
- Display:** [Harps Joseph] (highlighted with a red box)
- Employee ID: []
- Gender: Male Female
- ID: [] Birthday: 1/ 1/1900

4.2 Uploading to GV-FR Panel

To upload Users to GV-FR Panel, along with their face photos and access card numbers, follow the steps below.

1. On the menu bar of GV-ASManager, click **Setup** and select **Feature Access**. The Feature Access dialog box appears.
2. Select **GV-AI FR / GV-FR Panel** from the **Feature Type**. From the left column, select the corresponding **Door** to which the GV-FR Panel is connected.
3. Select the desired User from the right column. The **Add** button becomes available.

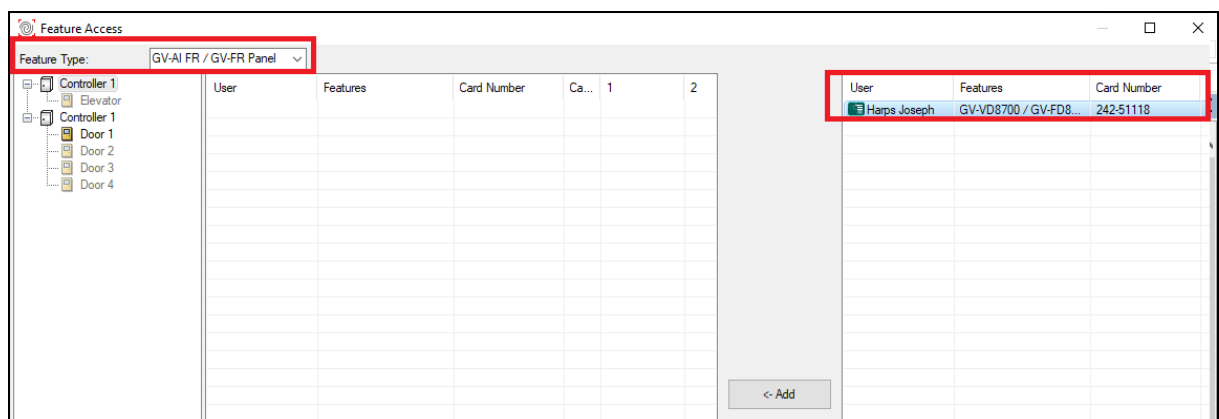



The screenshot shows the 'Feature Access' dialog box with the following elements:

- Feature Type: GV-AI FR / GV-FR Panel (highlighted with a red box)
- Left column: Controller 1, Elevator, Controller 1, Door 1, Door 2, Door 3, Door 4
- Table with columns: User, Features, Card Number, Ca... 1, 2
- Table content (highlighted with a red box):

User	Features	Card Number
Harps Joseph	GV-VD8700 / GV-FD8...	242-51118
- Bottom right: <- Add button

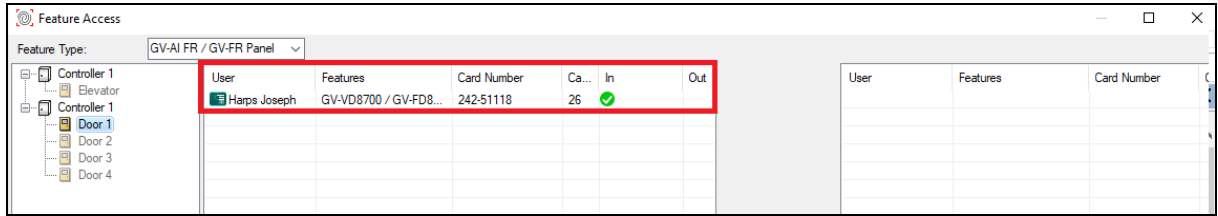
- Click the **Add** button to add the User to the selected Door. The resulting window after adding may look like this, with a green tick  indicating that the User has been successfully uploaded to the GV-FR Panel..



- Click the 'x' icon  to close the Feature Access window.

Note:

- Each GV-FR Panel can store up to 10,000 face photos.
- The face photos uploaded will be saved on both the GV-FR Panel and GV-ASManager.

IMPORTANT: The **Sync GV-AI FR / GV-FR Panel** function on GV-ASManager replaces the current face database of GV-FR Panel, erasing all event logs on it.

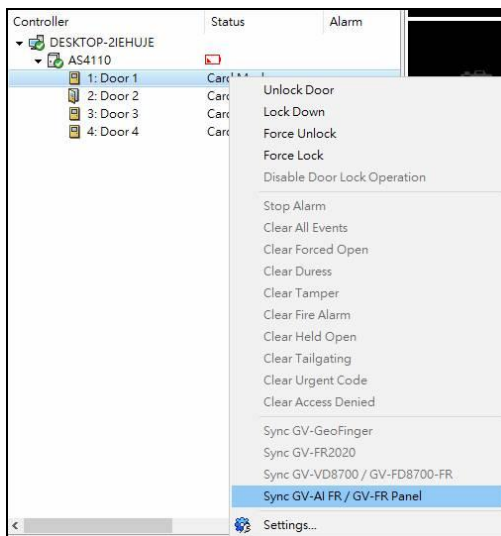

4.3 Using GV-FR Panel

After uploading the user data from GV-ASManager to GV-FR Panel, you can start managing its access control by one of the following three authentication modes: *Face Only*, *Card or Face* and *Card + Face*.

4.3.1 Face Only Mode

In the default mode of face recognition only, when the presented face matches any registered user faces, a confirmation screen will appear on the GV-FR Panel with an access signal being passed to the controller.



On GV-ASManager, a message “Access Granted” will be displayed. When you click the message, its associated photo enrolled and the live image captured onsite will be available.

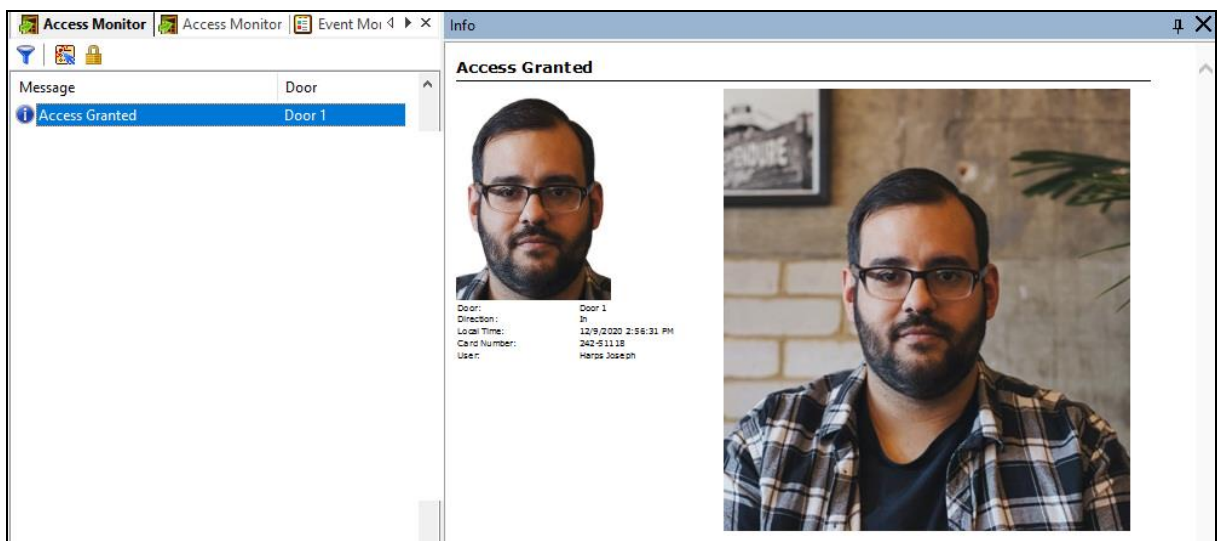

4.3.2 Card or Face Mode

The Card or Face mode allows users to gain access with either a paired card or face recognition. To manage access by face recognition or card swipe, make sure **Card or Face** is selected as the GV-FR Panel's authentication mode, see *2.3 Local Settings*

4.3.3 Card + Face Mode

The Card + Face mode only allows users to gain access when both the user's card and face have been authenticated. To manage access by card swipe and face recognition, make sure **Card and Face** is selected as the GV-FR Panel's authentication mode, see *2.3 Local Settings*.

In order to be granted access, the personnel accessing must first swipe a paired card and then perform face recognition on the GV-FR Panel. Once both have been authenticated, a confirmation screen will appear with an access signal being passed to the controller. If the face presented cannot be recognized by the GV-FR Panel, within 7 seconds, the access will be denied.

Chapter 5 Administrator Mode

The Administrator can access and configure all the settings of the GV-FR Panel over the network. The configuration categories include: **General Settings**, **Face Management**, **Notify Settings** and **Event Query**.

Corresponding Section for Configuration Menu

Find the topic of interest by referring to the sections below.

5.1 General Settings	5.1.1 System Settings 5.1.2 Account & Authority 5.1.3 Recognition Settings 5.1.4 Relay Settings
5.2 Face Management	5.2.1 Face Profiles
5.3 Notify Settings	5.3.1 GV-FWC/Controller 5.3.2 Event Trigger
5.4 Event Query	5.4.1 Detail Log

5.1 General Settings

5.1.1 System Settings

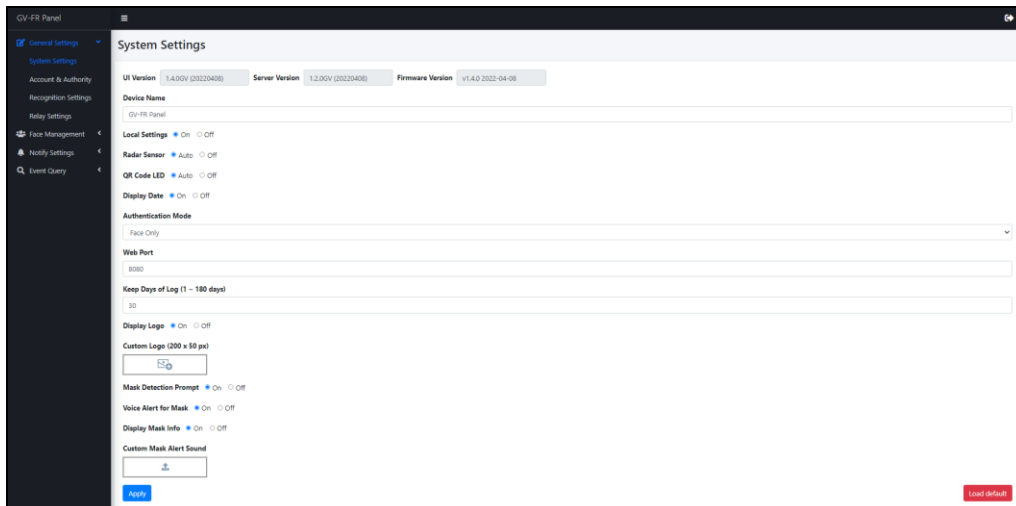

- **Device Name:** Type a desired name for the GV-FR Panel.
- **Local Setting:** Enable the accessibility of the local settings. For details, see *2.3 Local Settings*.
- **Radar Sensor:** Enable radar sensor for detecting motion and automatically turning on the device's white LED.
- **QR Code LED:** Enabled by default, the QR Code LED turns on when detecting motion around.
- **Display Date:** Enable to display the time and date at the upper-right corner of the touchscreen panel.
- **Authentication Mode:** Select to authenticate and grant user access by three modes: *Face Only*, *Card or Face*, *Card + Face*.
- **Web Port:** Optionally modify the default web port value of 8080.
- **Keep Days of Log (1 ~ 180 days):** Define the number of days the log data are kept for.
- **Display Logo:** Enable to display the GeoVision logo on the touchscreen panel.
- **Custom Logo (200 x 50 px):** Optionally browse for a desired logo, with a pixel size of 200 x 50, to be displayed at the upper-left corner of the GV-FR Panel, in place of the GeoVision logo.
- **Mask Detection Prompt:** Select **On** to enable the following two options:
 - **Voice Alert for Mask:** Play "Please wear a face mask" when a face without a mask is presented.
 - **Display Mask Info:** Display "Please wear a face mask" when a face without a mask is presented.
- **Custom Mask Alert Sound:** Optionally browse for a desired alert sound. Note that only mp3 files within 100 KB are applicable.
- **Load Default:** Loads the default settings of the device.

IMPORTANT: The **Clear Settings & Data** option under **Load Default** erases all your registered face profiles and event logs from GV-FR Panel.

5.1.2 Account & Authority

On the **Account & Authority** page, users can create additional Administrator and Guest accounts for accessing the GV-FR Panel.

Username	Role	
admin	Admin	EDIT DEL
guest	Guest	EDIT DEL

Showing 1 to 2 of 2 entries

5.1.3 Recognition Settings

Fake/Spoofed On Off

Min. Face Size(pixels)

80 x 80

Confidence Level:76

Threshold for Unknown:70

Unknown Interval

3 sec

Apply

- **Fake / Spoofed:** Enable to detect if the face is presented with inanimate objects, such as a printed photo.
- **Min. Face Size:** Select the minimum face size, in pixels, for performing face recognition.
- **Confidence Level:** Adjusts the confidence level for face recognition. The Higher the level, the more definitive and stricter the device is toward distinguishing between similar faces.
- **Threshold for Unknown:** Adjusts the unknown threshold for face recognition. Face recognition events below this confidence value are recorded as unknown.
- **Unknown Interval:** The amount of time in seconds before face recognition can be performed again on recognition targets that have been identified as unknown.

5.1.4 Relay Settings

You can set up an output device to be triggered as soon as registered faces are recognized.

Note: Make sure an output device is connected to the GV-FR Panel.

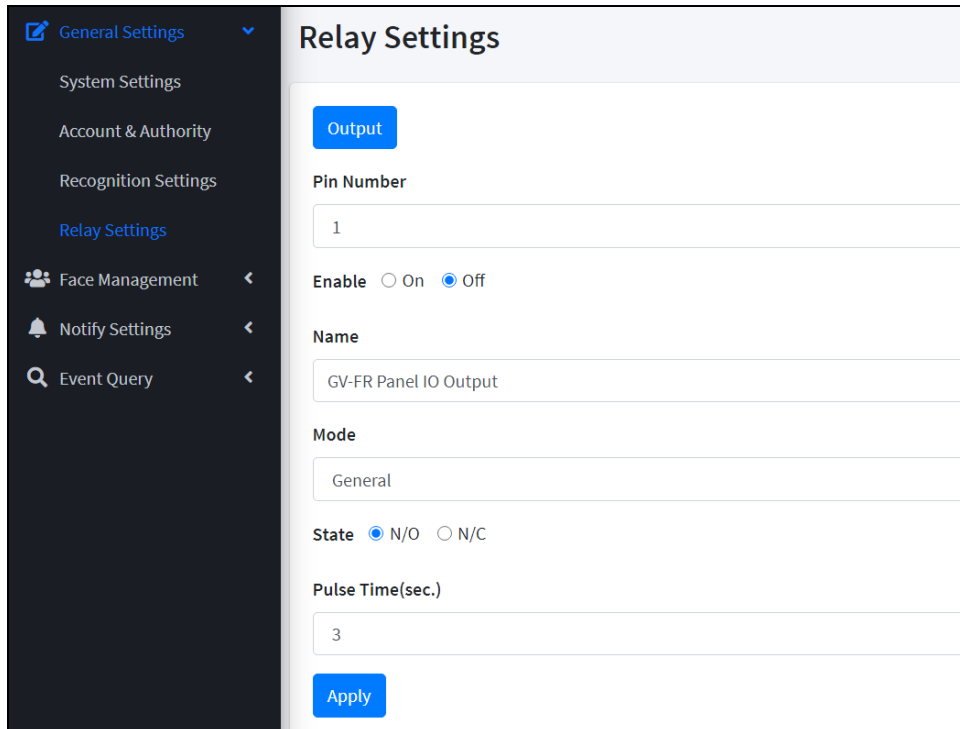

The screenshot shows the 'Relay Settings' configuration page. On the left is a dark sidebar with navigation options: General Settings (selected), System Settings, Account & Authority, Recognition Settings, Relay Settings, Face Management, Notify Settings, and Event Query. The main content area is titled 'Relay Settings' and contains the following fields:

- Output:** A blue button labeled 'Output'.
- Pin Number:** A text input field containing the value '1'.
- Enable:** Radio buttons for 'On' and 'Off', with 'Off' selected.
- Name:** A text input field containing 'GV-FR Panel IO Output'.
- Mode:** A dropdown menu currently set to 'General'.
- State:** Radio buttons for 'N/O' and 'N/C', with 'N/O' selected.
- Pulse Time(sec.):** A text input field containing the value '3'.
- Apply:** A blue button labeled 'Apply' at the bottom.

- **Output:** Force triggers the output connected.
- **Pin Number:** The GV-FR Panel only supports one output pin and device.
- **Name:** Type a desired named for the output device.
- **Mode:** Select an output trigger mode from one of the following:
 - **General:** Select to trigger the output only once.
 - **Toggle:** Select to always trigger the output.
 - **Pulse:** Select to trigger the output for the amount of time specified under *Pulse Time (s)*.
- **State:** Defines its non-triggered state as normally open or normally closed.

To trigger the configured output device upon face / card recognition events, select **Notify Settings > Event Trigger > New Trigger** and select **Relay Output** under Trigger Output. See 5.3.2 *Event Trigger*.

5.2 Face Management

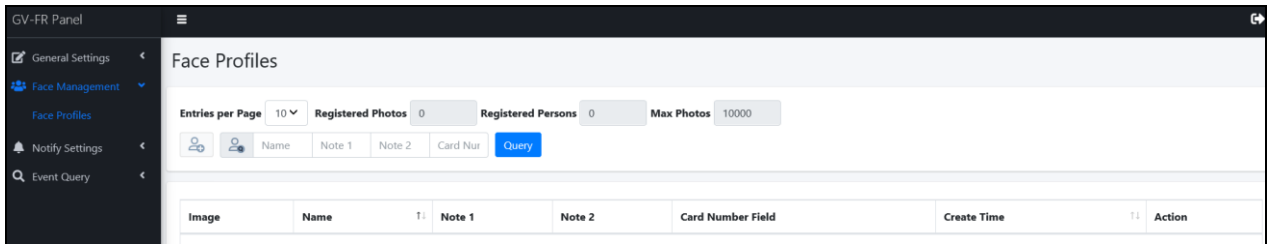

5.2.1 Face Profiles

On the **Face Profiles** page, users can enroll face photos used for access control by the GV-FR Panel.

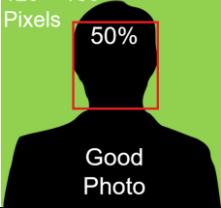

Note:

1. For having consistent user data between GV-FR Panel and GV-ASManager, you need to create user accounts and enroll face photos in GV-ASManager and then sync the data back to GV-FR Panel.
 - For integration with GeoVision controllers and software, see *Chapter 3 Access Control Integration*.
2. You can also use GV-Face Manager utility to create face profiles. See *6.3 GV-Face Manager for Face Database Management*.
3. Note the following requirements for the face enrollment:
 - Each photo must consist of only one face.
 - Size of the face within the photo should be within 120 ~ 150 pixels.
 - The file size of the photo cannot exceed 50 KB.
 - Only JPEG format is supported.
 - Make sure the face of the person does not occupy more than 50% of the image.

Ideal	Failed to enroll – 1	Failed to enroll – 2
 <p>Face size 120 ~ 150 Pixels</p> <p>50%</p> <p>Good Photo</p>	 <p>Face > 50%</p> <p>Failed Photo</p>	 <p>Face size < 120 pixels</p> <p>Failed Photo</p>
<p>The face occupies 50% of the image. The size of the person's face is between 120 ~150 pixels.</p>	<p>The face occupies more than 50% of the image.</p>	<p>The size of the person's face is less than 120 pixels.</p>

1. Click **New Face** . This window appears.

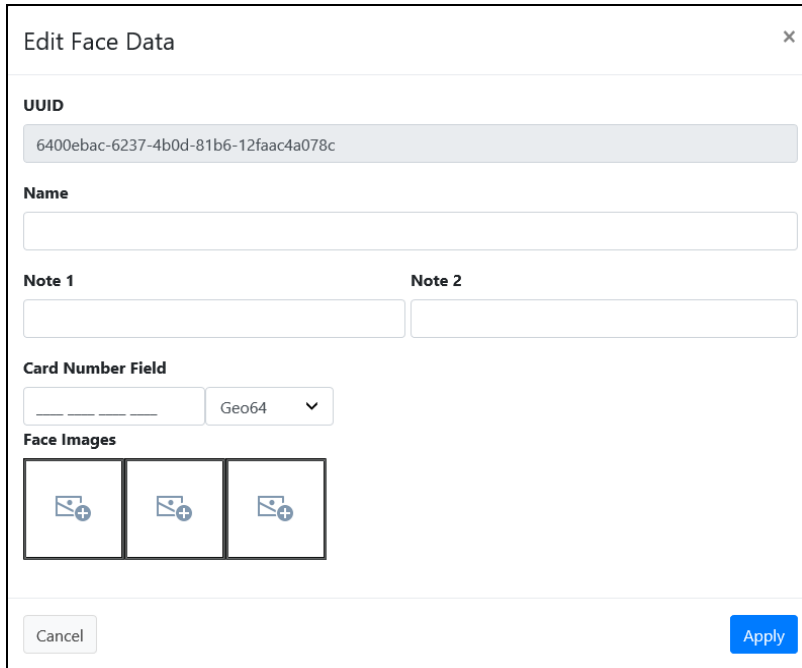

2. Type a desired name for the face profile under **Name**.
3. Optionally type notes for the face profile under **Note 1** and **Note 2**.
4. Type the number of the access card to be assigned to the face profile under **Card Number Field**. Select the corresponding card format from the dropdown list.
5. Click the icon under **Images** to browse for and add up to 3 face photos for the face profile.
6. Click **Apply**. The face profile is created.

IMPORTANT: When you delete a created face profile, its related event logs will also be erased.

5.3 Notify Settings

5.3.1 GV-FWC/Controller

The **GV-FWC/Controller** page allows users to check the connection information of the connected GV-AS Controller, or add a GV-FWC for third-party integration. To add a GV-FWC, see details in *7.2 Via GV-FWC Converter*.

1. On the Web interface of GV-FR Panel, select **Notify Settings > GV-FWC/Controller**.

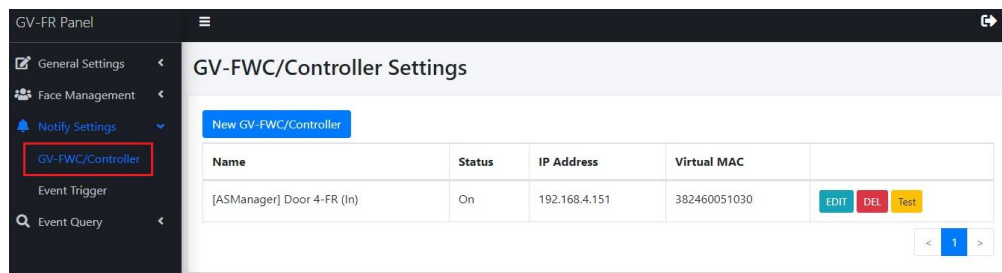

2. Click **EDIT** to change device name, IP address and enable/disable connection if necessary.

Edit GV-FWC/Controller ×

Name

Activation On Off

IP Address

Virtual MAC

3. Click **Apply**.

5.3.2 Event Trigger

The **Event Trigger** page allows users to set up various trigger actions upon face / card recognition events.

1. On the Web interface of GV-FR Panel, select **Notify Settings > Event Trigger**.

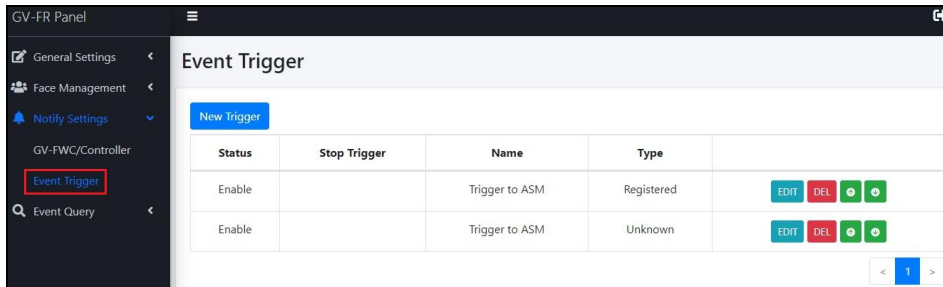

Note: Once GV-ASManager is connected to GV-FR Panel successfully, you will see two entries of “Trigger to ASM” automatically created on this page. No matter which condition, registered or unknown faces / cards, the access data will be sent to the GV-ASManager.

For example, if there is a corresponding user account for the face / card presented, the message “Access Granted” will appear on the GV-ASManager. If the face / card presented is not registered on the GV-ASManager, the message “Access Denied: Invalid Card” will be displayed, with an empty card number “000-00000”.

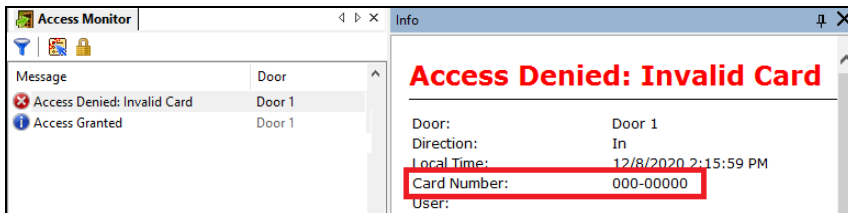

2. To set up a new trigger action, click **New Trigger**. To configure a trigger action, click **EDIT**.

This dialog box appears.

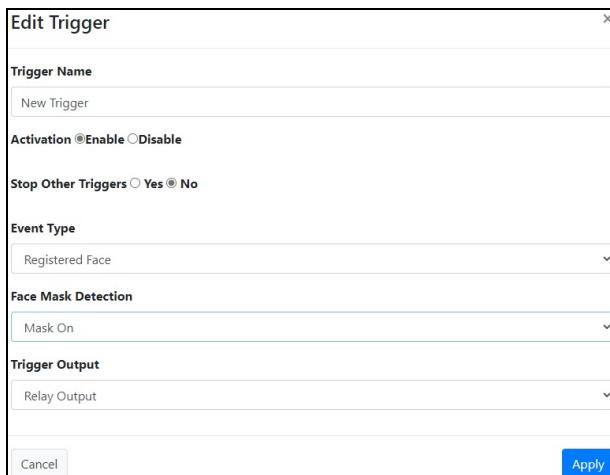

3. Name the trigger under **Trigger Name** and select **Enable** next to **Activation**.
4. Select the type of events the trigger action is triggered for under **Event Type**.
 - **Registered Face:** Triggers action when registered faces / cards from the database are recognized.
 - **Unknown Face:** Triggers action when unknown faces / cards are detected.
5. Under **Face Mask Detection**, select whether wearing a face mask or not will also trigger action.
6. Under **Trigger Output**, select a desired type of trigger action from *GV-FWC/Controller*, *GV-Face App*, *Relay Output* or *Wiegand Output*.
7. Click **Apply**.



Note: To trigger an output device upon face / card recognition events, see [5.1.4 Relay Settings](#).

5.4 Event Query

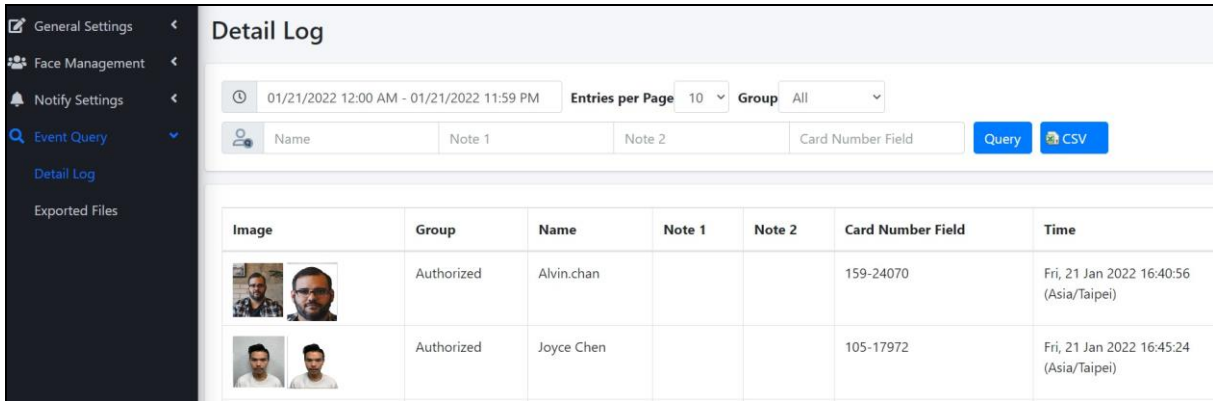
The **Event Query** allows users to search for events during a specified time. When accessing **Detail Log**, apply the desired search criteria and click **Query**.



The screenshot shows the 'Detail Log' interface. At the top, there are search filters: a date range from 01/21/2022 12:00 AM to 01/21/2022 11:59 PM, 'Entries per Page' set to 10, and 'Group' set to All. Below the filters are input fields for 'Name', 'Note 1', 'Note 2', and 'Card Number Field', along with 'Query' and 'CSV' buttons. The main area contains a table with the following data:

Image	Group	Name	Note 1	Note 2	Card Number Field	Time
	Authorized	Alvin.chan			159-24070	Fri, 21 Jan 2022 16:40:56 (Asia/Taipei)
	Authorized	Joyce Chen			105-17972	Fri, 21 Jan 2022 16:45:24 (Asia/Taipei)

The search results are displayed based on the criteria set, with the data explained below.

- **Image (Live/Enrolled):** Displays the face snapshot captured upon a face / card recognition event, along with the face image already enrolled for the Face Profile recognized.
- **Name / Note 1 / Note 2 / Card Number Field:** Displays the name, note 1, note 2 and the card number of the Face Profile recognized.
- **Time:** Displays the time of the recognition event.

To export the event logs found:

1. Click the **CSV** button at the upper right of the Detail Log page.
2. Click **Event Query > Exported Files**.

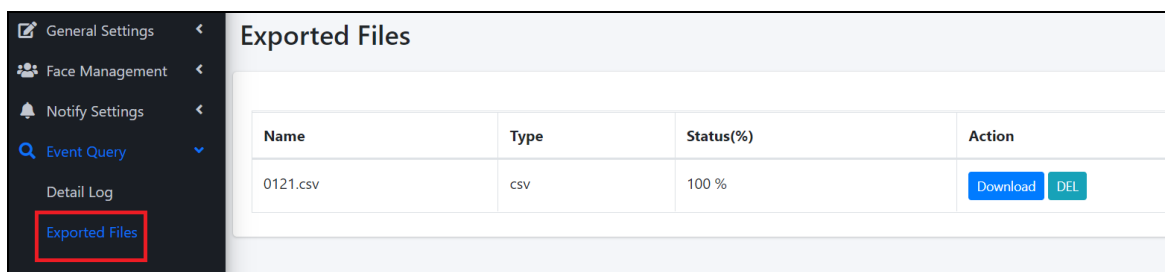

The screenshot shows the 'Exported Files' interface. The left sidebar has 'Exported Files' highlighted with a red box. The main area contains a table with the following data:

Name	Type	Status(%)	Action
0121.csv	csv	100 %	Download DEL

3. Click **Download**.

Chapter 6 Advanced Applications

This chapter introduces more advanced applications.

6.1 Upgrading System Firmware

GeoVision periodically updates the latest firmware to the company website. You can update GV-FR Panel's firmware through **GV-IP Device Utility** (V8.9.3 or later) from the [website](#).

Important Notes before You Start

Before you start updating the firmware, please read these important notes:

1. While the firmware is being updated, the power supply must not be interrupted.
2. If you use GV-IP Device Utility for firmware upgrade, the computer used to upgrade firmware must be within the same network as the GV-FR Panel.
3. If firmware upgrade fails, you will need to restore the GV-FR Panel to its default settings. For details, see *6.2 Restoring to Factory Default Settings*.

WARNING: The interruption of power supply during updating causes not only update failures but also damages to your GV-FR Panel. In this case, please contact your sales representative and send your device back to GeoVision for repair.

Using the GV-IP Device Utility

GV-IP Device Utility provides a direct way to upgrade the firmware to multiple GV-FR Panels.

Note: The computer used to upgrade firmware must be within the same network as the GV-FR Panel.

1. Once downloaded, select **GV IP Device Utility**, and follow the onscreen instructions to install the program.
2. Double-click the **GV IP Device Utility** icon created on your desktop. This dialog box appears.

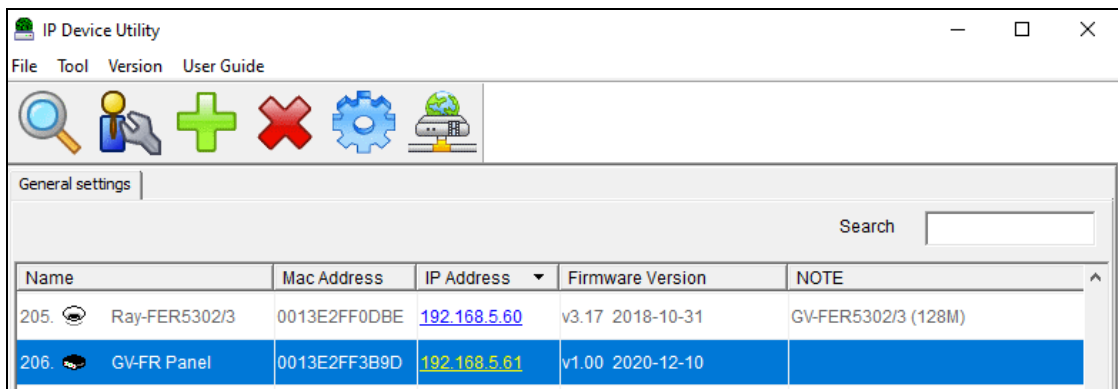

3. Click the **Search** button to locate available devices on the LAN, or click the **New** button and assign an IP address to locate a GV-FR Panel on the network.
4. Double-click on the IP address of the GV-FR Panel. This dialog box appears.

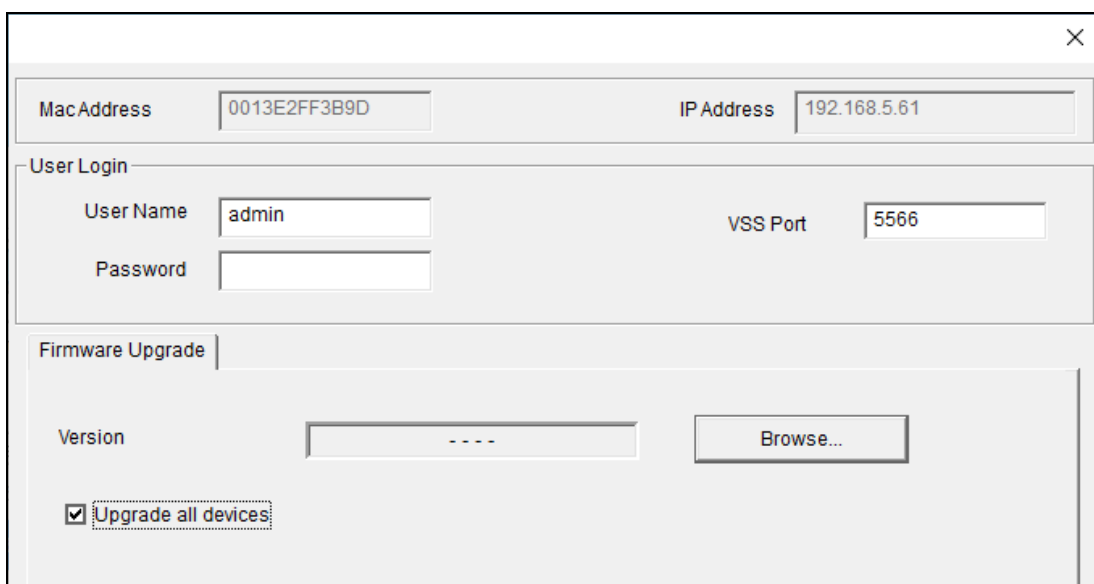

5. Click the **Browse** button to locate the firmware files (.img) saved at your local computer.
6. If you like to upgrade all the GV-FR Panels in the list, check **Upgrade all devices**.
7. Type **Password** of the GV-FR Panel, and click **Upgrade** to start the upgrade.

6.2 Restoring to Factory Default Settings

If for any reason the device is not responding properly, you can restore it to its factory default settings through the Web interface.

1. Click **General Settings > System Settings**.
2. Click **Load Default**.

6.3 GV-Face Manager for Face Database Management

GV-Face Manager is a useful utility that allows you to manage the face database of GV-FR Panel. It features the following functions for GV-FR Panel:

- **Creating face profiles:** See 2.2 *Adding / Editing Face IDs* in [GV-Face Manager User's Guide](#).
- **Synchronizing face databases among more than one GV-FR Panel:** See 2.5 *Synchronizing Databases* in *GV-Face Manager User's Guide*.
- **Importing and exporting a face database:** See 3.3 *Face Database Backup* in *GV-Face Manager User's Guide*.
- **Batch enrolling faces:** See 2.4 *Batch Enrolling Faces and Access Cards* in *GV-Face Manager User's Guide*.

WARNING: **Synchronizing** and **importing** face database can only work among the devices with the same engine versions (UI and Server versions). When applied the face database with a different engine version, GV-FR Panel will not recognize the faces registered.

You can check the engine versions from the Web interface of GV-FR Panel.

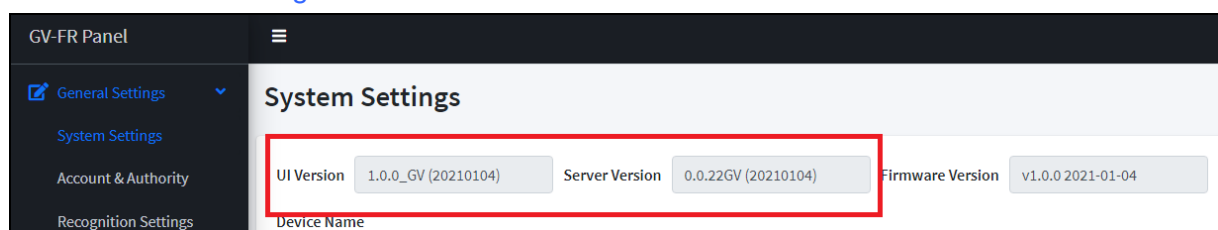

Starting GV-Face Manager

You can download GV-Face Manager from the [GeoVision's website](#).

1. Once downloaded and installed, double-click the **Face Manager** program to start.
2. Upon first-time startup, you are required to set a login ID and password for the Face Manager.
3. After logging in, click **Add Host**  and type the IP address, Port, the login ID and Password, and type a desired Host Name for the GV-FR Panel, and click **OK**.

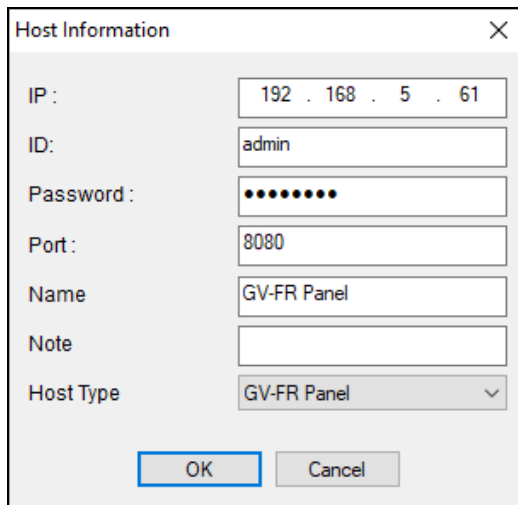

IP :	192 . 168 . 5 . 61
ID:	admin
Password :	••••••••
Port :	8080
Name	GV-FR Panel
Note	
Host Type	GV-FR Panel

OK Cancel

4. Once the GV-FR Panel is added and connected, you can use the Face Manager to create face profiles, synchronize and back up face databases. For details, see the related sections in *GV-Face Manager User's Guide*, as listed above.

Chapter 7 Third-Party Controller Integration

GV-FR Panel is able to send access data to and integrate with third-party access systems through Wiegand connection. There are two methods to connect GV-FR Panel to a third-party controller: via onboard Wiegand interface and via optional GV-FWC face data converter.

Note: Face images of recognition events cannot be sent to 3rd-party controllers through Wiegand connection.

7.1 Via Onboard Wiegand Interface

Use the Wiegand port on GV-FR Panel, as indicated below, to connect with a 3rd-party controller.

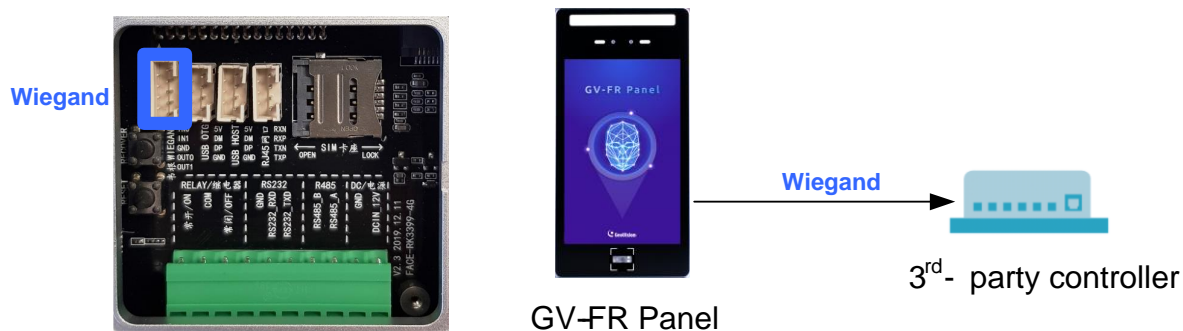

Note: If the third-party controller fails to respond to GV-FR Panel connected via its Wiegand interface, i.e., the access information received by GV-FR Panel wasn't transmitted to the third-party controller, please prepare two resistors of 3.3 or 4.7 k Ω , and apply the two resistors to the Wiegand interface. One is between D0 and 12 V, and the other between D1 and 12 V, as illustrated below.

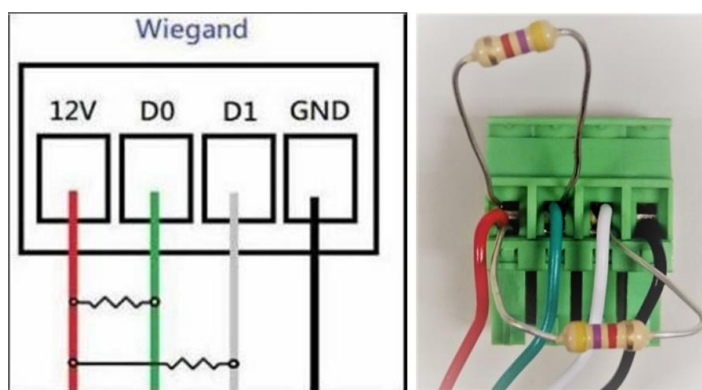

Connection Settings on GV-FR Panel

On the Web interface of GV-FR Panel, select **Notify Settings > Event Trigger > New Trigger**, and select **Wiegand Output** under Trigger Output. When recognition events occur, the information will also be sent to the controller connected via the Wiegand port.

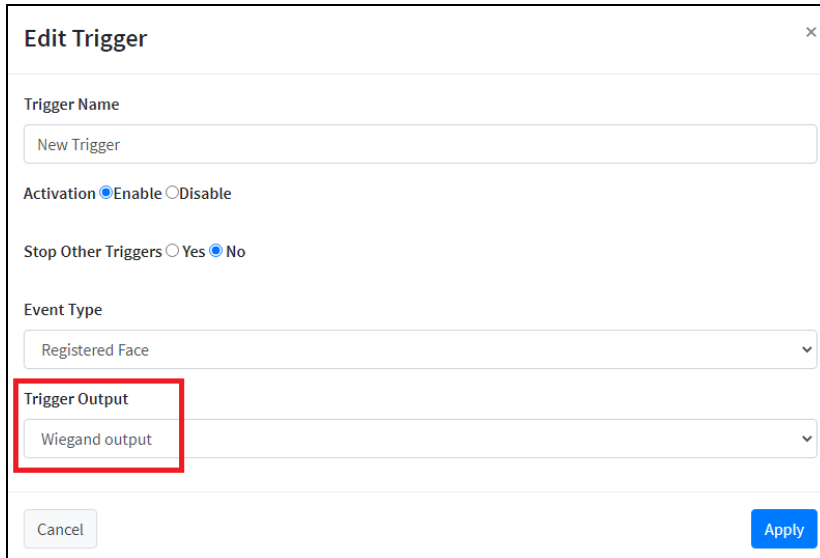

The screenshot shows the 'Edit Trigger' configuration window. It includes the following fields and options:

- Trigger Name:** A text input field containing 'New Trigger'.
- Activation:** Radio buttons for 'Enable' (selected) and 'Disable'.
- Stop Other Triggers:** Radio buttons for 'Yes' and 'No' (selected).
- Event Type:** A dropdown menu set to 'Registered Face'.
- Trigger Output:** A dropdown menu set to 'Wiegand output', which is highlighted with a red rectangular box.
- Buttons:** 'Cancel' and 'Apply' buttons at the bottom.

For details on the Event Trigger settings, see *5.3.2 Event Trigger*.

7.2 Via GV-FWC Converter

Through GV-FWC, a face recognition access data converter, GV-FR Panel is able to send access data to and integrate with third-party access systems.

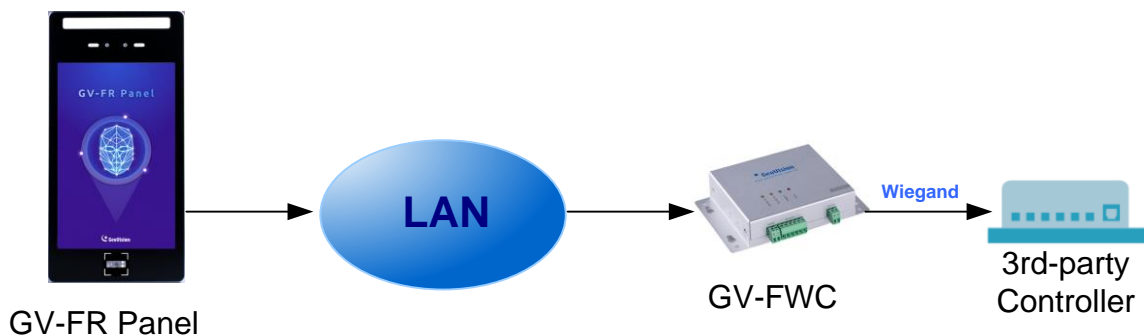

Note: Face images of recognition events cannot be sent to 3rd-party controllers through Wiegand connection.

Connection settings on GV-FR Panel

1. On the Web interface of GV-FR Panel, click **Notify Settings > GV-FWC/Controller**, and select **New GV-FWC/Controller**. This dialog box appears.

2. Name the GV-FWC to be connected, type its IP address, and select **On** next to **Activation**.
3. Type a 12-numerical long **Virtual MAC**, with 0 ~ 9, for the GV-FR Panel to be connected to GV-FWC.
4. Click **Apply**.

Connection settings on GV-FWC

5. On the Web interface of GV-FWC, click **Converter Mode Setting**. The Converter Mode Setting page appears.

6. Under **MAC Address**, type the Virtual MAC defined on the GV-FR Panel. See Step 3.
7. Under **Output Function**, select **Wiegand A** or **Wiegand B** where the 3rd-party controller is connected to.

8. Optionally modify the default HTTP Event Port of **8080** if needed.
9. Click **Submit** to apply the settings.

For more details on GV-FWC, see [GV-FWC Installation Guide](#).

Chapter 8 Live Streaming on GV-Software



Once you have connected GV-FR Panel to GV-VMS or GV-Edge Recording Manager, you can cast GV-FR Panel's live streaming on the two GV-Software for a more comprehensive surveillance management environment.

Note:

1. This function is only applicable to GV-FR Panel V1.40, GV-VMS V17.5.0 / V18.4.0, GV-Edge Recording Manager V2.2.0 and later versions.
 2. Live streaming is temporarily disabled on GV-Software while users are configuring GV-FR Panel's local settings.
 3. The talk back function is not supported on GV-Software when connecting to GV-FR Panel.
 4. GV-FR Panel only supports a single stream of 1080 x 1920, 480 x 720, or 480 x 640.
-

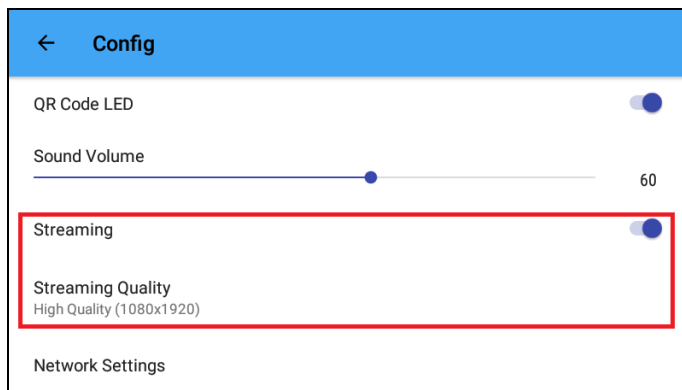
1. Enable **Streaming** on GV-FR Panel's local settings to allow the connection to GV-VMS. Optionally tap **Streaming Quality** to adjust the video resolution.



2. To add GV-FR Panel on GV-Software:
 - For GV-VMS, see *Chapter 2 IP Camera Setup* in [GV-VMS User's Manual](#) for details.
 - For GV-Edge Recording Manager, select **Add Host > Add IP Camera**. For details, see *2.3.2 Manually Adding a Host* in [GV-Edge Recording Manager User's Manual](#).
3. Once the connection is established, the live view of GV-FR Panel will appear on GV-Software.
4. To restore the original aspect ratio of GV-FR Panel images:
 - On the view window of GV-VMS, click **Tools**  > **Properties > Keep Image Ratio**.
 - On the view window of GV-Edge Recording Manager, click **Configure**  > **Properties > Keep Image Ratio**.

Specifications

For details, see the [datasheet](#).

Appendix

Verifying the Connection between GV-FR Panel and GV-AS Controller

To verify if GV-FR Panel is connected to GV-AS Controller successfully, go to the Web interface of the GV-AS Controller (Extended Device > Extended Reader Configuration), as exemplified below, and check the following settings:

- The Virtual MAC of the GV-FR Panel should be listed under **Serial Number** of the **GV-Reader/CR420/GF1921/GF1922 Function**.
- The door corresponding to the GV-FR Panel should be selected under **Function**.
- The RS-485 checkbox should not be selected.

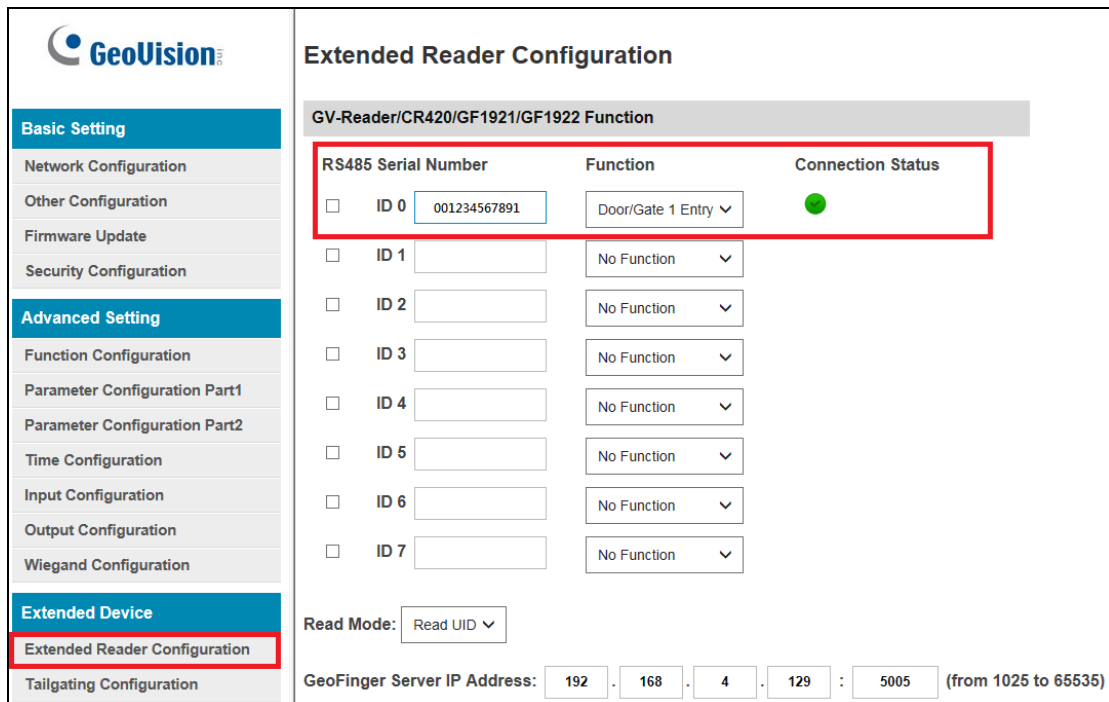

Extended Reader Configuration

GV-Reader/CR420/GF1921/GF1922 Function

RS485 Serial Number	Function	Connection Status
<input type="checkbox"/> ID 0 001234567891	Door/Gate 1 Entry	●
<input type="checkbox"/> ID 1	No Function	
<input type="checkbox"/> ID 2	No Function	
<input type="checkbox"/> ID 3	No Function	
<input type="checkbox"/> ID 4	No Function	
<input type="checkbox"/> ID 5	No Function	
<input type="checkbox"/> ID 6	No Function	
<input type="checkbox"/> ID 7	No Function	

Read Mode: Read UID

GeoFinger Server IP Address: 192 . 168 . 4 . 129 : 5005 (from 1025 to 65535)

Optional Installation

GV-Mount800

You can optionally purchase GV-Mount800 to mount the GV-FR Panel on a surface.

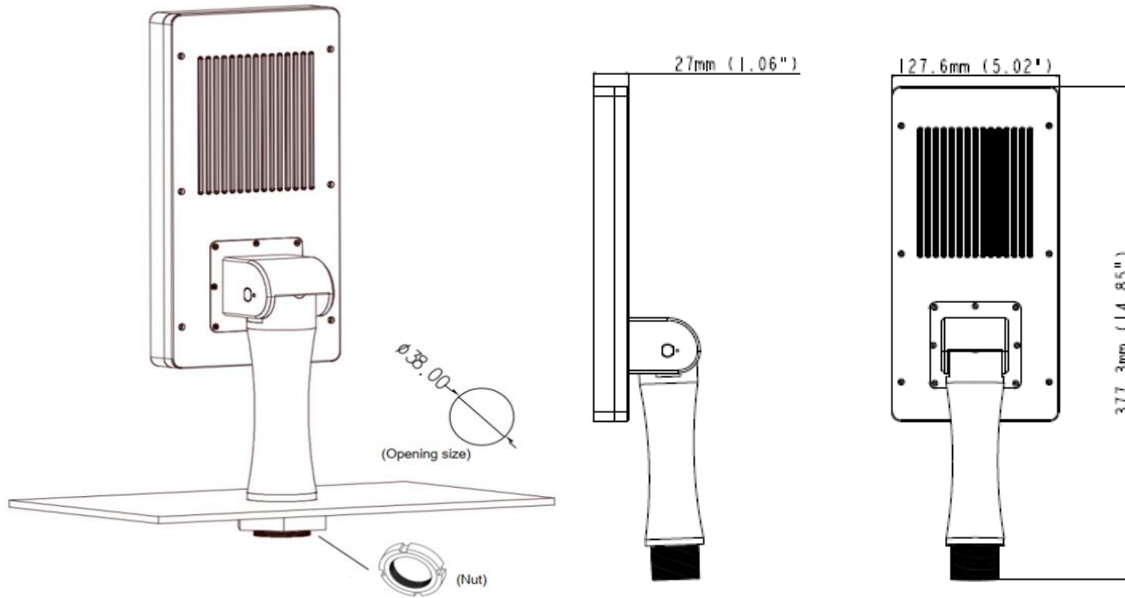

GV-Mount800 Packing List

1. GV-Mount800	2. Securing Nut
3. Screw x 7	4. Hex Wrench

1. Drill a 38-mm-diameter hole on the desired surface for installing the GV-Mount800.
2. Detach the securing nut from the GV-Mount800.



3. Place and secure the GV-Mount800 onto the surface by using the securing nut.

4. Once the GV-Mount800 is properly installed, place the large sealing rubber of the GV-FR Panel onto the back of the panel.
5. Attach and secure the GV-FR Panel onto the GV-Mount800 with the 7 screws supplied to complete the installation.

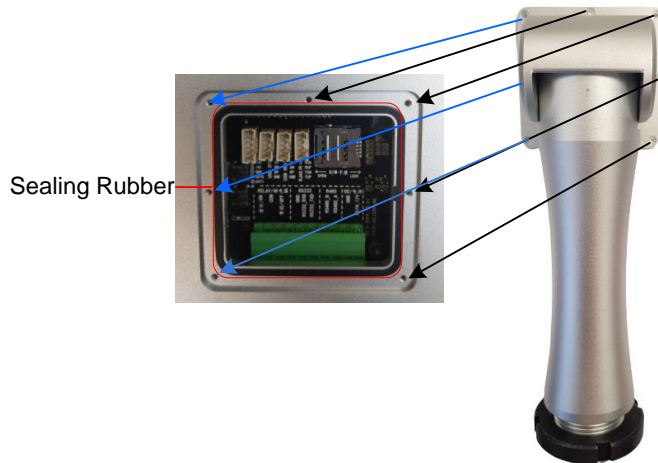

Note: Thread the necessary cables through the GV-Mount800 and connect them to the panel before securing the cover.

6. Optionally use the supplied hex wrench to adjust the tilt angle of the GV-Mount800



GV-Mount801

You can optionally purchase GV-Mount801 to install the GV-FR Panel at other locations using the **Mobile** or **Stationary** installation.



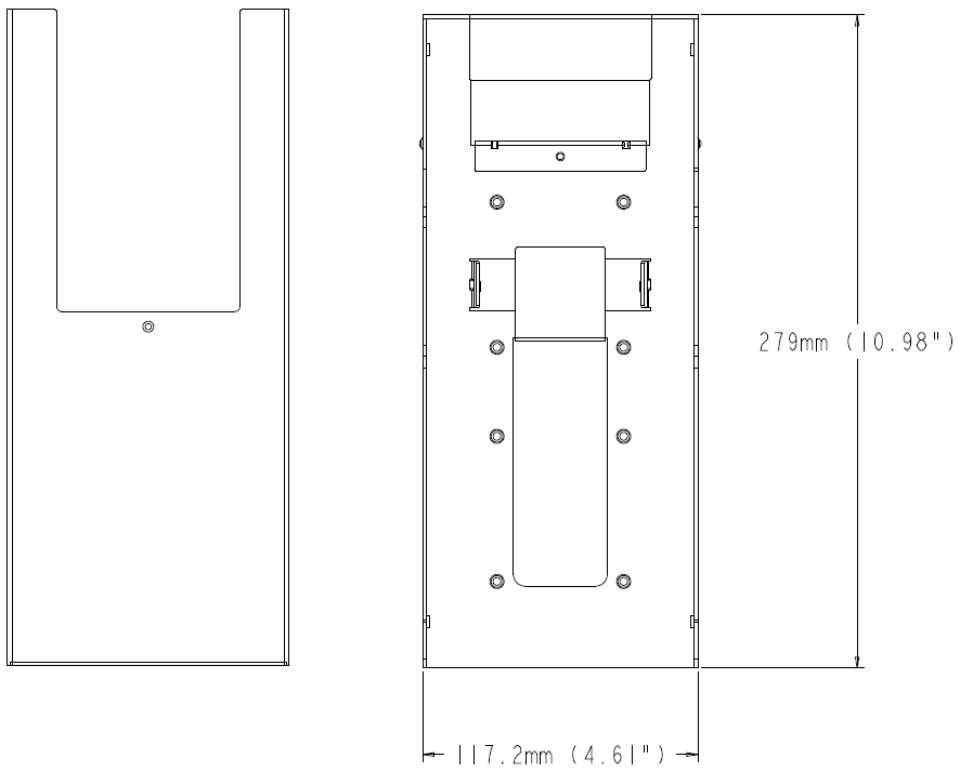
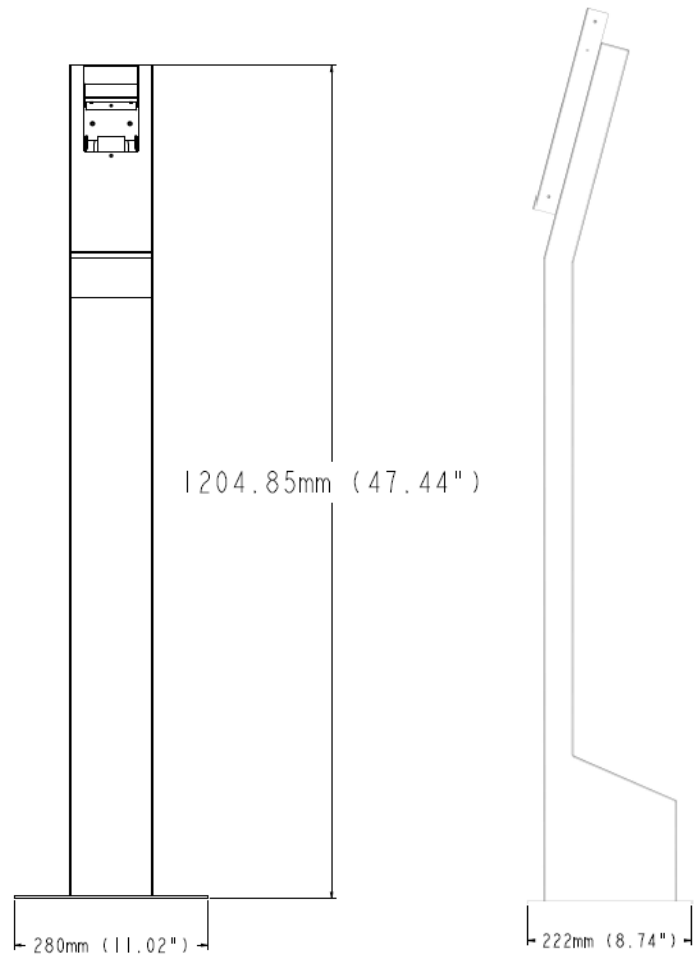

GV-Mount801 Packing List

<p>1. GV-Mount801</p>	<p>2. Mount Base</p> 
<p>3. Panel Box Base</p> 	<p>4. Mount Base Cover</p> 
<p>5. Panel Box Cover</p> 	<p>6. Mount Base Cover Screw (M3 x 8 mm) x 4</p> 
<p>7. Panel Box Side Screw (M3 x 6 mm) x 4</p> 	<p>8. Upper Mount Stand Cover</p> 
<p>9. Panel Box Base Screw (M4 x 6.5 mm) x 4</p> 	<p>10. Lower Mount Stand Cover</p> 
<p>11. Nut x 3</p> 	<p>12. Mount Stand Cover Screw (M3 x 8 mm) x 12</p> 
<p>13. Plastic Cover</p>	<p>14. Power Adapter Duct</p> 
<p>15. Ground Bolt x 3 (Ground)</p> 	<p>16. Power Adapter Duct Screws (M3 x 8 mm) x 4</p> 
<p>17. Large Rubber Plug x 2</p> 	<p>18. Small Rubber Plug x 4</p> 
<p>Note: The Mount Base Cover Screws, Mount Stand Cover Screws, and Power Adapter Duct Screws are identical.</p>	

Mobile Installation

This type of installation allows you to freely install and move your GV-FR Panel from one place to another. Make sure the power source and network are within reach for connection.

Installing the Mounting Plate to GV-FR Panel

1. Begin by threading the GV-FR Panel's cable connectors through the following items in numerical order.
 - 1-1. Large sealing rubber (included in the Wall Mount Bracket kit, *1.2 Packing List*)
 - 1-2. Back cover of the GV-FR Panel
 - 1-3. Small sealing rubber (included in the Wall Mount 1-Bracket kit, *1.2 Packing List*)
 - 1-4. Mounting plate (included in the Wall Mount Bracket kit, *1.2 Packing List*)
2. Embed the large sealing rubber and the back cover onto the back of the GV-FR Panel.

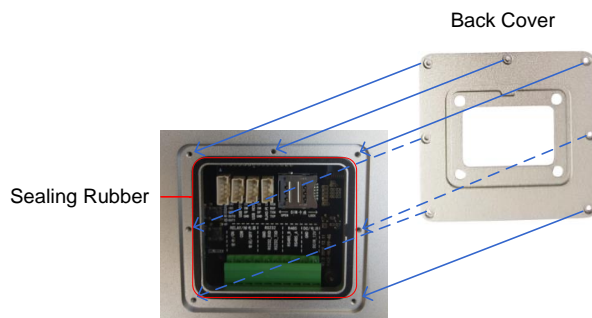

3. Embed the small sealing rubber onto the back cover, and then attach and secure the mounting plate onto the GV-FR Panel with the back cover screws (included in the Wall Mount Bracket kit, *1.2 Packing List*).

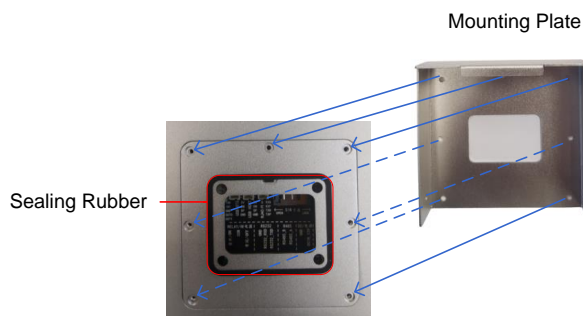

Mounting the GV-FR Panel

- Remove both mount stand covers behind the mount stand.



Back of Mount Stand

- Use a self-prepared hex wrench to secure the mount stand to the mount base with the supplied nuts  at the indicated holes.



Mount Base

- Align the desired set of holes on the panel box base (Set 1 or Set 2 as illustrated below) to the four holes on the mount stand, and then insert the supplied panel box base screws  (M4 x 6.5 mm) **from the upper opening behind the mount stand** to secure them.





Front of Panel Box Base

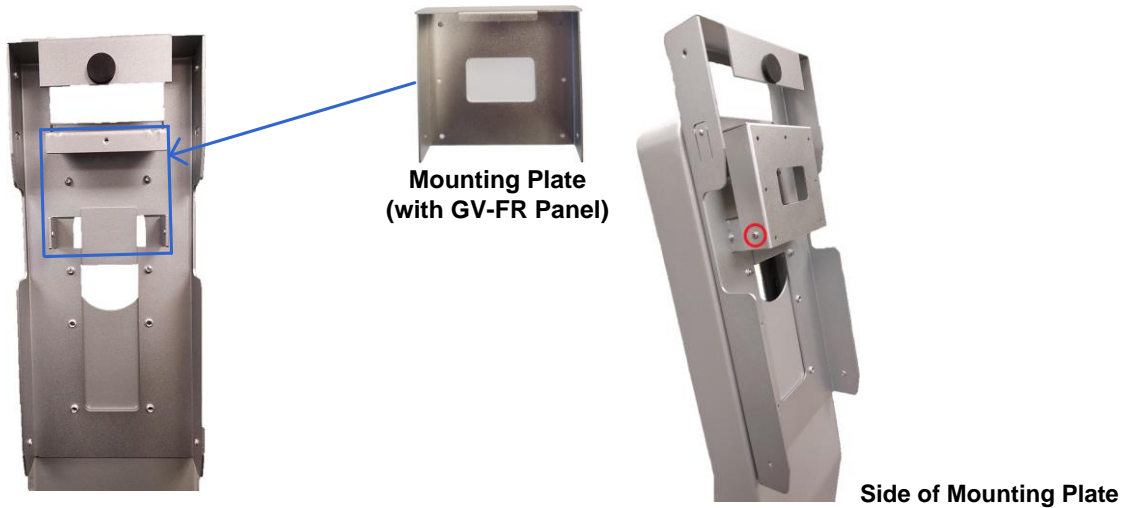

Back of Panel Box Base

7. To install GV-FR Panel onto GV-Mount801, thread the cables on GV-FR Panel into the panel box base, and then close the upper mount stand cover.
8. Latch the mounting plate (with GV-FR Panel) onto the protruding part of the panel box base, and then tighten a mounting plate side screw (included in the Wall Mount Bracket kit, *1.2 Packing List*) onto each side of the mounting plate.



9. Cover the panel box base by sliding the panel box cover from below, and then insert two panel box side screws  (M3 x 6 mm) on each side of the panel box cover to secure the panel box.



10. Use the lower opening behind the mount stand to connect GV-FR Panel to the necessary power adapter, Ethernet cable or output device. Once done, close the lower mount stand cover.

Note: You can optionally install the power adapter duct on the lower mount stand cover to secure your power adapter. To do so, follow the steps below.

1. Place the power adapter in the power adapter duct and onto the lower mount stand cover as shown below.

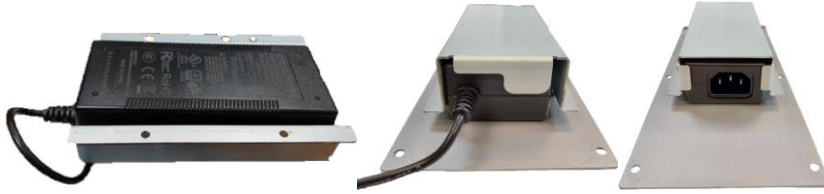

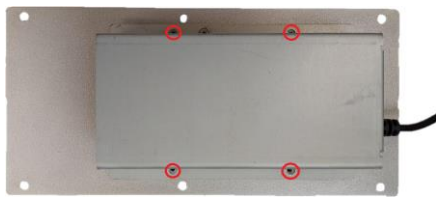

2. Secure the power adapter duct using the supplied power adapter duct screws  (M3 x 8 mm).



-
11. Thread the connected cables further down the mount stand, through the opening at the mount base, and then close the mount base cover with the mount base cover screws  (M3 x 8 mm).



12. Insert the large  and small  rubber plugs to the side of the mount stand as shown below.



Stationary Installation

This type of installation will fix your GV-FR Panel at a single location. Please note the following precautions before you begin, as the installation requires drilling three permanent holes on a surface.

- Make sure no other pipes or wires are embedded below the desired surface
 - Make sure the network and power source are within reach for connection
 - Avoid installing on fragile materials, such as ceramic tiles
1. Follow Step 1 to 4, *Mobile Installation* to install GV-FR Panel and open the mount stand covers.
 2. Place the mount stand on the desired surface (vertically) and use a marker to mark the three indicated holes. Use a self-prepared screw gun to drill each hole with a diameter of 8.5 mm (0.33 in) and a depth of 58 mm (2.28 in).

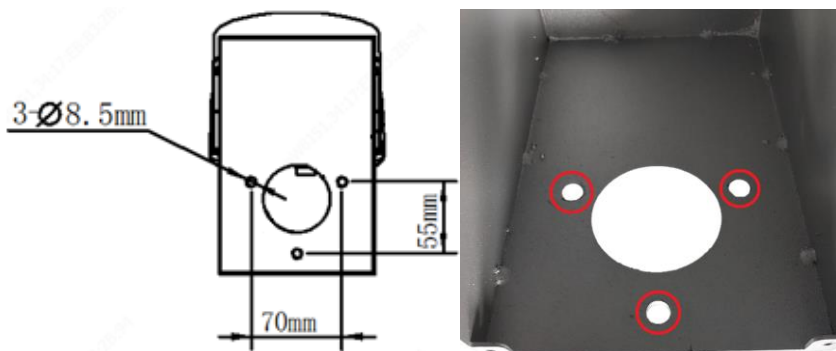

3. Take apart each ground bolt as shown in the figure below, insert each No. 1 upside down into the drilled holes, and then fit each No. 2 back on No. 1.

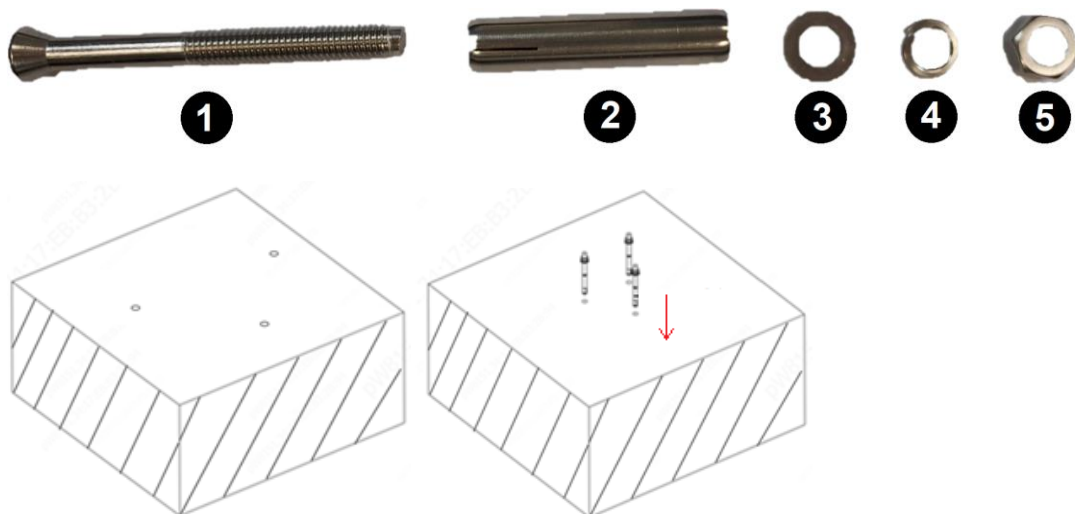

4. Use a self-prepared hex wrench to secure the mount stand to the surface with No. 3, 4 and 5 (refer to Step 3).

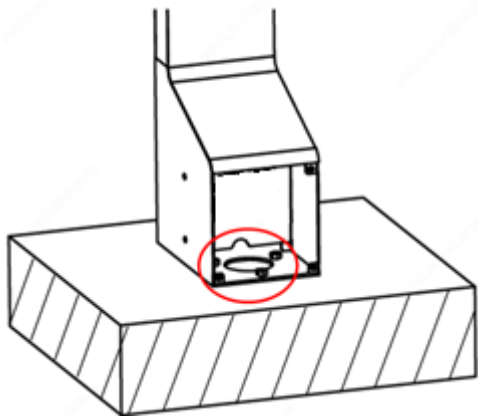





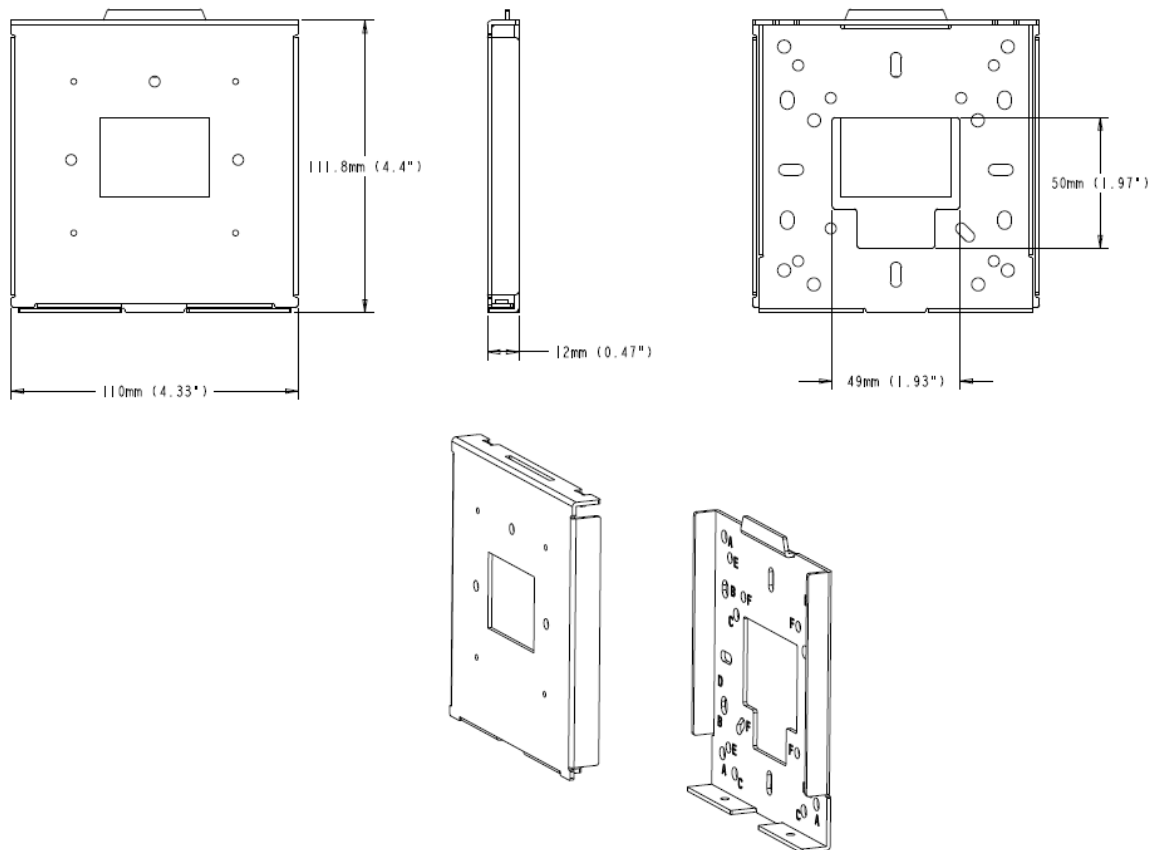

5. Follow Step 6 to 12, *Mobile Installation* to complete the GV-Mount801 installation.

GV-Mount920

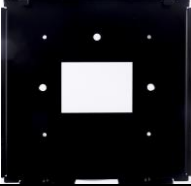
You can optionally purchase the GV-Mount920 to mount the GV-FR Panel on a surface, power box, or VESA mount.



GV-Mount920 Packing List

<p>1. Wall Mount Bracket Top</p> 	<p>2. Wall Mount Bracket Base</p> 
<p>3. Screw Anchor x 4</p> 	<p>4. M3.5*L32 Screw x 4</p> 
<p>5. Torx Wrench x1</p> 	<p>6. M3x4 Screw x 2</p> 
<p>7. M2x6 Screw x 7</p> 	

Installing the GV-FR Panel to Surfaces

1. Drill holes on the desired surface for installing the GV-Mount920.
2. Place and secure the Wall Mount Bracket Base onto the desired surface with screws and anchors supplied.
3. Place the back cover with the sealing rubber onto the rear panel of GV-FR Panel.



4. Place and secure the Wall Mount Bracket Top onto the rear panel with the 7 M2x6 screws supplied.



5. Tilt the GV-FR Panel and slide it down to integrate the Wall Mount Bracket Top and Base.

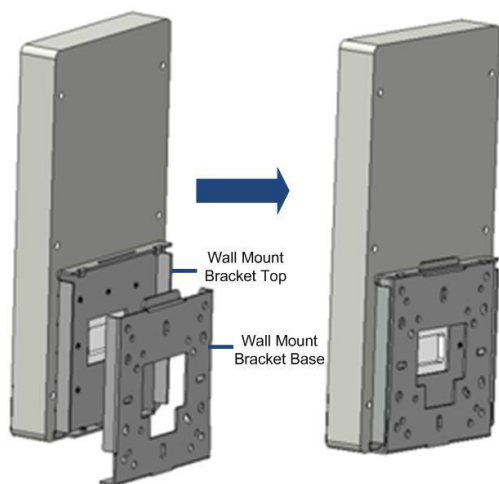

6. Secure the bottom of the Wall Mount Bracket Top and Base with 2 M3x4 screws supplied and complete the installation.

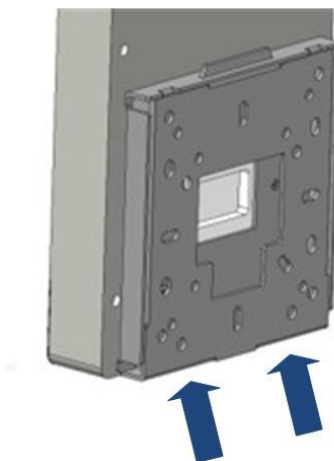

Installing the GV-FR Panel to Different Types of Power Boxes or VESA Mounts

- The GV-FR Panel can be installed onto 4 types of power boxes with the GV-Mount920. On the Wall Mount Bracket Base, the corresponding holes for each type are marked with A-F:

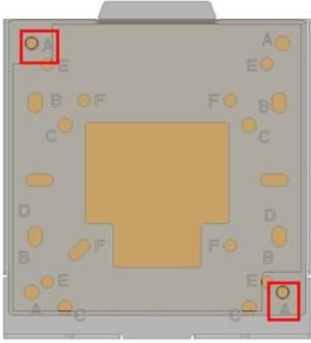
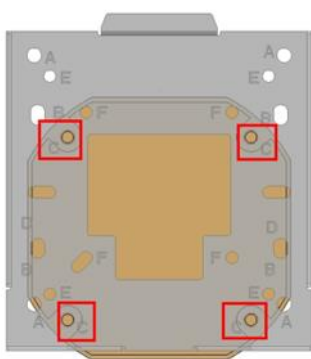
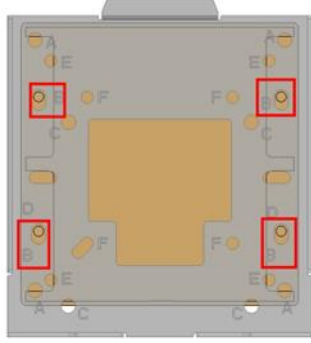
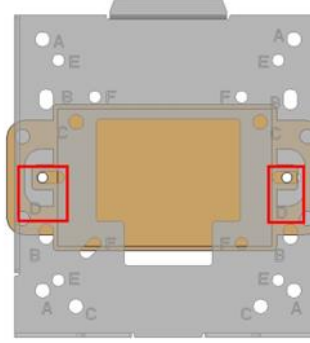
Type of Power Box	Hole	Type of Power Box	Hole
<p>4" Square</p> 	A	<p>Double Gang</p> 	B
<p>4" Octagon</p> 	C	<p>Single Gang</p> 	D

- To install the GV-FR Panel onto VESA mounts with the GV-Mount920, 2 types of screw holes are applicable:

Type of Screw Hole	
75*75mm VESA Mount	Hole E
50*50mm VESA Mount	Hole F

Note: The screws for installing the GV-Mount920 onto power boxes or VESA mounts are not included in the kit.