

GV-TBL4810 AI 4MP H.265 5x Zoom Super Low Lux WDR Pro IR Bullet IP

Camera



- AI deep learning: AI Perimeter Protection & Classification (Human, Vehicle)
- 1/3" progressive scan super low lux CMOS sensor
- Min. illumination at 0.002 lux
- Triple streams from H.265, H.264 or MJPEG
- Wide Dynamic Range Pro (WDR Pro)
- Up to 30 fps at 2688 x 1520
- Motorized lens for remote focus / zoom adjustment
- Intelligent IR
- IR distance up to 50 m (165 ft)
- Day and night function (with removable IR-cut filter)
- Vandal Resistance (IK10 for metal casing)
- Ingress protection (IP67)
- Built-in micro SD card slot (SD / SDHC / SDXC / UHS-I, Class 10) for local storage
- Two-way audio capable
- DC 12V / PoE (IEEE 802.3af)
- ONVIF (Profile G, S, T, M) conformant



Introduction

GV-TBL4810 is an outdoor, network camera equipped with an automatic IR-cut filter and IR LEDs for day and night surveillance. The camera supports H.265 video codec to achieve better compression ratio while maintaining high quality pictures at reduced network bandwidths. The camera adheres to IK10 and IP67 standards, and can be powered through PoE.

Empowered by deep learning algorithms, AI technology distinguishes human and vehicles from other moving objects. Integrated with GeoVision Video Management Software (VMS), it supports AI perimeter protection, real time alert, event playback and more.

Deep Learning Function

Face Detection

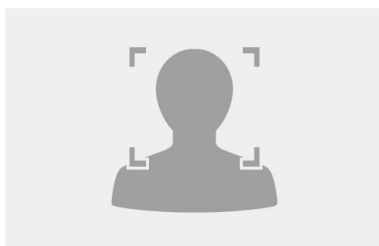

AI Perimeter Protection

(Intrusion, Crossing Line
Entering Area, Leaving Area)

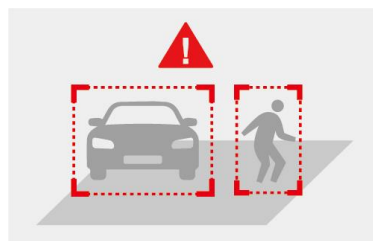

People Flow Counting

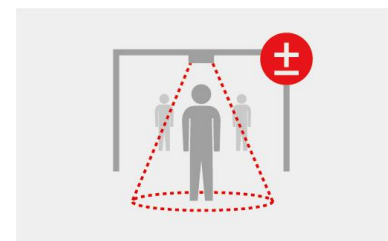

Dimensions

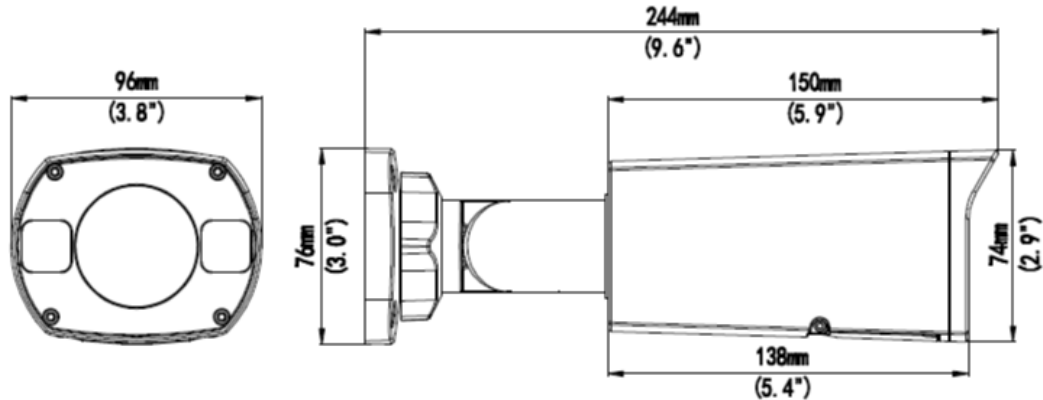

Specifications

Camera					
Image Sensor		1/3" progressive scan super low lux CMOS			
Picture Elements		2688 (H) x 1520 (V)			
Minimum Illumination	Color	0.002 Lux (F1.2, AGC ON)			
	IR On	0 Lux			
Shutter Speed		Auto / Manual (1 ~ 1/100000 sec)			
White Balance		Automatic, Manual			
Gain Control		Automatic, Manual			
S/N Ratio		56 dB			
WDR Pro		Yes			
Dynamic Range		120 dB			
Lens					
Megapixel		4 MP			
Day / Night		Yes (with removable IR-cut filter)			
Lens Type		Motorized varifocal lens			
Focal Length		2.7 ~ 13.5mm			
Maximum Aperture		F/1.2			
Mount		Ø14 mm			
Horizontal FOV		98°~31°			
Operation	Focus	Auto / Manual			
	Zoom	5x Optical Zoom			
	Iris	Fixed			
IR LED Quantity		3 IR LEDs			
Max. IR Distance		50 m (165 ft)			
DORI		Detect	Observe	Recognize	Identify
Lens	2.7 mm	60.8 m (199.5 ft)	24.3 m (79.7 ft)	12.2 m (40 ft)	6.1 m (20 ft)
	13.5 mm	303.8 m (996.7 ft)	121.5 m (398.6 ft)	60.8 m (199.5 ft)	30.4 m (99.7 ft)
Operation					
Video Compression		H.265, H.264, MJPEG			
Video Streaming		Triple streams			
Frame Rate		30 fps at 2688 x 1520 / 2560 x 1440 / 2304 x 1296 (60 / 50 Hz) * The frame rate and performance may vary depending on the number of connections and data bitrates (different scenes).			
Video Analytics		Motion Detection, Tampering Alarm, Audio Detection. *Tampering alarm and audio detection are only accessible through the camera's Web interface, which can be used to trigger alerts such as e-mail and FTP			
Image Setting		Brightness, Contrast, Saturation, Sharpness, Flicker-less, 3D Noise Reduction, Image Orientation (Flip, Mirror, 0°, 90°, 180°, 270°-including Corridor format).			
Audio Compression		G.711			
Audio Support		Two-way Audio (external microphone and speaker required)			
Digital I/O	Input	1 Input, dry contact, NO / NC			
	Output	1 Relay Output (1A 30V DC / 0.3A 125V AC)			

Face Detection		
Environment		100 lux
Detectable face angle	Tilt (Up/Down)	≤ 10°
	Swing (Left/Right)	≤ 30°
Max. number of faces		Up to 40
Min. face image pixel requirement		80 pixels
Deep Learning Function		
AI Analytics		- Intrusion, Crossing Line, Entering Area, Face Detection, Leaving Area: Human & Vehicle classification - People Flow Counting, Crow Density Monitoring
Video Resolution		
Main Stream		2688 x 1520 (Default), 2560 x 1440, 2304 x 1296, 1920 x 1080, 1280 x 720
Sub Stream		1280 x 720, 720 x 576, 640 x 360 (Default), 640 x 480
Third Stream (Closed by Default)		720 x 576, 704 x 288, 640 x 360, 352 x 288
Network		
Interface		10/100 Ethernet
Protocol		802.1x, ARP, DHCP, DDNS, DNS, DynDNS, FTP, HTTP, HTTPS, ICMP, IGMP, IPv4, IPv6, NTP, PPPoE, QoS, RTP, RTSP, SMTP, SNMP, TCP, UDP, UPnP, ONVIF (Profile G, S, T, M)
Mechanical		
Camera Angle Adjustment	Pan	0 ~ 360°
	Tilt	0 ~ 90°
	Rotate	0 ~ 360°
Connectors	Power	DC Jack, PoE
	Ethernet	RJ-45
	Audio	1 in (Audio In Wire); 1 out (Audio Out Wire) *The Audio In port only supports microphones with power supply
	Digital I/O	4-pin terminal block pitch 3.5 mm (0.14")
	Local Storage	Micro SD card slot (SD / SDHC / SDXC / UHS-I, Class 10) * UHS-II card type is not supported.
General		
Operating Temperature		-30 ~ 60°C (-22 ~ 140°F)
Humidity		0 ~ 95% (no condensation)
Power Source		12 V DC / PoE (IEEE802.3af)
Max. Power Consumption		8.5W
Dimensions		244 x 96 x 74 mm (9.6" x 3.8" x 2.9")
Weight		1.0 kg (2.2 lb)
Ingress Protection		IP67
Vandal Resistance		IK10 for metal casing
Certification		CE, FCC, RoHS, UL compliant
Certification		
Installation Management		Web-based configuration
Maintenance		Firmware upgrade through Web Browser or Utility
Access from Web Browser		Live View, Video Recording, Change Video Quality, Bandwidth Control, Image Snapshot, Text Overlay, Image Masking
Language		Czech, English, French, German, Hungarian, Italian, Japanese, Polish, Portuguese, Russian, Spanish, Traditional Chinese
Applications		
Software Supported		GV-VMS (V17.4.2 / V18.2.1), GV-DVR / NVR (V8.9.1), GV-Control Center (V3.8.0), GV-Recording Server / Video Gateway (V2.0.0), GV-Edge Recording Manager Win version (V2.0.0), GV-Redundant / Failover Server (V1.2.0), GV-Mobile Server (V1.5.1)
Smart Device Access		GV-Eye for iOS and Android
Live Viewing		Browser (IE, Edge, Chrome, Firefox, Safari), Mobile App





Note:

1. Patch files are required for some supported software.
2. Do not use clothes or any ordinary material to clean the camera cover since they may result in scratches.
3. Specifications are subject to change without notice.

Packing List

1. GV-TBL4810 Bullet
2. Waterproof Rubber Set
3. Screw Kit
4. Drill Template Paster
5. Download Guide

Accessories

Model No.	Name		Details
GV-Mount300-2	Convex Corner Mount		Dimensions: 137 x 233 x 160 mm (5.4" x 9.17" x 6.3") Weight: 1.65 kg (3.64 lb)
GV-Mount310-2	Concave Corner Mount		Dimensions: 111.2 x 369.9 x 210 mm (2.6" x 11.4" x 6.6") Weight: 1.65 kg (3.64 lb)
GV-Mount420 (must be used with GV-Mount503)	Pole Mount Bracket		Dimensions: \varnothing 120 x 120 x 53.4 mm (\varnothing 4.7" x 4.7" x 2.1") Weight: 0.45 kg (0.99 lb) Steel Strap Diameter: \varnothing 67 ~ 127 mm (\varnothing 2.6" ~ 5")
GV-Mount503	Wall Mount Bracket		Dimensions: 125 x 125 x 55 mm (4.9" x 4.9" x 2.2") Weight: 0.74 kg (1.63 lb)
GV-PA191	Power over Ethernet (PoE) Adapter		GV-PA191 is a Power over Ethernet (PoE) adapter designed to provide power to the IP device through a single Ethernet cable.
GV-POE Switch			GV-POE Switch is designed to provide power along with network connection for IP devices. The GV-POE Switch is available in various models with different numbers and types of ports.
Power Adapter			Contact our sales representatives for the countries and areas supported.