

GV-Mount Accessories

Installation Guide



Before attempting to connect or operate this product,
please read these instructions carefully and save this manual for future use.

MT-AP



© 2024 GeoVision, Inc. All rights reserved.

Under the copyright laws, this manual may not be copied, in whole or in part, without the written consent of GeoVision.

Every effort has been made to ensure that the information in this manual is accurate. GeoVision, Inc. makes no expressed or implied warranty of any kind and assumes no responsibility for errors or omissions. No liability is assumed for incidental or consequential damages arising from the use of the information or products contained herein. Features and specifications are subject to change without notice.

GeoVision, Inc.
9F, No. 246, Sec. 1, Neihu Rd.,
Neihu District, Taipei, Taiwan
Tel: +886-2-8797-8377
Fax: +886-2-8797-8335
<http://www.geovision.com.tw>

Trademarks used in this manual: *GeoVision*, the *GeoVision* logo and *GV* series products are trademarks of GeoVision, Inc. *Windows* is the registered trademark of Microsoft Corporation.

April 2024

Scan the following QR codes for product warranty and technical support policy:



[Warranty]



[Technical Support Policy]

Contents

Notice	vi
Note for Installing Camera Outdoor	vii
Note for Supported Power Box Types	viii
Note for the IP LPR Camera	ix
Note for the Fisheye Camera with IR LED	x
1. Introduction	1
1.1 Accessories List	1
1.2 Dimensions	10
1.3 Packing Lists	30
2. Installing the Fixed IP Dome	54
2.1 Basic Installation	54
2.1.1 Assembling the Fixed IP Dome with the Dome Housing.....	54
2.1.2 Putting on the Housing Cover	56
2.2 Straight Tube Box Mount.....	57
2.3 Straight Tube Mount.....	61
2.4 Wall Mount	64
2.5 Wall Box Mount	67
2.6 Wall Pendant Mount	69
2.7 Convex Corner Mount	71
2.8 Convex Corner Box Mount	73
2.9 Concave Corner Mount	77
2.10 Pole Mount	79
2.11 Pole Box Mount	81
2.12 Power Box Mount	84
3. Installing the Fisheye Camera	86
3.1 Dome Housing.....	86
3.1.1 GV-FER12700	86
3.1.2 GV-QFER12700.....	88
3.2 Straight Tube Box Mount.....	91
3.3 Straight Tube Mount.....	95
3.4 Wall Mount Bracket	97
3.5 Wall Pendant Mount	100

3.6 Tilting Wall Mount.....	101
3.7 Convex Corner Mount	104
3.8 Convex Corner Box Mount	106
3.9 Concave Corner Mount	109
3.10 Pole Mount	111
3.11 Pole Box Mount	113
3.12 Power Box Mount	116
3.13 Swan Neck Mount	119
4. Installing the GV-IP Speed Dome.....	124
4.1 Assembling Outdoor IP Speed Dome with Pendant Tube.....	124
4.2 Straight Tube Box Mount.....	129
4.3 Straight Tube Mount.....	134
4.4 Convex Corner Mount	136
4.5 Convex Corner Box Mount	137
4.6 Concave Corner Mount	140
4.7 Pole Mount	141
4.8 Pole Box Mount	142
4.9 Swan Neck Mount	145
5. Installing the Target Bullet / LPR Camera	151
5.1 Note for Closing the Bullet Camera Cover	151
5.2 Convex Corner Mount	152
5.3 Concave Corner Mount	154
5.4 Pole Mount	156
6. Installing the Box Camera with the Housing	158
6.1 Note for Installing the Housing.....	158
6.2 Assembling the Box Camera with the Housing	159
6.2.1 GV-Housing102	159
6.2.2 GV-Housing103	165
6.3 Convex Corner Mount	171
6.4 Concave Corner Mount	173
6.5 Pole Mount	175
7. Installing the IP LPR Camera.....	177
7.1 Convex Corner Mount	177

7.2 Concave Corner Mount	179
7.3 Pole Mount	181
8 Installing the Mini Fixed Dome.....	183
8.1 Wall Mount Bracket	183
8.2 Power Box Mount.....	185
9. Installing the Target Fixed Dome	187
9.1 Wall Mount Bracket	187
9.2 Power Box Mount.....	189
10. Installing the Vandal Proof Dome	192
10.1 Wall Mount Bracket	192
10.2 In-Ceiling Mount	195
10.3 Assembling Dome Housing	119
10.4 Wall Pendant Mount	200
10.5 Straight Tube Mount	202
10.6 Straight Tube Box Mount.....	204
10.7 Convex Corner Mount with Pendant Tube	206
10.8 Convex Corner Box Mount	208
10.9 Concave Corner Mount with Pendant Tube	210
10.10 Pole Mount	211
10.11 Pole Box Mount	213

Notice

For installation instructions, certain accessories are numbered to correspond to the item numbers in the packing list for each GV-Mount model. See *1.3 Packing Lists*.

For instance, in the second step of *2.1.1 Assembling the Fixed IP Dome with the Dome Housing*, "Secure the camera body to the housing plate (**GV-Mount902, No. 6**) with 3 small screws (**GV-Mount902, No. 7**)" refers to GV-Mount902 packing list **items 6 and 7**.

- **GV-Mount902**

1. Dome Housing 	2. Housing Cap 
3. M4 Screw x 8 	4. M6 Screw x 7 
5. Left and Right Rack 	6. Housing Plate 
7. Small Screw x 5 	

Note for Installing Camera Outdoor

When installing the camera outdoor, be sure that:

1. The camera is set up above the junction box to prevent water from entering the camera along the cables.

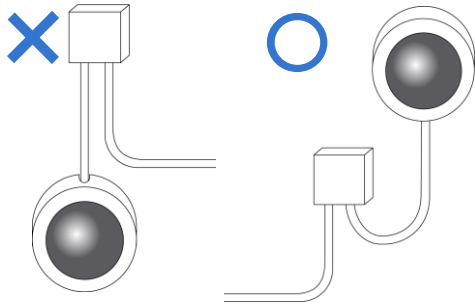

2. Any network, power, audio and I/O cables are waterproofed using waterproof silicon rubber or the like.

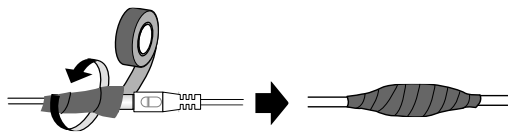

3. To prevent the lens from fogging up, ensure to replace the silica gel bag/desiccant pack every time you open the camera, and conceal the gel bag/desiccant pack in the camera within 2 minutes of exposing to open air. The silica gel bag/desiccant loses its effectiveness when the dry camera is opened.
4. For each newly replaced silica gel bag, allow it to absorb moisture for at least 5 hours before operating the camera.
5. After opening the camera cover, ensure the screws are tightened and the cover is in place.

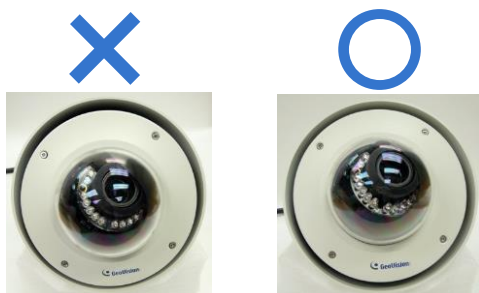

Note for Supported Power Box

Types

The supported power box types and required accessories are detailed below:

Camera Type	Required Accessory	Supported Power Box Type			
		Single Gang	Double Gang	4" Octagon	4" Square
FER Series	GV-Mount912	✓	✓	✓	✓
GV-QFER12700	GV-Mount912-1	✓	✓	✓	✓
GV-FD Series	GV-Mount913	✓	✓	✓	✓
GV-MFD Series GV-EFD Series	GV-Mount910	✓	✓	✓	
	GV-Mount913	✓	✓	✓	✓
GV-VD Series	N/A		✓		✓

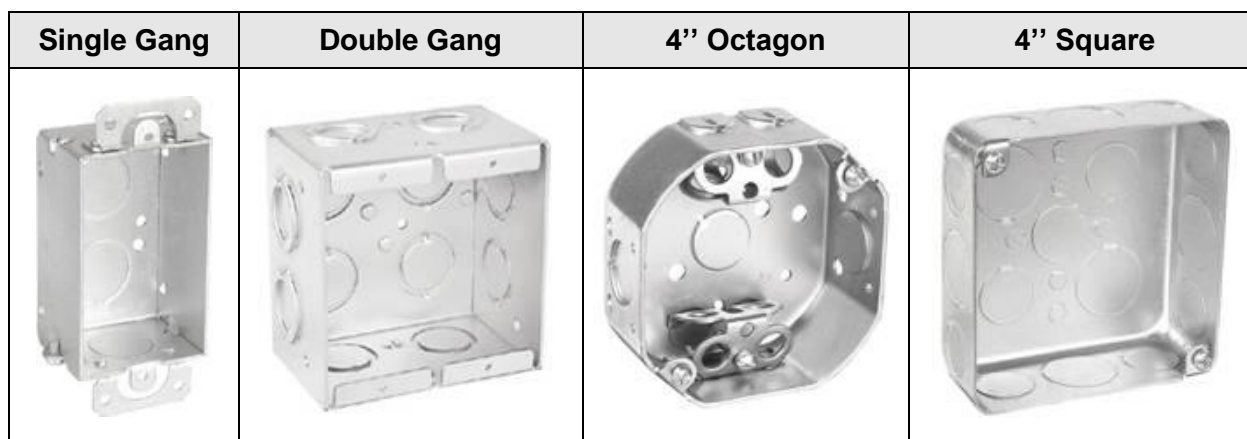

For the Power Box Mount, see the related sections in *Chapter 2* for GV-FD Series, *Chapter 3* for GV-Fisheye Series, *Chapter 8* for GV-MFD Series, and *Chapter 9* for GV-EFD Series.

Note for the IP LPR Camera

For **GV-LPC2210 / LPR2011**, see *Chapter 5 Installing the Target Bullet / LPR Camera* for installation instructions.

For **GV-LPC1200 / LPC2210**, see *Chapter 7 Installing the IP LPR Camera* for installation instructions.

Note for the Fisheye Camera with IR LED

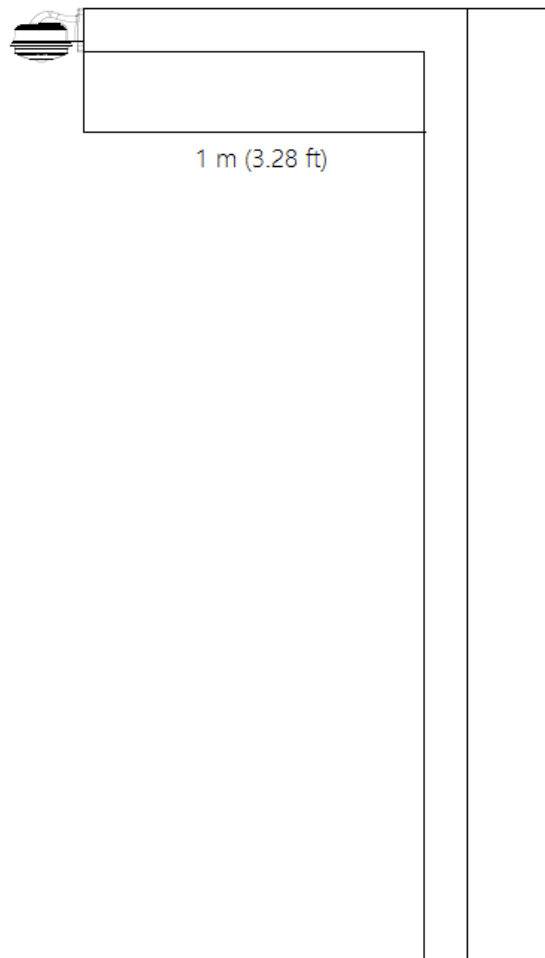

When installing **Mount 200 / 205 / 206 / 206-1** to your GV-FER / QFER Series with IR LED, leave a distance of 1 M (3.28 ft) or more between the camera body and the wall to avoid reflected glare by IR LED.



1. Introduction



1.1 Accessories List



Model No.	Name	Details
GV-Mount100	Straight Tube and Junction Box Kit 	Dimensions 200 x 170 x 257.5 mm / 7.9 x 6.7 x 10.1 in
		Weight 3.17 kg / 6.99 lb
GV-Mount101	Straight Tube Kit 	Dimensions 219 x 125 x 332 mm / 8.6 x 4.9 x 13.1 in
		Weight 1.8 kg / 3.97 lb
GV-Mount102	Straight Tube Box Mount 	Dimensions 256 x 256 x 316 mm / 10.1 x 10.1 x 12.4 in
		Weight 6.6 kg / 14.6 lb

Model No.	Name	Details
GV-Mount103 / 103-1	Straight Tube Mount 	Dimensions GV-Mount103 219 x 125 x 340 mm / 8.6 x 4.9 x 13.4 in GV-Mount103-1 219 x 125 x 240 mm / 8.6 x 4.9 x 9.4 in Weight GV-Mount103 2.2 kg / 4.9 lb GV-Mount103-1 1.76 kg / 3.88 lb
GV-Mount104 / 104-1		Dimensions 219 x 125 x 332 mm / 8.6 x 4.9 x 13.1 in Weight 1.8 kg / 3.97 lb
GV-Mount105 / 105-1		Dimensions 256 x 256 x 297 mm / 10.1 x 10.1 x 11.7 in Weight 6.2 kg / 13.67 lb

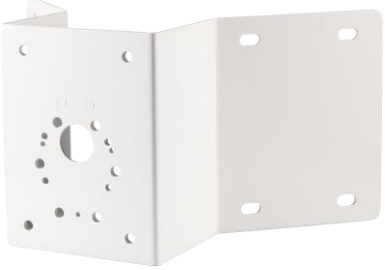
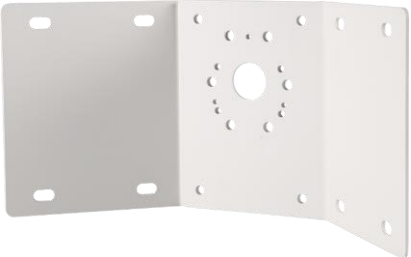

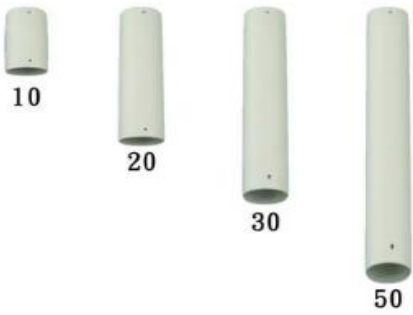

Model No.	Name	Details
GV-Mount200	Wall Pendant Mount 	Dimensions (L x W x D) 200 x 140 x 249 mm / 7.9 x 5.5 x 9.8 in
		Weight 0.93 kg / 2.05 lb
GV-Mount203	Wall Mount and Junction Box 	Dimensions 315 x 195.5 x 225 mm / 12.4 x 7.7 x 8.9 in
		Weight 2.95 kg / 6.5 lb
GV-Mount205	Wall Box Mount 	Dimensions Ø 160 x 126.5 x 203 mm / Ø 6.3 x 5 x 8 in
		Weight 0.5 kg / 1.1 lb
GV-Mount206 / 206-1	Wall Box Mount 	Dimensions Ø 176.85 x 126.5 x 211.3 mm / Ø 6.96 x 5 x 8.3 in
		Weight 0.93 kg / 2.06 lb
GV-Mount207	Wall Pendant Mount 	Dimensions 151.6 x 203.6 x 302.8 mm / 5.97 x 8.02 x 11.92"
		Weight 1.43 kg / 3.15 lb

Model No.	Name	Details
GV-Mount208-3 / 208-4	Swan Neck Mount 	Dimensions 1043 x 519 x 256 mm / 41.06 x 20.43 x 10.08" <hr/> Weight 10.6 kg / 23.37 lb

Model No.	Name	Details
GV-Mount210 / 210-1	Wall Pendant Mount 	Dimensions 200 x 140 x 249 mm / 7.9" x 5.5" x 9.80"
		Weight 1.1 kg / 2.43 lb
GV-Mount 300-1	Convex Corner Adapter Kit 	Dimensions 238.6 x 395.2 x 210 mm / 9.4 x 15.5 x 8.2 in
		Weight 4.27 kg / 9.41 lb
GV-Mount310-1	Concave Corner Adapter Kit 	Dimensions 111.2 x 369.9 x 210 mm / 4.37 x 14.5 x 8.2 in
		Weight 2.96 kg / 6.53 lb
GV-Mount 400-1	Pole Mount Bracket Kit (Ø4 ~ 6 in) 	Dimensions (Bracket) 68.4 x 240 x 163 mm / 2.69 x 9.44 x 6.41 in Steel Strap Diameter Ø4 ~ 6 in
		Weight 1.70 kg / 3.75 lb
GV-Mount410-1	Pole Mount Bracket Kit (Ø6 ~ 7.5 in) 	Dimensions (Bracket) 68.4 x 240 x 163 mm / 2.69 x 9.44 x 6.41 in Steel Strap Diameter Ø6 ~ 7.5 in
		Weight 1.70 kg / 3.75 lb

Model No.	Name	Details
GV-Mount501	Convex Corner Box Mount 	Dimensions 136 x 256 x 256 mm / 5.4 x 10.1 x 10.1 in Weight 4.8 kg / 10.6 lb
GV-Mount702	Extension Tube 	Four options are available. Dimensions Ø5.4 x 10 or 20 or 30 or 50 cm Ø2.1 x 3.9 / 7.9 / 11.8 / 19.7 in Weight 180 g / 0.4 lb 390 g / 0.86 lb 550 g / 1.21lb 800 g / 1.76 lb
GV-Mount902	GV-FD Series Dome Housing 	Dimensions Ø 86 x 165.35 mm / Ø7.3 x 6.51 in Weight 700 g / 1.54 lb

Model No.	Name	Details
GV-Mount903-1 / 903-2	GV-EFER Series Dome Housing 	Dimensions Ø185.51 x 165.35 mm / Ø 7.3 x 6.51 in Weight 900 g / 1.98 lb
GV-Mount904 / 904-1 / 904-2	Tilting Wall Mount Bracket 	Dimensions Ø159.1 x 40.5 mm / Ø 6.3 x 1.6 in Tilt angle: 0-20° Weight: 0.35 kg / 0.77 lb

Model No.	Name	Details
GV-Mount909	Wall Box Mount Bracket 	Dimensions 170 x 150 x 110 mm / 6.7 x 5.9 x 4.3 in
		Weight 610 g / 1.34 lb
GV-Mount910	Power Box Mount Bracket 	Dimensions 112 x 98 x 7.5 mm / 4.4 x 3.9 x 0.3 in
		Weight 105 g / 0.23 lb
GV-Mount912	Power Box Mount Bracket 	Dimensions Ø146 x 10.5 mm / 5.7 x 0.4 in
		Weight 180 g / 0.4 lb
GV-Mount912-1	Power Box Mount Bracket 	Dimensions Ø 130 mm / Ø 5.1 in
		Weight 180 g / 0.4 lb
GV-Mount913	Power Box Mount Bracket 	Dimensions Ø146 x 7.5 mm / 5.7 x 0.3 in
		Weight 180 g / 0.4 lb

Model No.	Name	Details
GV-Mount918	Wall Mount Bracket 	Dimensions 145 x 117 x 96 mm / 5.71 x 4.60 x 3.78 in Weight 350 g / 0.77 lb
GV-Housing 102	Housing Box 	Dimensions 406 x 145 x 109 mm / 16 x 5.7 x 4.3 in Weight 4.69 kg / 10.34 lb (Including Supporting Tube) Operation Ingress Protection (IP67) Vandal Resistance (IK10) Start-up Temperature: -30°C ~ 50°C / -22°F ~ 122°F Operation Temperature: -40°C ~ 50°C / -40°F ~ 122°F Heater: 15°C On / 25°C Off Fan: 35°C On / 25°C Off Power Board: 24V AC / 12V DC input
GV-Housing103	Housing Box 	Dimensions 404 x 128 x 257 mm / 15.91x 5.04 x 10.12 in Weight 7 kg / 15.43 lb Operation Ingress Protection (IP67) Vandal Resistance (IK10 for mental casing) Start-up Temperature: -20°C ~ 50°C / -4°F ~ 122°F Operation Temperature: -30°C ~ 50°C / -22°F ~ 122°F Power: 12V DC, 1A input

1.2 Dimensions

- **GV-Mount100** unit: mm

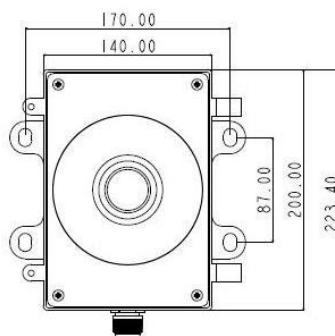
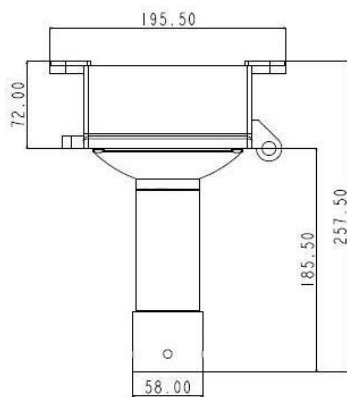
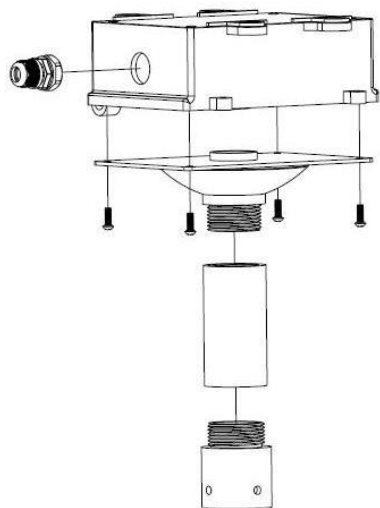

- **GV-Mount101** unit: mm

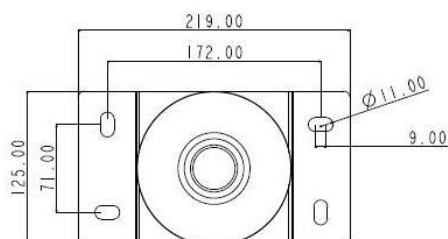
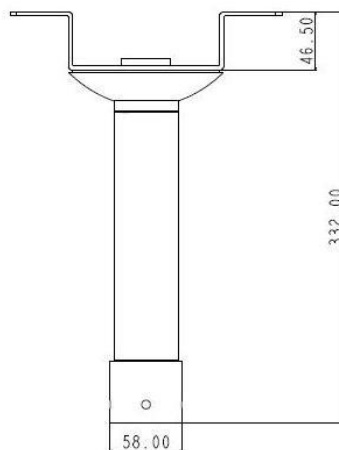
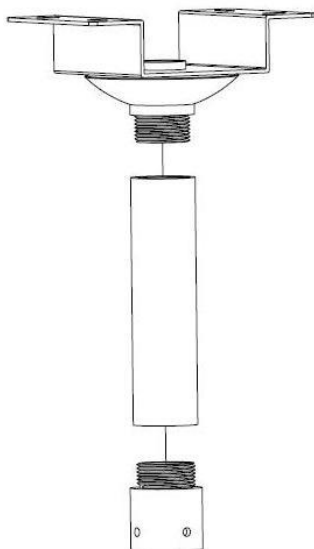

● GV-Mount102 unit: mm

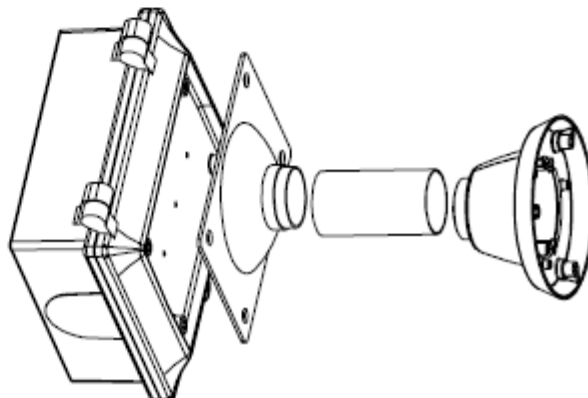
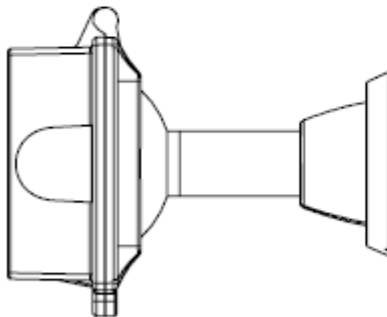
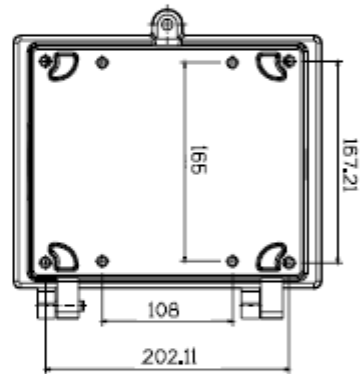
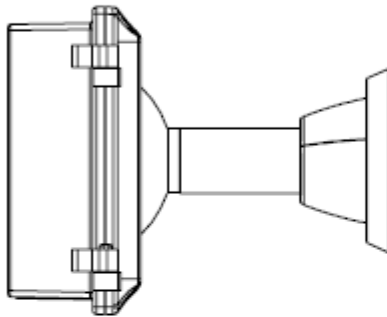
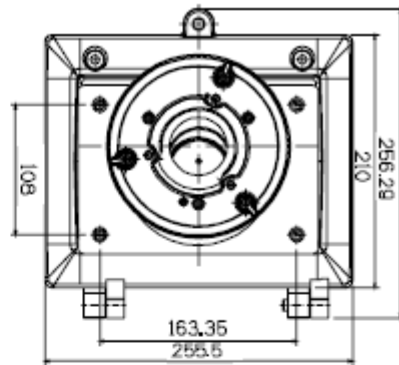
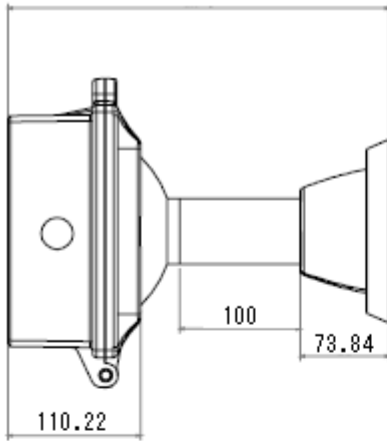

● **GV-Mount103 unit: mm**

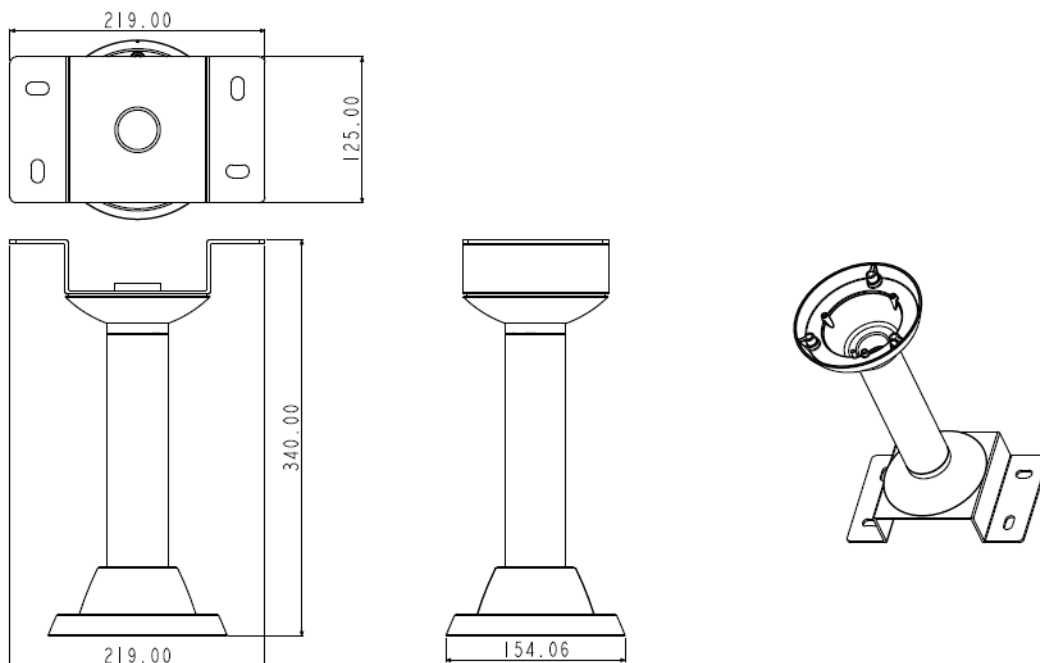

● **GV-Mount103-1 unit: mm**

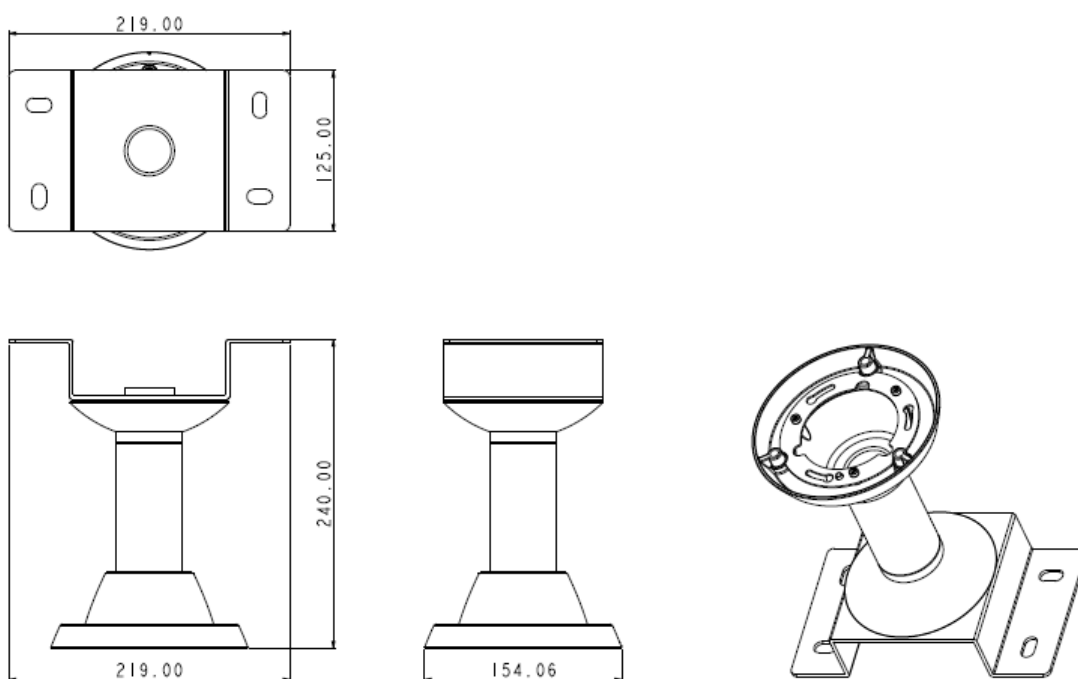

● GV-Mount104 / 104-1 unit: mm

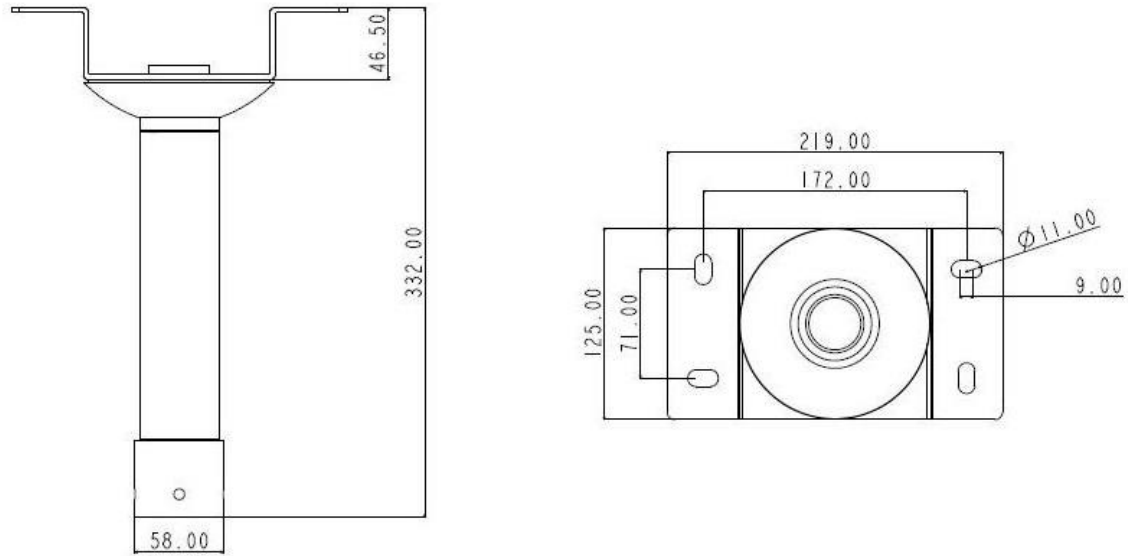

● GV-Mount105 / 105-1 unit: mm

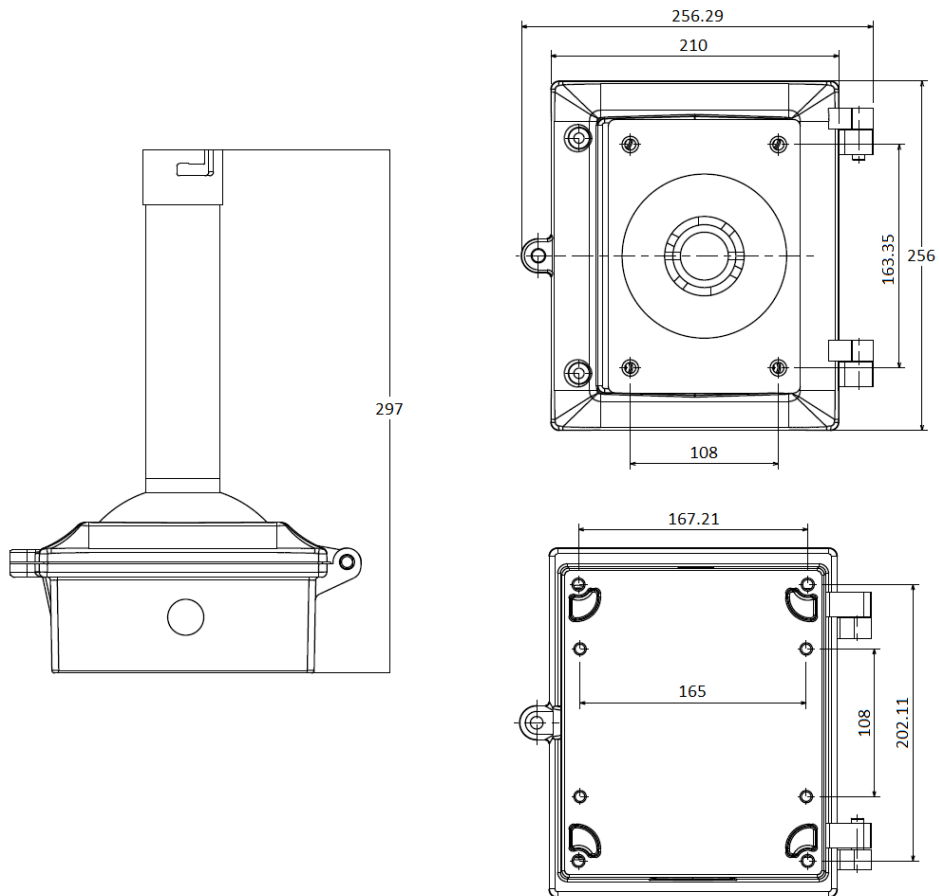

● **GV-Mount200 unit: mm**

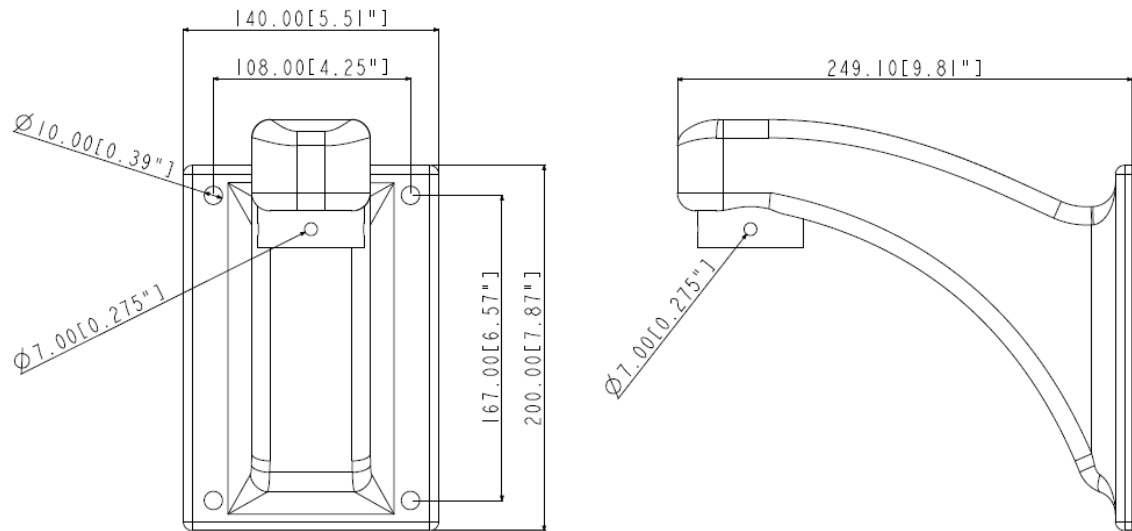

● **GV-Mount203 unit: mm**

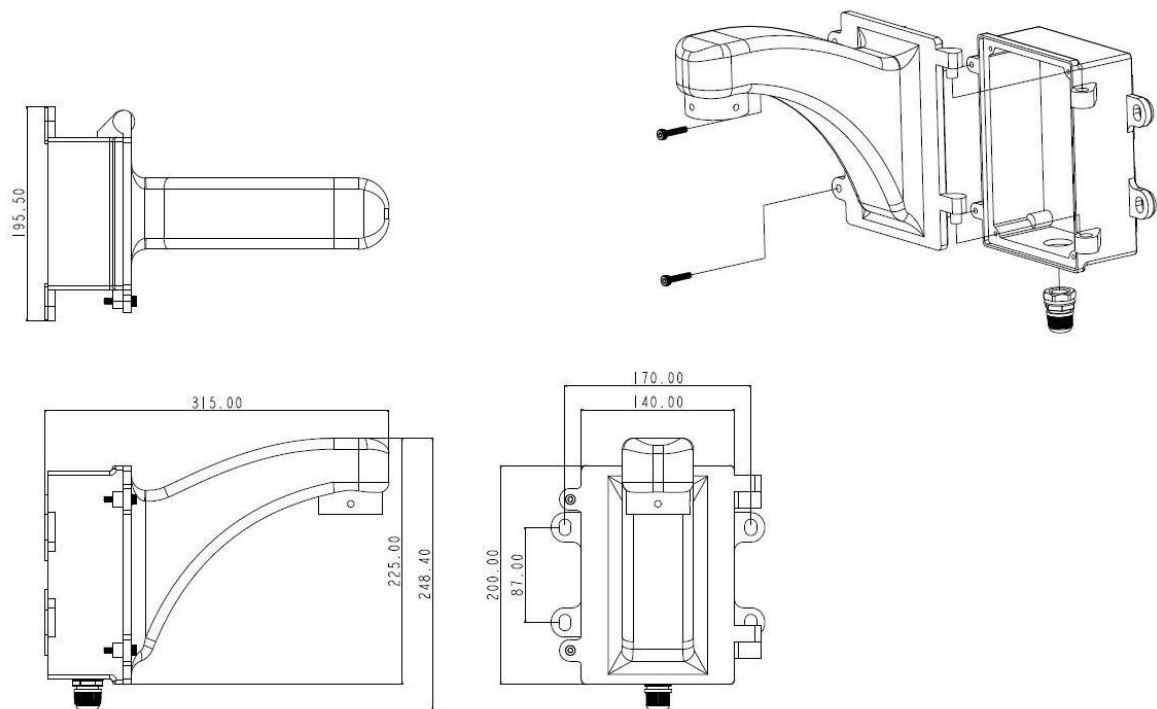

● GV-Mount205 unit: mm

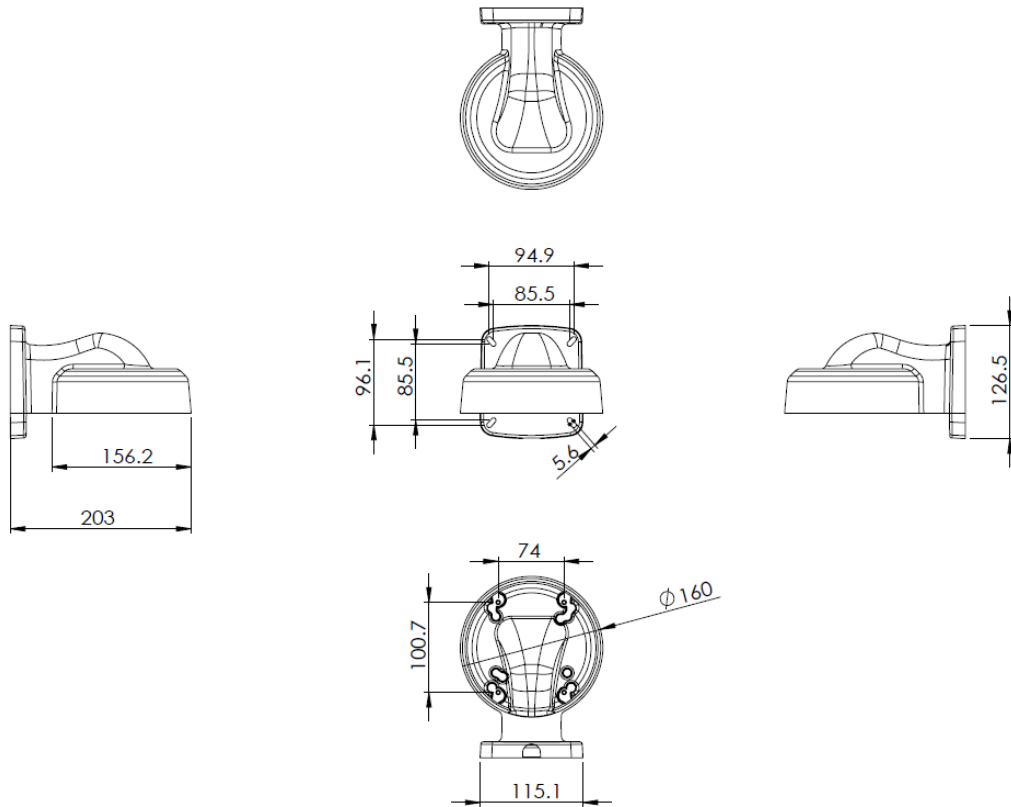

● GV-Mount206 / 206-1 unit: mm

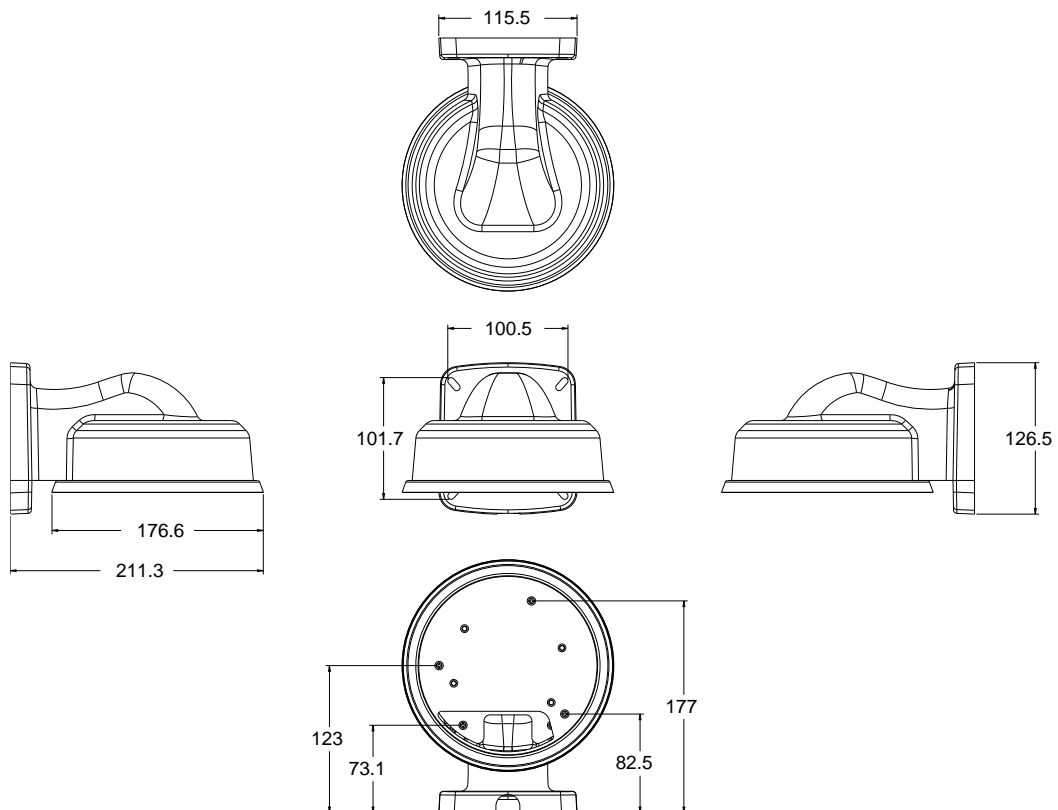

● **GV-Mount207**

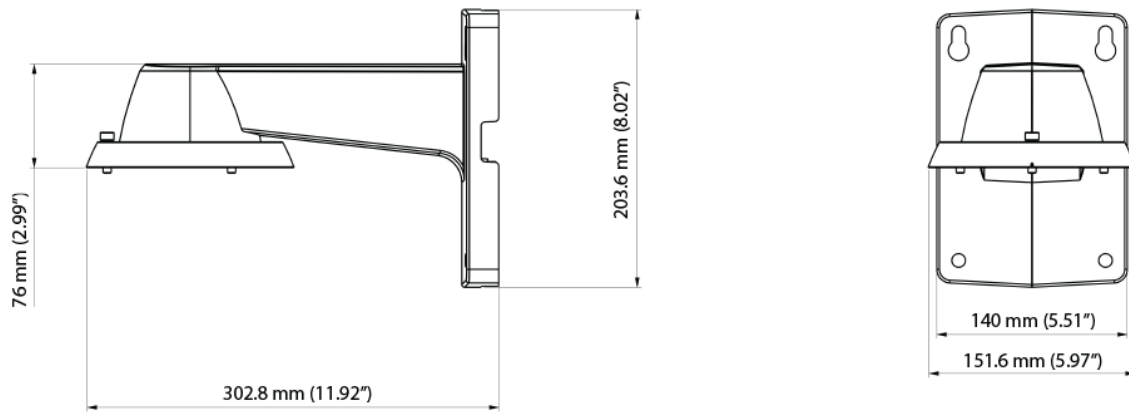

● **GV-Mount208-1 unit: mm**

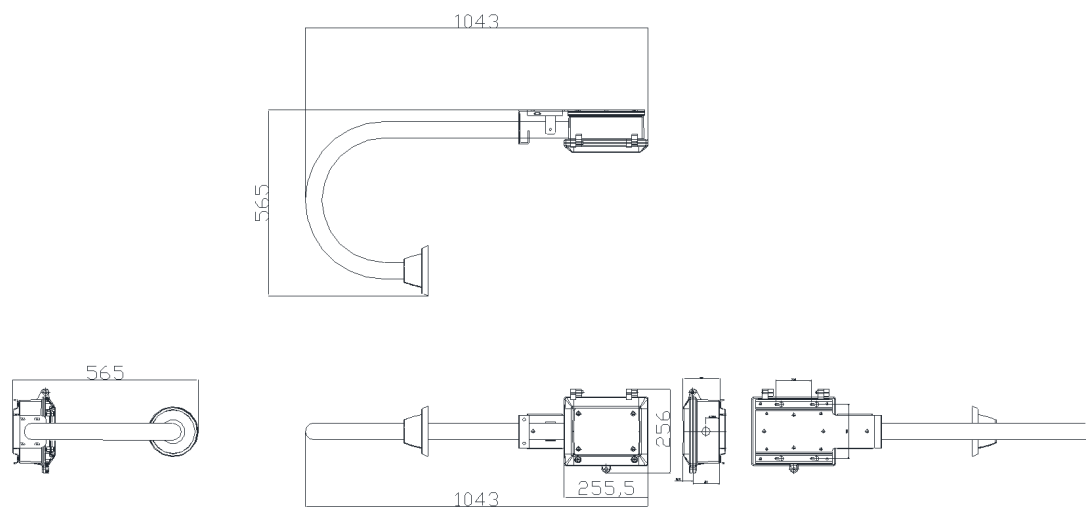

● **GV-Mount208-2 unit: mm**

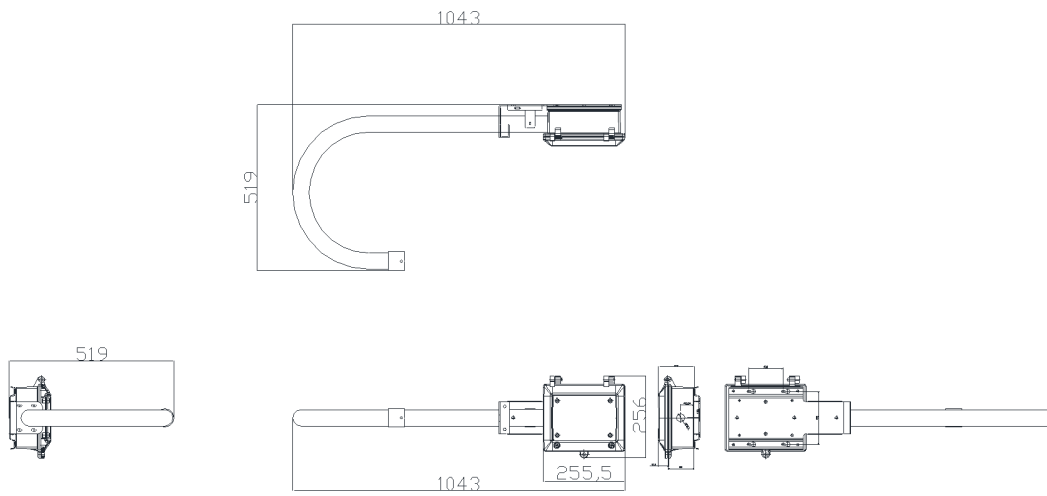

● **GV-Mount208-3 / 208-4 unit: mm**

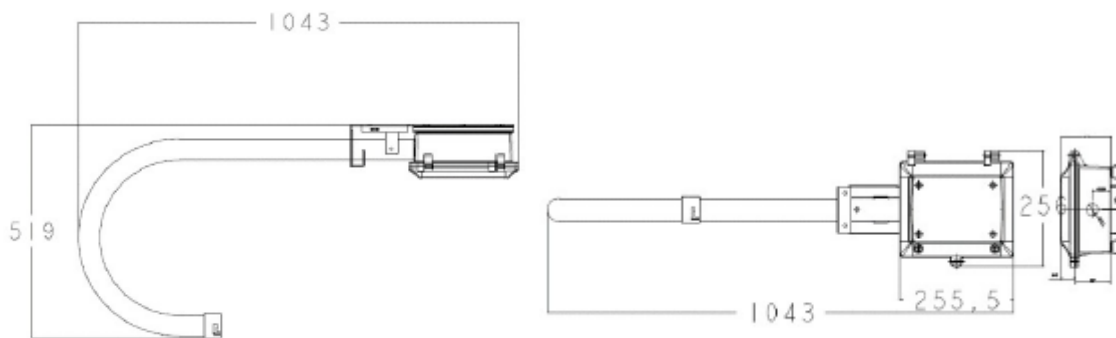

● **GV-Mount210 / 210-1 unit: mm**

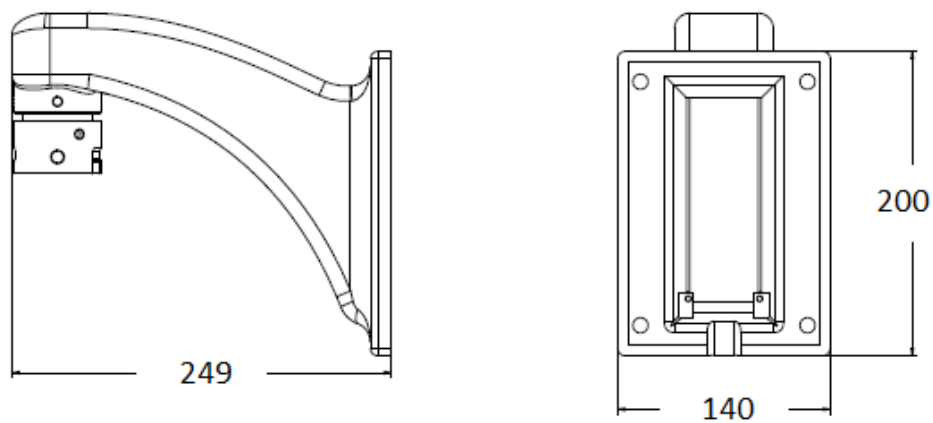

● **GV-Mount300-1**

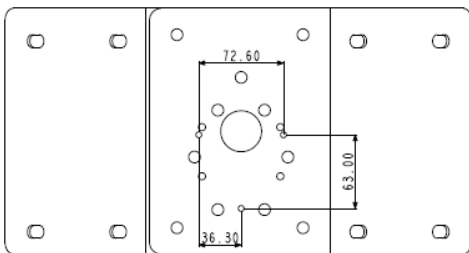
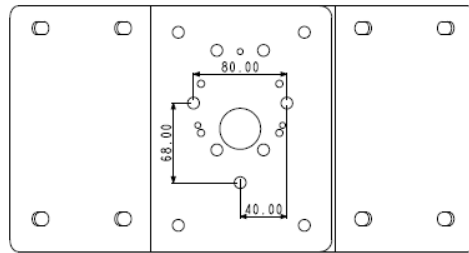
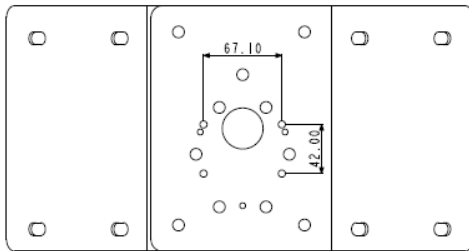
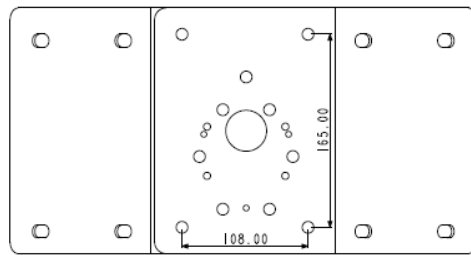
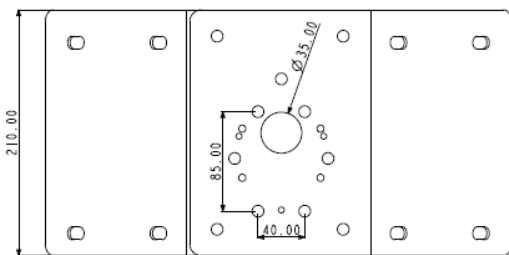
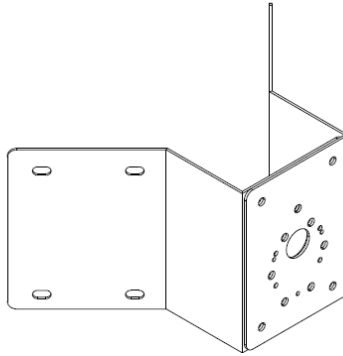
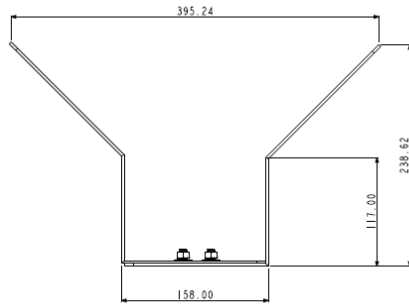

GV-Housing103

● GV-Mount310-1 unit: mm

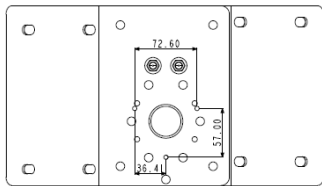
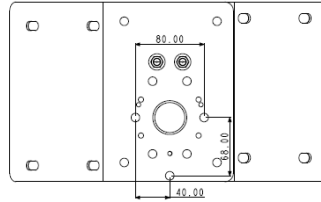
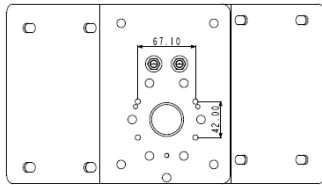
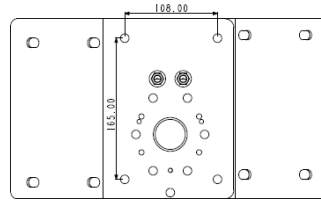
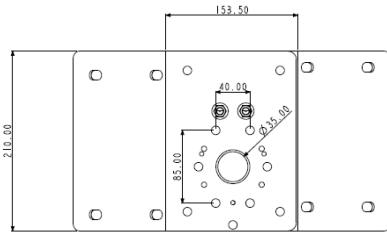
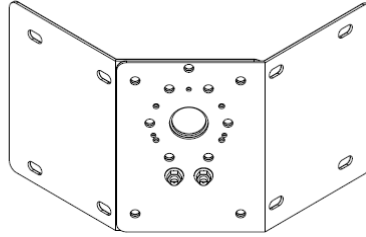
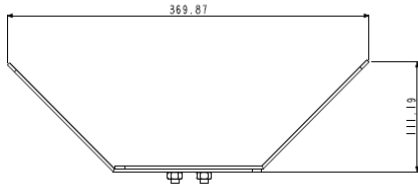

● **GV-Mount400-1 / GV-Mount410-1 unit: mm**

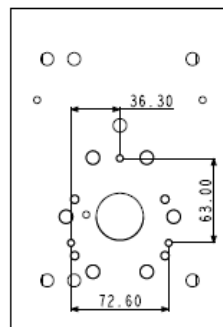
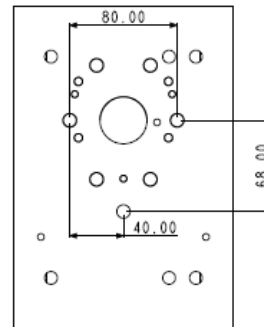
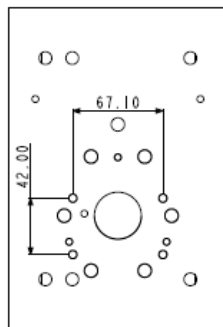
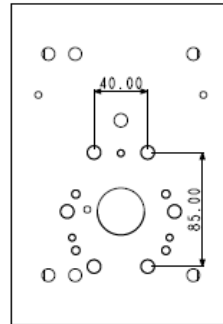
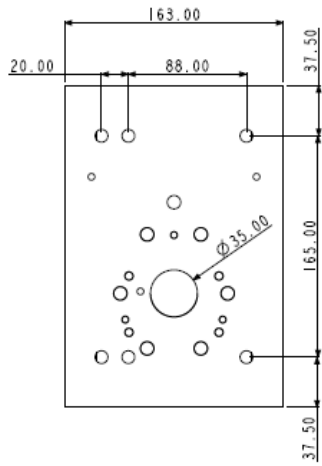
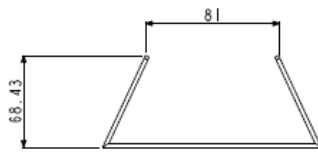

- GV-Mount501 unit: mm

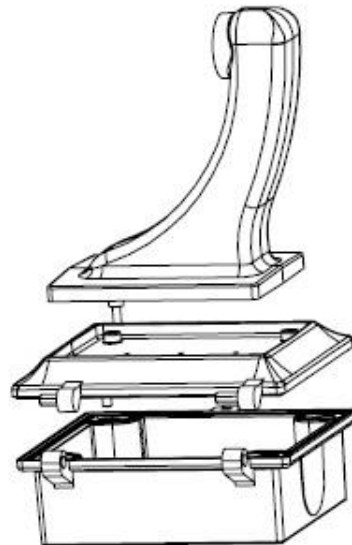
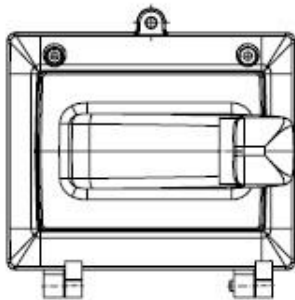
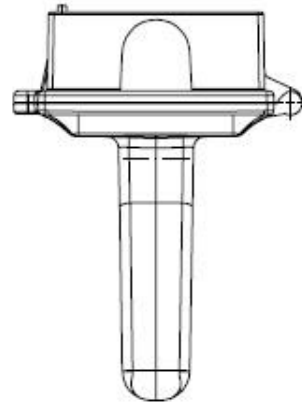
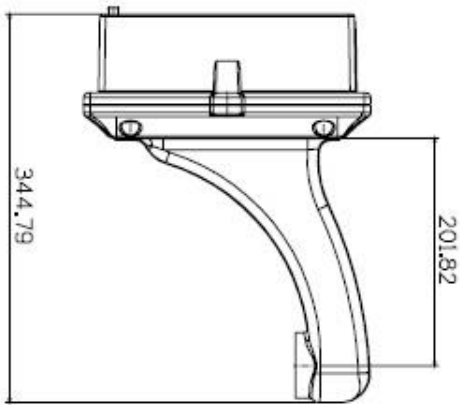
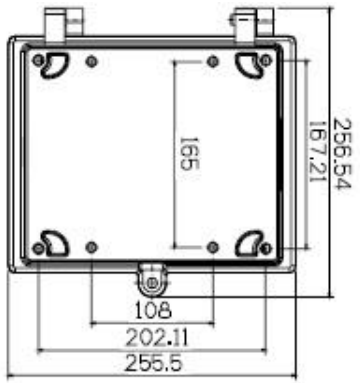

● **Mount902 / Mount903-1 / Mount903-2 / Mount917** unit: mm

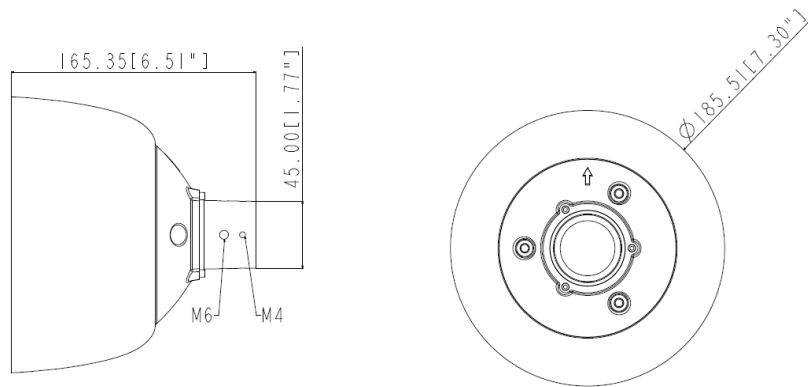

● **GV-Mount904-1 / 904-2**

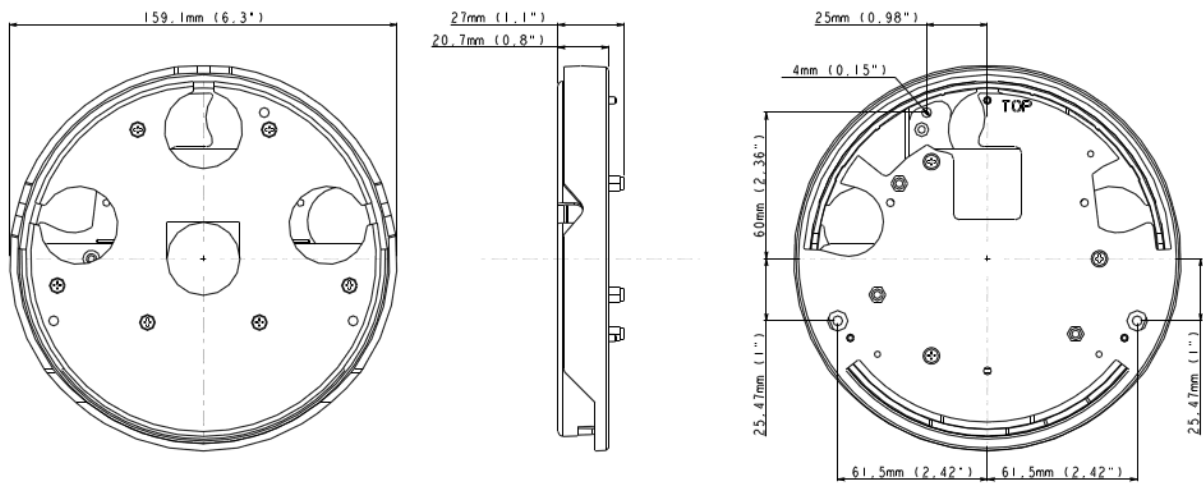

● GV-Mount909

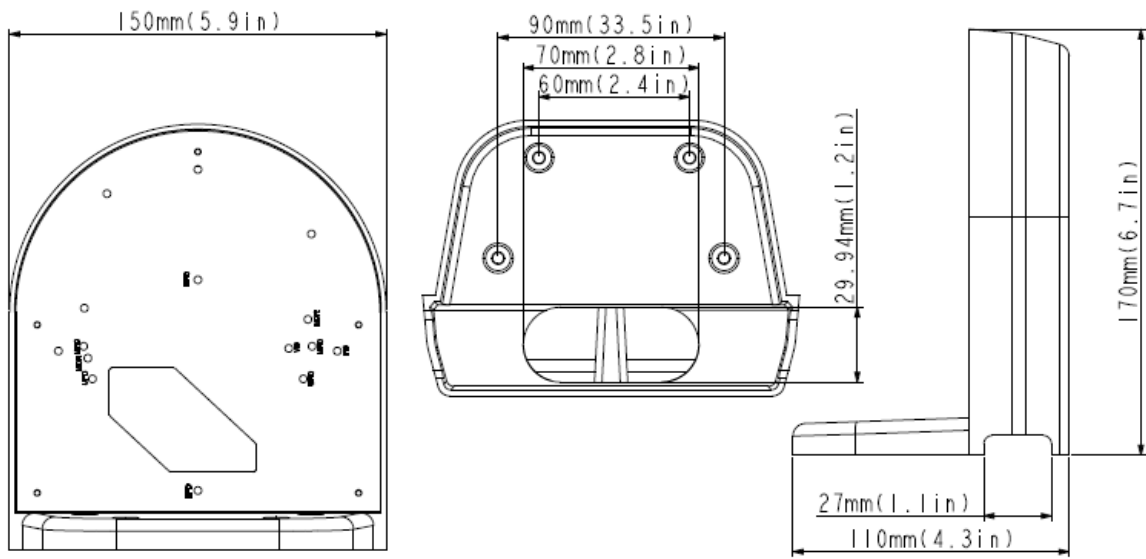

● **GV-Mount910**

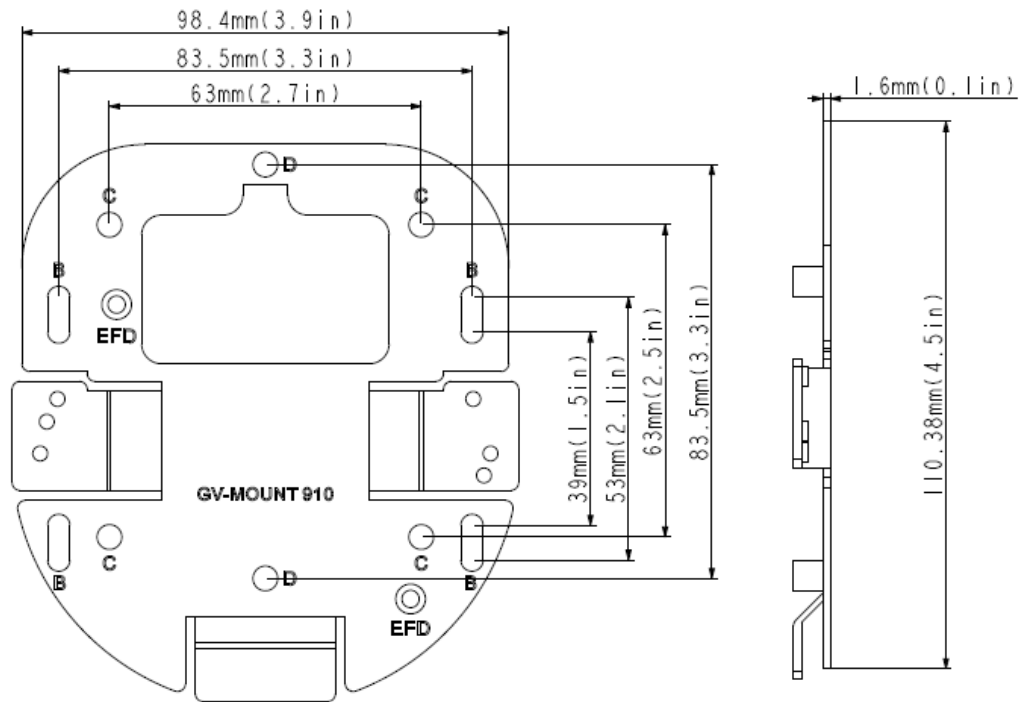

● **GV-Mount912**

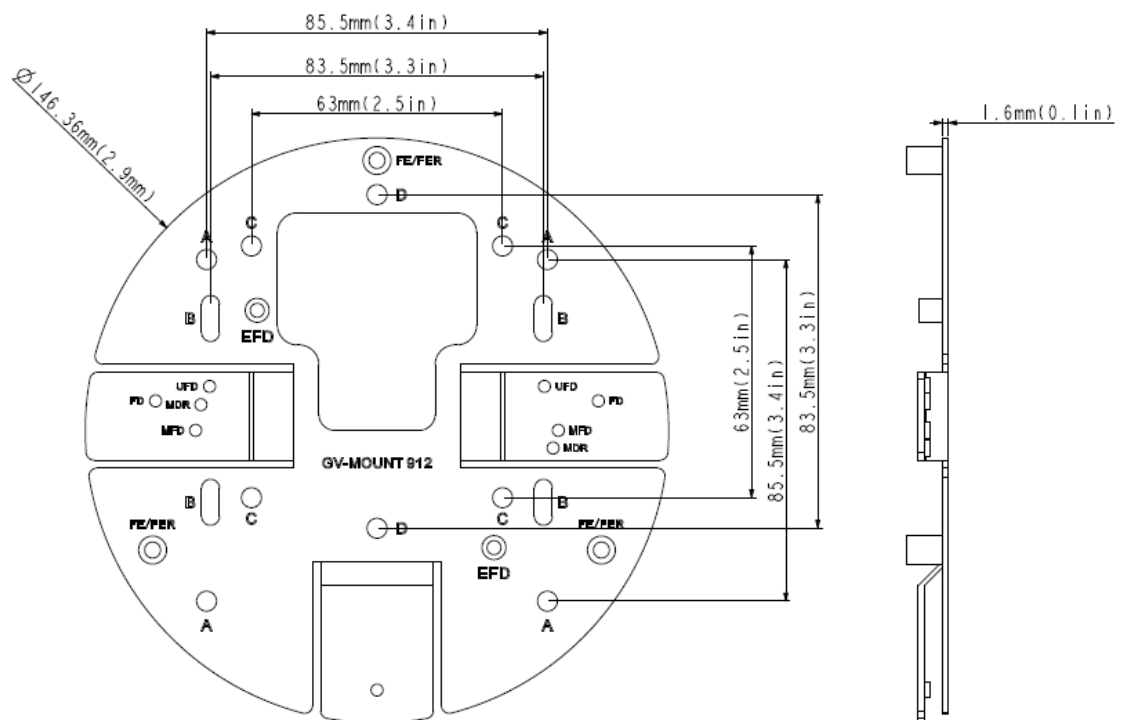

● GV-Mount912-1

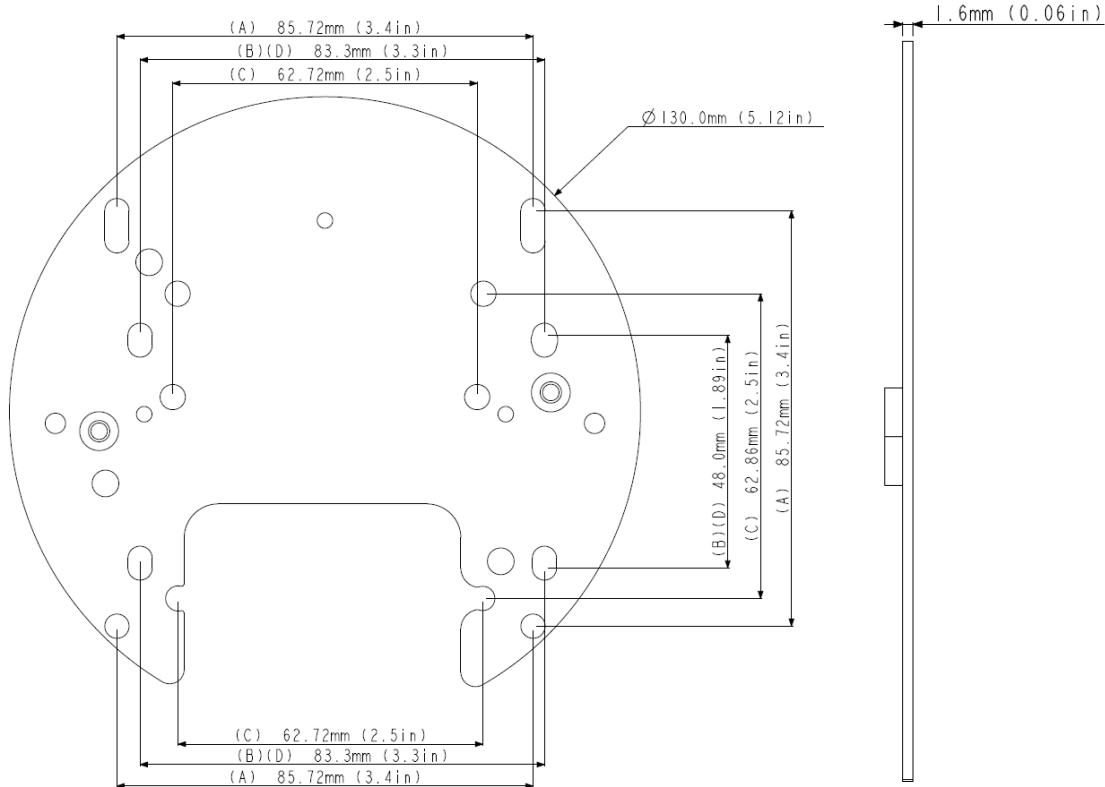

● GV-Mount913

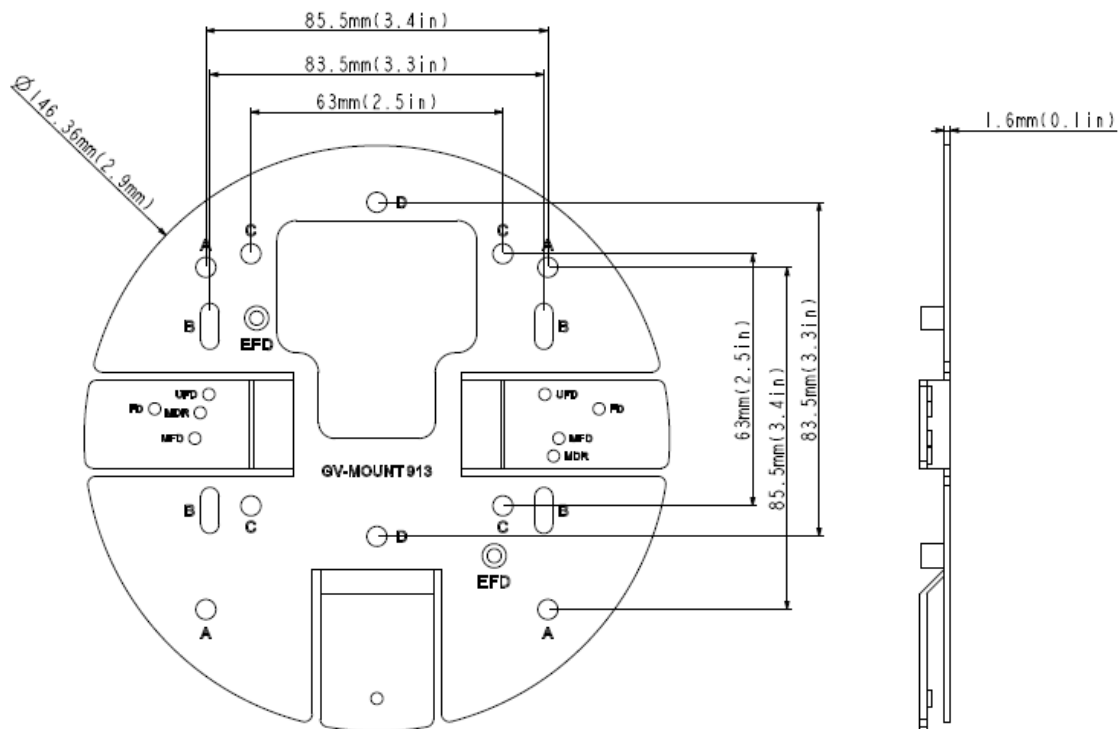

•

● **GV-Mount915**

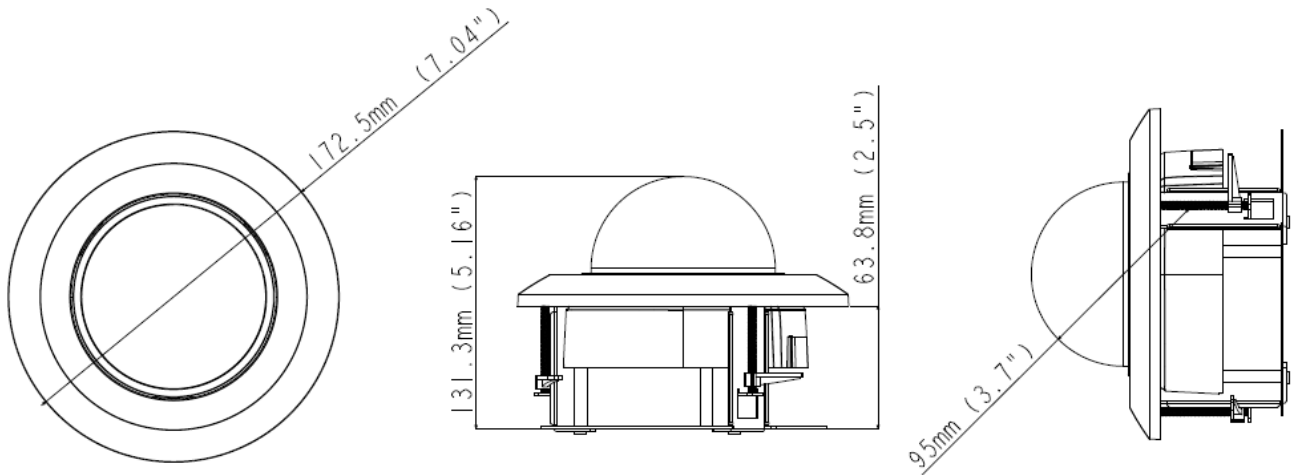

● **GV-Mount916**

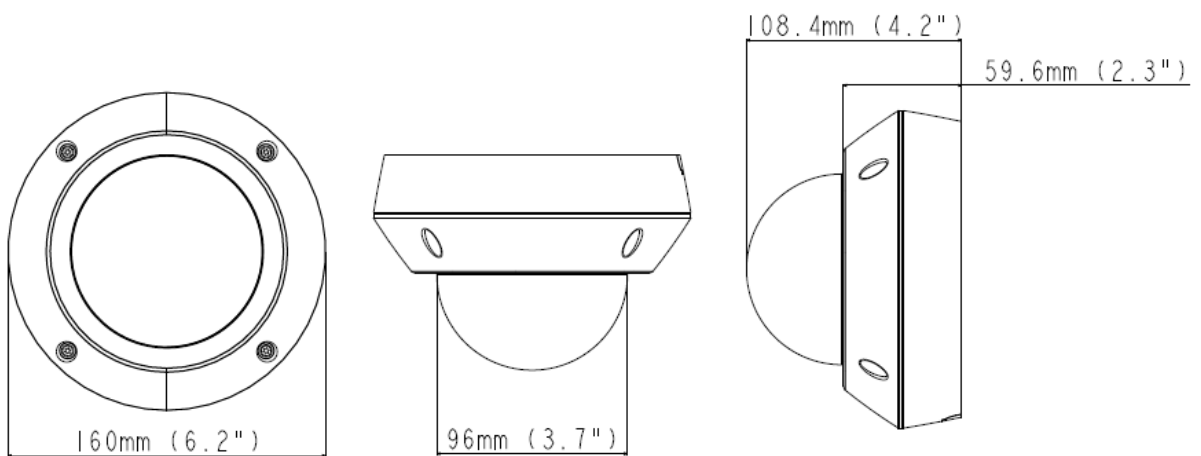

● GV-Mount918

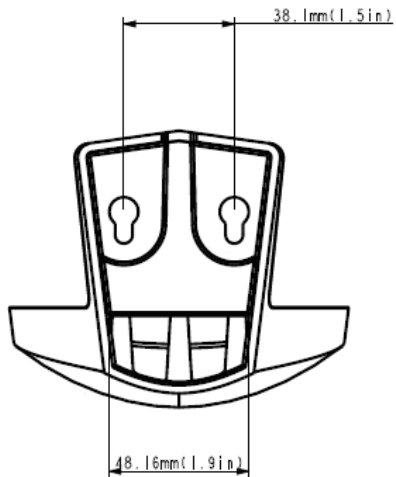
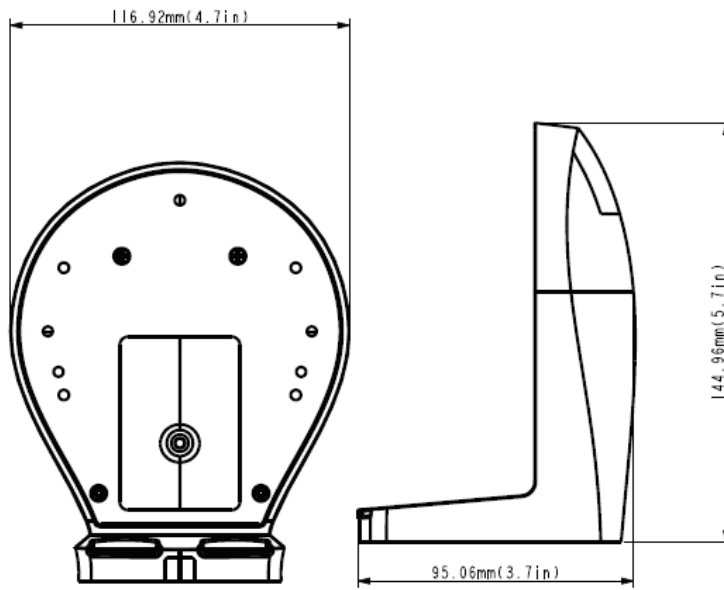

- **GV-Housing102**

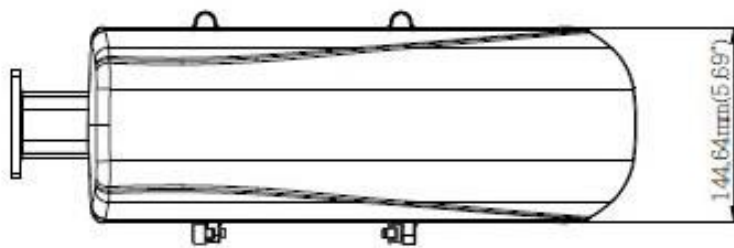
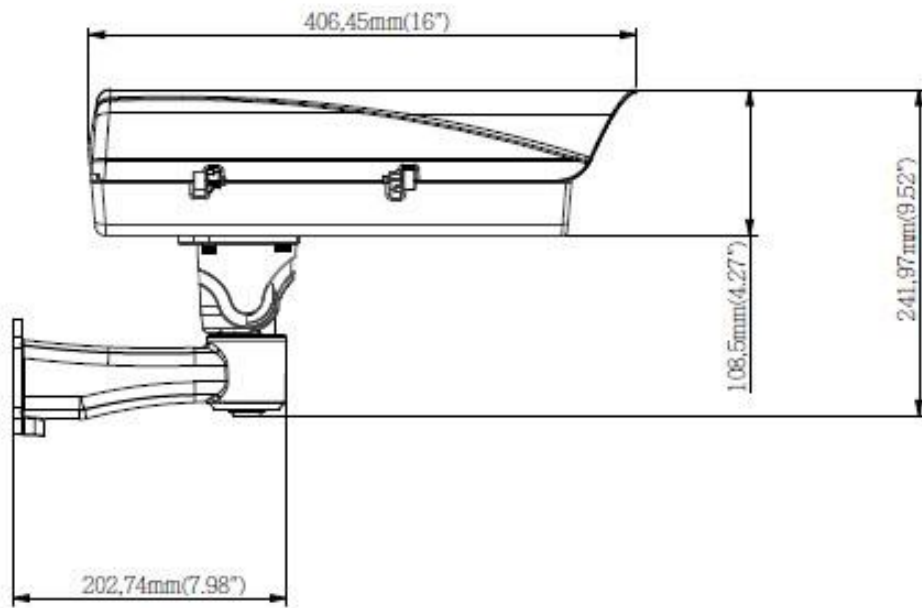

Supporting Tube

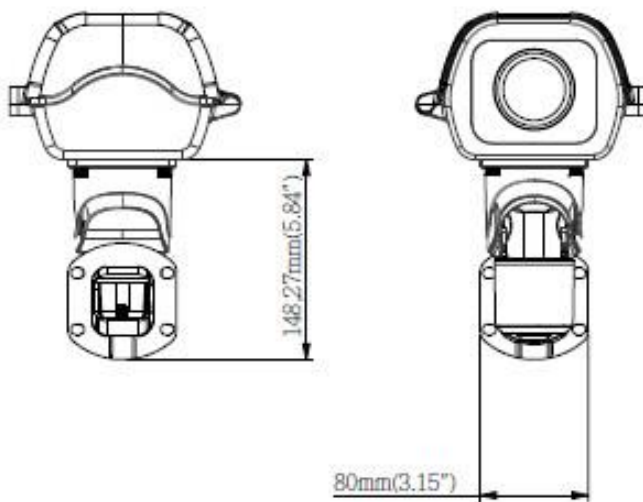



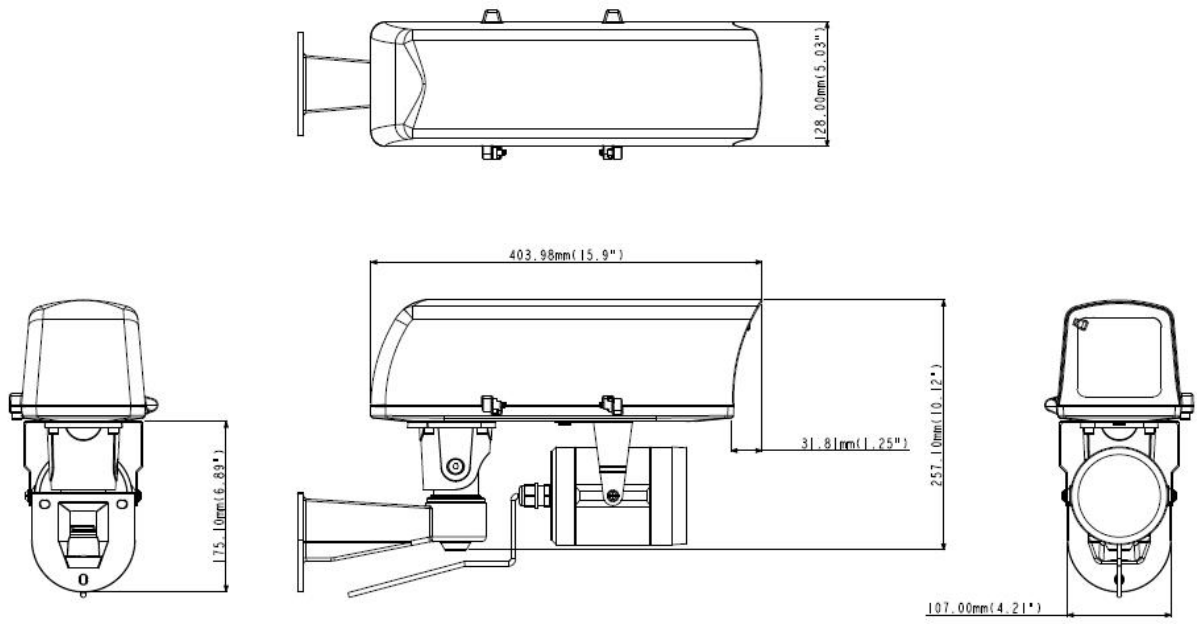



● GV-Housing103







1.3 Packing Lists

- **GV-Mount100**

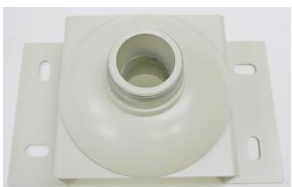
<p>1. Junction Box</p> 	<p>2. Box Cover</p> 
<p>3. Tube</p> 	<p>4. Tube Connector</p> 
<p>5. M5 Flat Screw x 4</p> 	<p>6. Corrugated Tube Connector</p> 
<p>7. No. 2 Hex Key</p> 	





- **GV-Mount101**

<p>1. Mounting Bracket</p> 	<p>2. Tube</p> 
<p>3. Tube Connector</p> 	<p>4. No. 2 Hex Key</p> 







● GV-Mount102

<p>1. Junction Box</p>  A square metal junction box with a dark interior and four mounting tabs on the sides.	<p>2. Box Cover</p>  A square metal box cover with a central circular hole and four mounting tabs on the sides.
<p>3. Supporting Plate</p>  A rectangular metal supporting plate with four mounting holes and a central slot.	<p>4. Box Cover Plate</p>  A square metal box cover plate with a central threaded hole and four mounting holes.
<p>5. Mounting Cap</p>  A white plastic mounting cap with a central threaded hole and four mounting holes.	<p>6. Tube</p>  A white plastic tube with a threaded end.
<p>7. No. 5 Hex Key</p>  A silver metal hex key (Allen key).	<p>8. No. 2 Hex Key</p>  A silver metal hex key (Allen key).
<p>9. No. 6 Hex Key</p>  A silver metal hex key (Allen key).	<p>10. M8 (16 mm) Screw x 4</p>  Four silver metal screws.
<p>11. M8 (20 mm) Screw x 4</p>  Four silver metal screws.	<p>12. Waterproof Rubber</p>  A circular black waterproof rubber seal with three holes.













● **GV-Mount103 / 103-1**

<p>1. Mounting Bracket</p> 	<p>2. Mounting Cap</p> 
<p>3. Tube</p> 	<p>4. No. 2 Hex Key</p> 

● **GV-Mount104 / 104-1**

<p>1. Mounting Bracket</p> 	<p>2. Connecting Tube</p>  <p>GV-Mount104 GV-Mount104-1</p>
<p>3. Tube</p> 	<p>4. No. 2 Hex Key</p> 
<p>5. Screw x 2</p> 	<p>6. Anti-drop Safety Ring</p> 

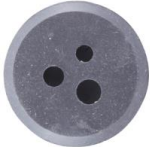
● GV-Mount105 / 105-1

<p>1. Junction Box</p> 	<p>2. Box Cover</p> 
<p>3. Supporting Plate</p> 	<p>4. Box Cover Plate</p> 
<p>5. Connecting Tube</p>  <p>GV-Mount105 GV-Mount105-1</p>	<p>6. Tube</p> 
<p>7. No. 5 Hex Key</p> 	<p>8. No. 2 Hex Key</p> 
<p>9. No. 6 Hex Key</p> 	<p>10. M8 (16 mm) Screw x 4</p> 
<p>11. M8 (20 mm) Screw x 4</p> 	<p>12. Waterproof Rubber A</p> 
<p>13. Waterproof Rubber B</p> 	<p>14. Screw x 2</p> 

<p>15. Anti-Drop Safety Ring</p> 	
--	--









● **GV-Mount200**

<p>1. Wall Pendant Mount</p> 	
--	--

● **GV-Mount203**

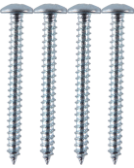









<p>1. Junction Box</p> 	<p>2. Wall Pendant Mount</p> 
<p>3. M5 Screw x 2</p> 	<p>4. Corrugated Tube Connector</p> 
<p>5. No.5 Hex Key</p> 	

● GV-Mount205

<p>Wall Box Mount</p> 	<p>1. Mounting Plate</p> 
<p>2. Housing Plate</p> 	<p>3. M4 Screw (8 mm) x 15</p> 
<p>4. M4 Screw (40 mm) x 4</p> 	<p>5. Screw Anchor x 4</p> 
<p>6. M4.5 Plain Washer x 4</p> 	<p>7. M4 Split Washer x 4</p> 

Note: Installation of GV-Mount205 does not require all 15 M4 screws (8 mm) to be used. GV-FD Series and GV-FE Series need 10 M4 screws, while GV-VD Series need 11 M4 screws for installation. The GV-VD Series that GV-Mount205 can be applied to are GV-VD120D / 121D / 122D / 123D / 220D / 221D / 222D / 223D / 320D / 321D / 322D / 323D / 1500 / 2400 / 2500 / 3400.

● **GV-Mount206 / 206-1**

<p>1. Wall Box Mount</p> 	<p>2. Mounting Plate</p> 
<p>3. Housing Plate</p> 	<p>4. M4 Screw (8 mm) x 15</p> 
<p>5. M4 Screw (40 mm) x 4</p> 	<p>6. Screw Anchor x 4</p> 
<p>7. M4.5 Plain Washer x 4</p> 	<p>8. M4 Split Washer x 4</p> 
<p>9. GV-Mount912-1 (For GV-Mount206-1)</p> 	<p>10. M4 Screw (18 mm) x 2 (For GV-Mount206-1)</p> 

Note: Installation of GV-Mount206 / 206-1 does not require all 15 M4 screws (8 mm) to be used. Only 11 M4 screws are needed for installation. The GV-VD Series that GV-Mount205 can be applied to are GV-VD1530 / 1540 / 1540-E / 2430 / 2440 / 2440-E / 2530 / 2540 / 2540-E / 3430 / 3440 / 3440-E / 5340 / 5340-E.

- **GV-Mount207**

1. Wall Pendant Mount











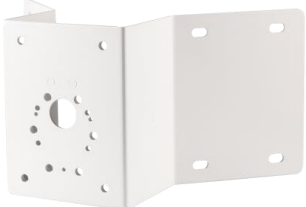

GV-Mount208-3 / 208-4

<p>2. No. 2 Hex Key</p> 	<p>3. No.3 Hex Key</p> 
<p>4. No. 5 Hex Key</p> 	<p>5. No. 6 Hex Key</p> 
<p>6. Swan Neck Stainless Tube</p> 	<p>7. Junction Box</p> 
<p>8. Screw x 2</p> 	<p>9. Connecting Tube</p>  <p>GV-Mount208-3 GV-Mount208-4</p>
<p>10. Anti-drop Safety Ring</p> 	











● **GV-Mount210 / 210-1**

<p>1. Wall Pendant Tube</p> 	<p>2. Screw x 2</p> 
<p>3. M5 Hex Key</p> 	<p>4. Connecting Tube</p>  <p>GV-Mount210 GV-Mount210-1</p>

● **GV-Mount300-1**

<p>1. Mounting Plate x 2</p> 	<p>2. M8 Screw (30 mm) x 4</p> 
<p>3. M8 Screw (25 mm) x 4</p> 	<p>4. M8 Plain Washer x 6</p> 
<p>5. M8 Split Washer x 6</p> 	<p>6. M8 Screw Cap x 6</p> 
<p>7. M5 Screw (20 mm) x 4</p> 	<p>8. M5 Plain Washer x 4</p> 
<p>9. M5 Split Washer x 4</p> 	<p>10. M5 Screw Cap x 4</p> 
<p>11. M8 Screw (45 mm) x 4 for GV SD2301 / 2301 V2 / 2411 / 2411 V2 / 2723-IR / 2733-IR</p> 	













● **GV-Mount310-1**

<p>1. Mounting Plate x 2</p> 	<p>2. M8 Screw (30 mm) x 4</p> 
<p>3. M8 Screw (25 mm) x 4</p> 	<p>4. M8 Plain Washer x 6</p> 
<p>5. M8 Split Washer x 6</p> 	<p>6. M8 Screw Cap x 6</p> 
<p>7. M5 Screw (20 mm) x 4</p> 	<p>8. M5 Plain Washer x 4</p> 
<p>9. M5 Split Washer x 4</p> 	<p>10. M5 Screw Cap x 4</p> 
<p>11. M8 Screw (45 mm) x 4 for GV-SD2301 / 2301 V2 / 2411 / 2411 V2 / 2723-IR / 2733-IR</p> 	









● **GV-Mount400-1**

<p>1. Mounting Bracket</p> 	<p>2. Stainless Steel Strap (Ø4 ~ 6 in) x 3</p> 
<p>3. M8 Screw (30 mm) x 4</p> 	<p>4. M8 Screw (25 mm) x 4</p> 
<p>5. M8 Plain Washer x 4</p> 	<p>6. M8 Split Washer x 4</p> 
<p>7. M8 Screw Cap x 4</p> 	<p>8. M5 Screw (20 mm) x 4</p> 
<p>9. M5 Plain Washer x 4</p> 	<p>10. M5 Split Washer x 4</p> 
<p>11. M5 Screw Cap x 4</p> 	<p>12. M8 Screw (45 mm) x 4 for GV-SD2301 / 2301 V2 / 2411 / 2411 V2 / 2723-IR / 2733-IR</p> 

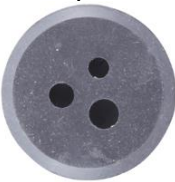

● **GV-Mount410-1**

<p>1. Mounting Bracket</p> 	<p>2. Stainless Steel Strap (Ø6 ~ 7.5 in) x 3</p> 
<p>3. M8 Screw (30 mm) x 4</p> 	<p>4. M8 Screw (25 mm) x 4</p> 
<p>5. M8 Plain Washer x 4</p> 	<p>6. M8 Split Washer x 4</p> 
<p>7. M8 Screw Cap x 4</p> 	<p>8. M5 Screw (20 mm) x 4</p> 
<p>9. M5 Plain Washer x 4</p> 	<p>10. M5 Split Washer x 4</p> 
<p>11. M5 Screw Cap x 4</p> 	<p>12. M8 Screw (45 mm) x 4 for GV-SD2301 / 2301 V2 / 2411 / 2411 V2 / 2723-IR / 2733-IR</p> 

● **GV-Mount501**

<p>1. Junction Box</p> 	<p>2. Box Cover</p> 
<p>3. Supporting Plate</p> 	<p>4. M8 (30 mm) Screw x 4</p> 
<p>5. M8 (20 mm) Screw x 8</p> 	<p>6. Waterproof Rubber A</p> 
<p>7. No. 5 Hex Key</p> 	<p>8. No. 6 Hex Key</p> 
<p>9. Plain washer</p> 	<p>10. Waterproof Rubber B</p> 

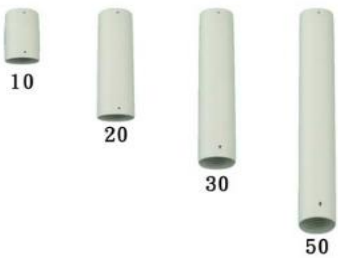
● **GV-Mount702**

<p>1. Extension Tube</p> 	<p>2. Extension Tube Connector</p> 
--	--





● **GV-Mount902**

<p>1. Dome Housing</p> 	<p>2. Housing Cap</p> 
<p>3. M4 Screw x 8</p> 	<p>4. M6 Screw x 7</p> 
<p>5. Left and Right Rack</p> 	<p>6. Housing Plate</p> 
<p>7. Small Screw x 5</p> 	

● **GV-Mount903-1 / 903-2**

<p>1. Dome Housing</p> 	<p>2. Housing Cap</p> 
<p>3. M4 Screw x 4</p> 	<p>4. M6 Screw x 7</p> 
<p>5. M3 Screw x 3</p> 	<p>6. Flat M4 Screw x 3</p> 
<p>7. Housing Plate</p> 	<p>8. GV-Mount912-1 (For GV-Mount903-2)</p> 
<p>9. M4 Screw (18 mm) x 2 (For GV-Mount903-2)</p> 	







● **GV-Mount904**

<p>1. Back Cover</p> 	<p>2. Back Plate</p> 
<p>3. Tilting Rack</p> 	<p>4. Long Screw x 3</p> 
<p>5. Short Screw x 9</p> 	
<p>6. Installation Sticker</p>	





● **GV-Mount904-1 / 904-2**

<p>1. GV-Mount904-1</p> 	<p>2. Hex Key</p> 
<p>3. Screw Anchor x 3</p> 	<p>4. Wall Mount Screw x 3</p> 
<p>5. M3 Screw x 3</p> 	<p>6. Installation Sticker</p>
<p>7. GV-Mount912-1 (For GV-Mount904-2)</p> 	<p>8. M4 Screw (18 mm) x 2 (For GV-Mount904-2)</p> 



● **GV-Mount907**

<p>1. Support Rack x 3</p> 	<p>2. Mounting Ring</p> 
<p>3. Screw x 9</p> 	<p>4. Thread Lock, Screw, Washer</p> 
<p>5. Mounting Plate</p> 	<p>6. Hex Key</p> 
<p>7. Lock Plate and Screw</p> 	<p>8. Installation Sticker</p>
<p>9. In-Ceiling Cover</p> 	



● **GV-Mount909**

<p>1. Wall Bracket</p> 	<p>2. Screw Anchor x 4</p> 
<p>3. Wall Mount Screw x 4</p> 	<p>4. M3 Screw (8 mm) x 4</p>  <p>* For GV-FD Series, GV-MFD Series, GV-MDR Series, GV-EFD Series, and GV-EDR Series</p>
<p>5. M5 Screw (10 mm) x 6</p> 	

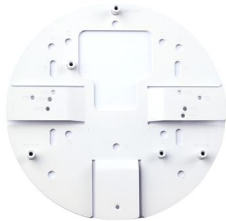

- **GV-Mount910**

<p>6. Mounting Plate</p> 	<p>7. M3 Screw (8 mm) x 4</p> 
--	---



- **GV-Mount912**

<p>1. Mounting Plate</p> 	<p>2. M3 Screw (8 mm) x 4</p> 
--	---

- **GV-Mount912-1**







<p>1. GV-Mount912-1</p> 	<p>2. M3 Screw (8 mm) x 4</p> 
<p>3. M4 Screw (18 mm) x 2</p> 	

- **GV-Mount913**







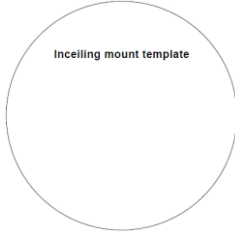

<p>1. Mounting Plate</p> 	<p>2. M3 Screw (8 mm) x 4</p> 
--	---

-
-

● **GV-Mount915**

<p>1. Bracket x 3</p> 	<p>2. In-Ceiling Plate</p> 
<p>3. In-Ceiling Cover</p> 	<p>4. In-Ceiling Ring</p> 
<p>5. M3 Black Screw x 9</p> 	<p>6. M3 Screw (6 mm) x 3</p> 
<p>7. M3 Short Screw (3 mm) x 2</p> 	<p>8. Installation Sticker</p> 
<p>9. Thread Lock</p>	





● **GV-Mount916**

<p>1. Bracket x 3</p> 	<p>2. In-Ceiling Plate</p> 
<p>3. In-Ceiling Cover</p> 	<p>4. In-Ceiling Ring</p> 
<p>5. M3 Black Screw x 9</p> 	<p>6. M4 Screw x 4</p> 
<p>7. M3 Short Screw x 2</p> 	<p>8. Installation Sticker</p> 
<p>9. Thread Lock</p>	

● **GV-Mount917**

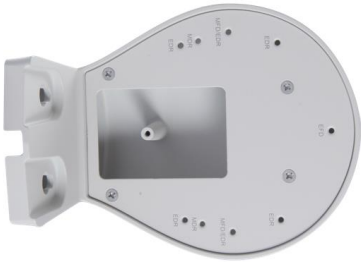
<p>1. Dome Housing</p> 	<p>2. Housing Cap</p> 
<p>3. M4 Small Screw x 7</p> 	<p>4. M6 Screw x 7</p> 
<p>5. Housing Plate</p> 	

● **GV-Mount918**

<p>1. Wall Mount Bracket</p> 	<p>2. Screw Anchor x 2</p> 
<p>3. Wall Mount Screw x 2</p> 	<p>4. M3 Screw (8 mm) x 6</p> 
<p>5. Plain Washer x 2</p> 	

Note: Installation of GV-Mount918 for GV-EFD Series, GV-MFD Series and GV-MDR Series does not require all 6 M3 screws (8 mm) to be used. GV-EFD Series, GV-MFD Series and GV-MDR Series need 2 M3 screws, while GV-EDR Series needs 6 M3 screws for installation. GV-Mount918 cannot be applied to GV-EFD2101/3101/5101.

-
-

GV-Housing102

<p>1. Housing Box</p> 	<p>2. Supporting Tube</p> 
<p>3. Screw Anchor x 4</p> 	<p>4. M5 Screw (35 mm) x 4</p> 
<p>5. Short Screw x 2</p> 	<p>6. M5 Plain Washer (7 mm) x 4</p> 
<p>7. M5 Plain Washer (16 mm) x 2</p> 	<p>8. Hex Key</p> 
<p>9. Silica Gel Bag</p> 	<p>10. Sticker (for Silica Gel Bag)</p>
<p>11. M4 Screw (8 mm) x 4</p> 	<p>12. M4 Screw (5 mm) x 4</p> 
<p>13. Black Plate x 2</p> 	<p>14. Plastic Black Plate</p> 

Note:

1. Installation of GV-Housing102 does not require the plastic black plate (No. 14) to be used.
2. An extra short screw (No.5) and M5 plain washer 16 mm (No.7) are included for future model use.

● GV-Housing103

<p>1. Screw x 3</p> 	<p>2. Plastic Screw Anchor x 3</p> 
<p>3. 1/4" Screw</p> 	<p>4. Washer x 3</p> 
<p>5. Tooth Lock Washer</p> 	<p>6. Hex Key</p> 
<p>7. Silica Gel Bag</p> 	<p>8. Power Adapter</p> 

2. Installing the Fixed IP Dome

2.1 Basic Installation

2.1.1 Assembling the Fixed IP Dome with the Dome Housing



Required accessories:

- GV-Mount902
-

1. Unpack the camera package and remove the camera body.



2 Installing the Fixed IP Dome

2. Secure the camera body to the housing plate (GV-Mount902, No. 6) with 3 small screws (GV-Mount902, No. 7).

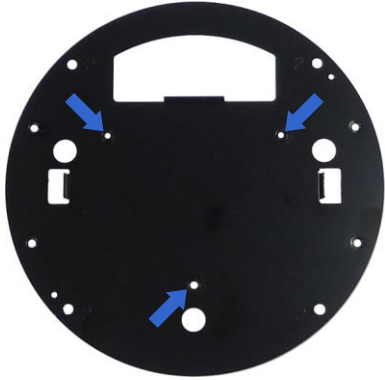

3. Secure the plate to the dome housing with M4 screws (GV-Mount902, No. 3).



4. Secure the housing cap and the dome housing with M6 screws (GV-Mount902, No. 4).



2.1.2 Putting on the Housing Cover

1. Secure the right and left rack (GV-Mount902, No. 5) to the housing cover.



2. Secure the housing cover to the camera with M4 screws (GV-Mount902, No. 3).



2.2 Straight Tube Box Mount

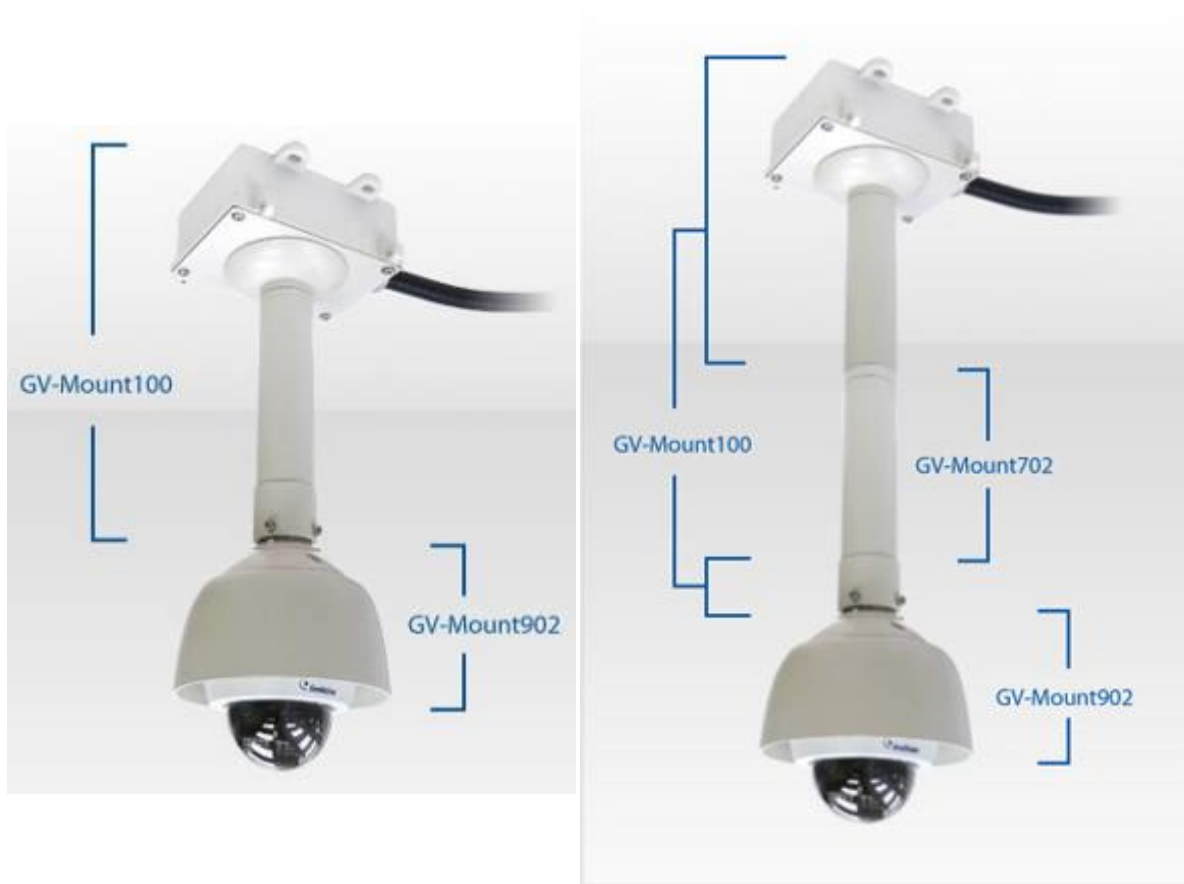

Required accessories:

- GV-Mount100
- GV-Mount902

The user needs to prepare:

- Screws for ceiling x 4
- Corrugated tube x 1 (3/4", \varnothing 26.0 ~ 26.5 mm)



Optionally extend with:

- GV-Mount702
-

1. Assemble the camera with the dome housing. See *2.1.1 Assembling the Fixed IP Dome with the Dome Housing*.
2. Secure the junction box (GV-Mount100, No. 1) to the ceiling with 4 self-prepared screws.



3. Assemble the corrugated tube connector (GV-Mount100, No. 6) with the self-prepared corrugated tube.

A. Dismantle the supplied corrugated tube connector. You should have 4 parts.



B. Slide part A and part B to the self-prepared corrugated tube.

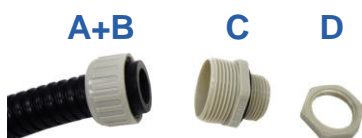

C. Screw part C to the tube.

D. Thread the necessary wires and cables through the corrugated tube, plug the tube to the junction box and secure with part D.

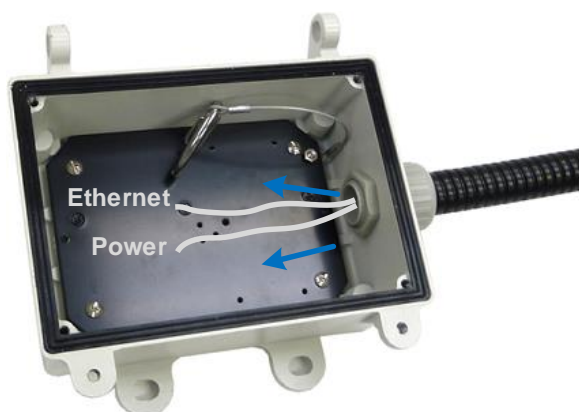

2 Installing the Fixed IP Dome

4. Thread the wires and cables through the box cover (GV-Mount100, No. 2), hook the box cover and secure it with M5 flat screws (GV-Mount100, No. 5).

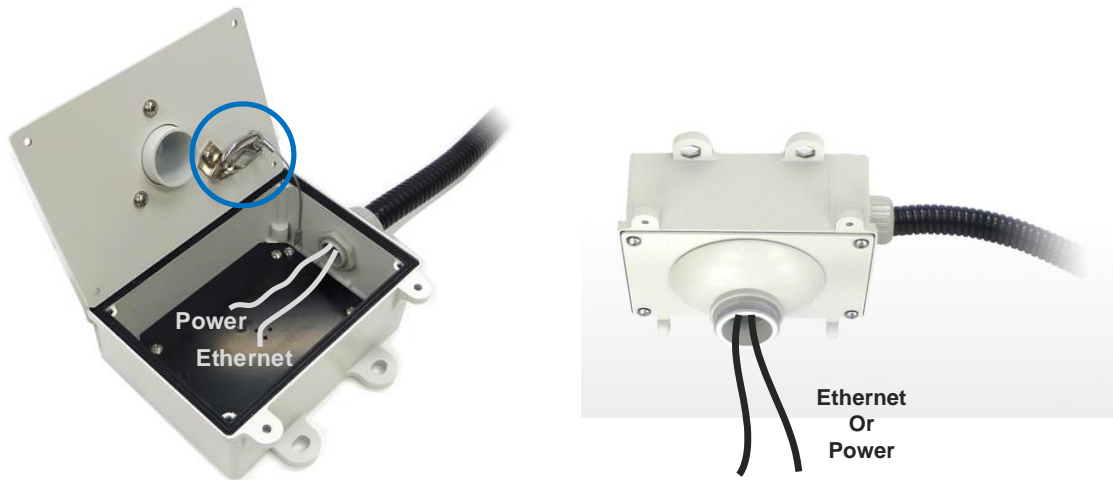

5. Assemble the tube (GV-Mount100, No. 3) and the tube connector (GV-Mount100, No. 4).



6. Thread the wires and cables through the tube, assemble the tube to the box cover and tighten the torxes with the supplied torx wrench (GV-Mount100, No. 7).



7. Thread the wires and cables through the housing cap (GV-Mount902, No. 2) and secure the tube to the end of the housing cap with M6 screws (GV-Mount902, No. 4).
8. Put on the housing cover. See *2.1.2 Putting on the Housing Cover*.

2.3 Straight Tube Mount



Required accessories:

- GV-Mount101
- GV-Mount902

The user needs to prepare:

- Screws for ceiling x 4

Optionally extend with:

- GV-Mount702
-

1. Assemble the camera with the dome housing. See *2.1.1 Assembling the Fixed IP Dome with the Dome Housing*.
2. Thread the necessary cables and wires from the ceiling through the mounting bracket (GV-Mount101, No. 1) and secure the bracket to the ceiling with 4 self-prepared screws.



3. Assemble the tube (GV-Mount101, No. 2) and the tube connector (GV-Mount101, No. 3).



4. Thread the cables and wires into the tube, assemble the tube to the pendant mount bracket and tighten the torxes with the supplied torx wrench (GV-Mount101, No. 4).



5. Thread the cables and wires into the dome housing and connect the network, power and other cables.

2 Installing the Fixed IP Dome

6. Secure the tube to the end of the housing cap (GV-Mount902, No. 2) with M6 screws (GV-Mount101, No. 4).



7. Put on the housing cover. See 2.1.2 *Putting on the Housing Cover*.

2.4 Wall Mount



Required accessories:

- GV-Mount205
-

1. Take the wall mount bracket (GV-Mount205, No. 1) and make 4 marks on the wall for screw anchors.



2. Drill the marks and insert 4 screw anchors (GV-Mount205, No. 6).
3. Align and secure the mounting plate (GV-Mount205, No. 2) to the wall mount bracket with 4 M4 screws (GV-Mount205, No. 4).

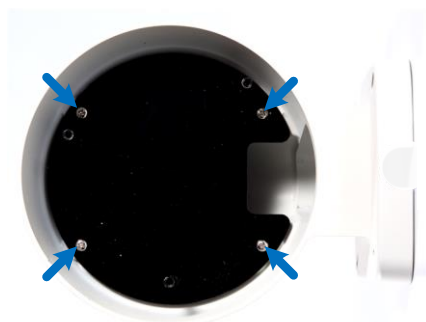

2 Installing the Fixed IP Dome

4. Align and secure the housing plate (GV-Mount205, No. 3) to the mounting plate with 3 M4 screws (GV-Mount205, No. 4).

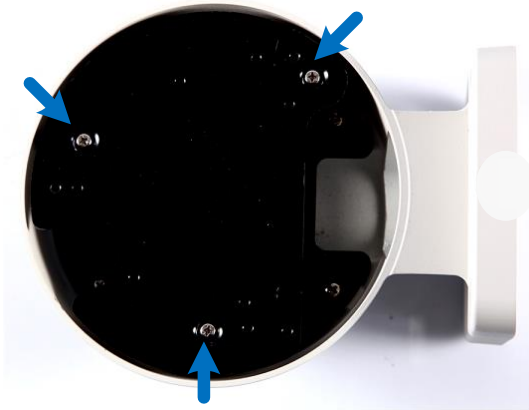

5. Unpack and remove the camera cover with supplied torx wrench.



6. Align and secure the camera body to the housing plate with 3 M4 screws (GV-Mount205, No. 4).

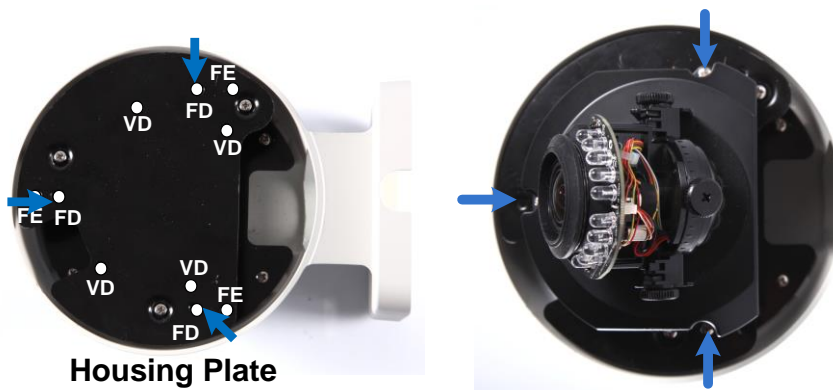

7. Thread the camera cables through the wall mount bracket.

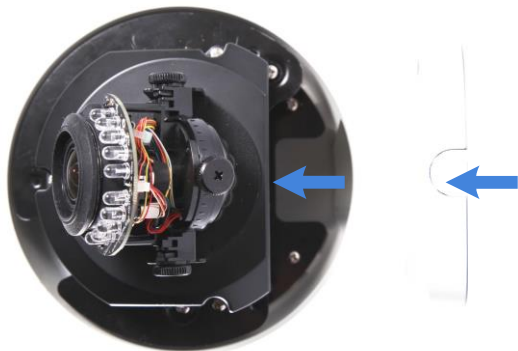

8. Secure the wall mount bracket to the wall with 40 mm M4 screws (GV-Mount205, No. 5) and plain washers (GV-Mount205, No. 7).

2.5 Wall Box Mount



Required accessories:

- GV-Mount909
-

1. Take the wall mount bracket (GV-Mount909, No. 1) and make 4 marks on the wall for screw anchors.



2. Drill the marks and insert screw anchors (GV-Mount909, No. 2).
3. Secure the wall mount bracket to the wall with wall mount screws (GV-Mount909, No. 3).

4. Unpack and remove the camera cover with the supplied torx wrench.



5. Align and secure the camera body to the wall mount bracket with three M3 screws (GV-Mount909, No. 4).

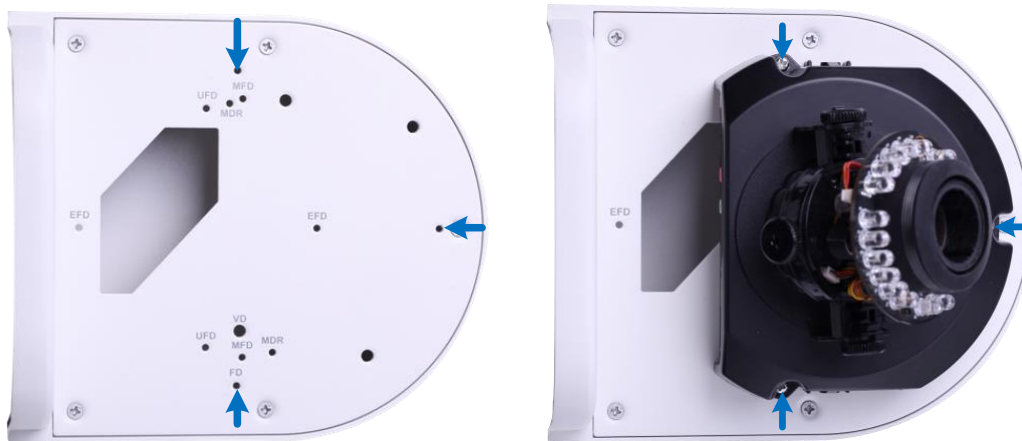

2.6 Wall Pendant Mount



Required accessories:

- GV-Mount200
- GV-Mount902

The user needs to prepare:

- Screws for wall x 4
-

1. Assemble the camera with the dome housing. See *2.1.1 Assembling the Fixed IP Dome with the Dome Housing*.
2. On the installation site, thread the necessary cables and wires from the wall through the pendant tube (GV-Mount200, No. 1), and secure the tube to the wall with 4 screws of your choice.



3. Thread the cables and wires into the dome housing and secure the pendant tube to the end of the housing cap (GV-Mount902, No. 2) with M6 screws (GV-Mount902, No. 4).



4. Put on the housing cover. See 2.1.2 *Putting on the Housing Cover*.

2.7 Convex Corner Mount



Required accessories:

- GV-Mount200
- GV-Mount300-1
- GV-Mount902

The user needs to prepare:

- Screws for wall x 8
-

1. Assemble the camera with the dome housing. See *2.1.1 Assembling the Fixed IP Dome with the Dome Housing*.
2. Assemble the mounting plates (GV-Mount300-1, No. 1), slide in the plain washer (GV-Mount300-1, No. 4), then the split washer (GV-Mount300-1, No. 5), and secure them with the screw cap (GV-Mount300-1, No. 6).

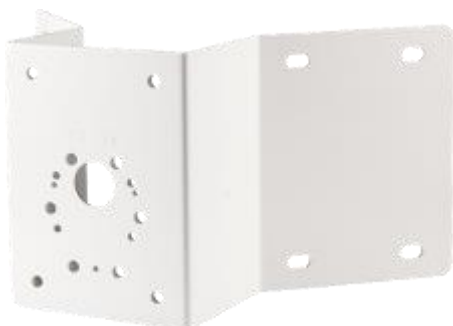

3. Secure the pendant tube (GV-Mount200, No. 1) to the plate. Slide the 30 mm M8 screws (GV-Mount300-1, No. 2) from the front and secure from the backside using plain washers (GV-Mount300-1, No. 4), split washers (GV-Mount300-1, No. 5) and the M8 screw caps (GV-Mount300-1, No. 6).

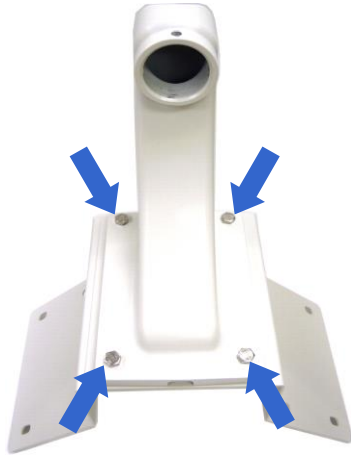

Backside View

4. Thread the necessary wires and cables through the pendant tube and secure the plate to the wall with 8 self-prepared screws.
5. Thread the wires and cables into the dome and connect the network, power and other cables to the camera.
6. Secure the pendant tube to the end of the housing cap (GV-Mount902, No. 2) with M6 screws (GV-Mount902, No. 4).
7. Put on the housing cover. See 2.1.2 *Putting on the Housing Cover*.

2.8 Convex Corner Box Mount



Required accessories:

- GV-Mount203
- GV-Mount300-1
- GV-Mount902

The user needs to prepare:

- Screws for wall x 8
- Corrugated tube x 1 (3/4", \varnothing 26.0 ~ 26.5 mm)



1. Assemble the camera with the dome housing. See *2.1.1 Assembling the Fixed IP Dome with the Dome Housing*.
2. Assemble the mounting plates (GV-Mount300-1, No. 1), slide in the plain washer (GV-Mount300-1, No. 4), then the split washer (GV-Mount300-1, No. 5), and secure them with the screw cap (GV-Mount300-1, No. 6).

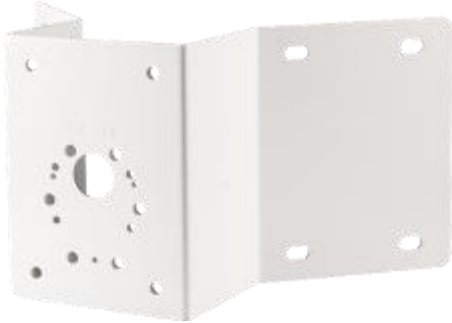

3. Secure the junction box (GV-Mount203, No. 1) to the mounting plate from the back side using the 25 mm M8 screw (GV-Mount300-1, No. 3), plain washer (GV-Mount300-1, No. 4), split washer (GV-Mount300-1, No. 5) and the M8 screw cap (GV-Mount300-1, No. 6).

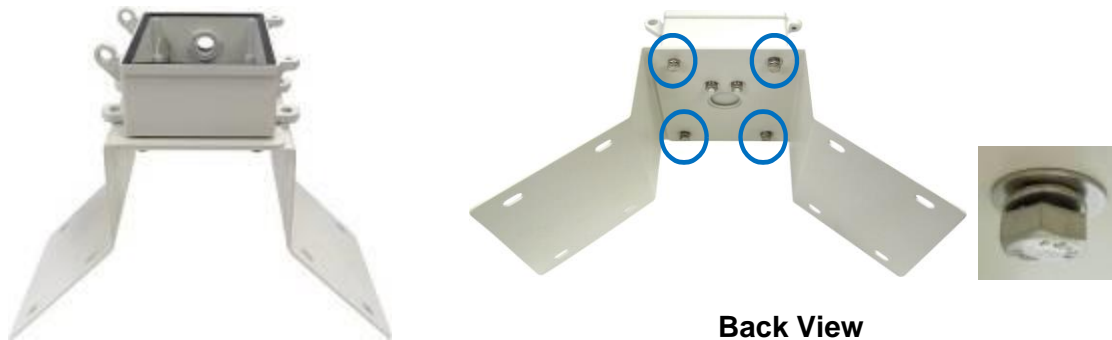

4. Secure the mounting plate to the wall with 8 self-prepared screws. Face the conduit exit downward.
5. Assemble the corrugated tube connector (GV-Mount203, No. 4) with the self-prepared corrugated tube.
 - A. Dismantle the supplied corrugated tube connector. You should have 4 parts.



- B. Slide part A and part B to the self-prepared corrugated tube.

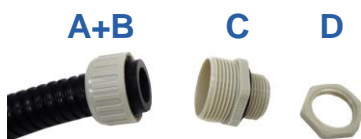

- C. Screw part C to the tube.

2 Installing the Fixed IP Dome

- D. Thread the necessary wires and cables through the corrugated tube, plug the tube to the box and secure with part D.

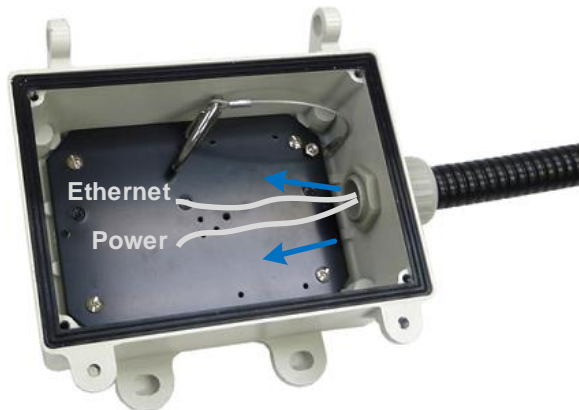

6. Hinge and hook the pendant tube (GV-Mount203, No. 2) to the junction box.



7. Thread the wires and cables through the pendant tube into the dome housing and connect them to the camera.
8. Secure the pendant tube to the end of the housing cap (GV-Mount902, No. 2) with M6 screws (GV-Mount902, No. 4).



9. Conceal the junction box with M5 screws using the torx wrench (GV-Mount203, No. 5).
10. Put on the housing cover. See 2.1.2 *Putting on the Housing Cover*.

2.9 Concave Corner Mount



Required accessories:

- GV-Mount200
- GV-Mount310-1
- GV-Mount902

The user needs to prepare:

- Screws for wall x 8
-

1. Assemble the camera with the dome housing. See *2.1.1 Assembling the Fixed IP Dome with the Dome Housing*.
2. Assemble the mounting plates (GV-Mount310-1, No. 1), slide in the plain washer (GV-Mount310-1, No. 3), then the split washer, and secure them with the screw cap.



- Secure the pendant tube (GV-Mount200, No. 1) to the plate. Slide the 30 mm M8 screws (GV-Mount310-1, No. 2) from the front and secure from the back using plain washers (GV-Mount310-1, No. 3), split washers (GV-Mount310-1, No. 4) and the M8 screw caps (GV-Mount310-1, No. 5).



Front View

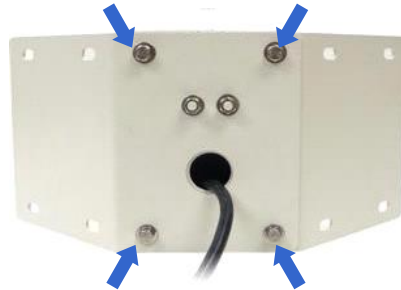

Back View



- Thread the necessary wires and cables through the pendant tube and secure the plate to the wall with 8 self-prepared screws.
- Connect the network, power and other cables to the camera.
- Secure the pendant tube to the end of the housing cap (GV-Mount902, No. 2) with M6 screws (GV-Mount902, No. 4).
- Put on the housing cover. See *2.1.2 Putting on the Housing Cover*.

2.10 Pole Mount



Required accessories:

- GV-Mount200
 - GV-Mount400-1 / 410-1
 - GV-Mount902
-

1. Assemble the camera with the dome housing. See 2.1.1 *Assembling the Fixed IP Dome with the Dome Housing*.
2. Secure the pendant tube (GV-Mount200, No. 1) to the mounting bracket (GV-Mount400-1 / 410-1, No. 1). Slide the 30 mm M8 screws (GV-Mount400-1 / 410-1, No. 3) from the front and secure from the backside using plain washer (GV-Mount400-1 / 410-1, No. 5), split washer (GV-Mount400-1 / 410-1, No. 6) and screw cap (GV-Mount400-1 / 410-1, No. 7).



Backside View

3. Thread the necessary wires and cables through the pendant tube and secure the mounting bracket to the pole using 3 steel straps (GV-Mount400-1 / 410-1, No. 2). Rotate the screw on the strap to adjust its size.



4. Thread the wires and cables into the dome housing and connect the network, power and other cables to the camera.
5. Secure the pendant tube to the end of the housing cap (GV-Mount902, No. 2) with M6 screws (GV-Mount902, No. 4).
6. Put on the housing cover. See 2.1.2 *Putting on the Housing Cover*.

2.11 Pole Box Mount



Required accessories:

- GV-Mount203
- GV-Mount400-1 / 410-1
- GV-Mount902

The user needs to prepare:

- Corrugated tube x 1 (3/4", \varnothing 26.0 ~ 26.5 mm)



-
1. Assemble the camera with the dome housing. See *2.1.1 Assembling the Fixed IP Dome with the Dome Housing*.

2. Assemble the mounting bracket (GV-Mount400-1 / 410-1, No. 1) and the junction box (GV-Mount203, No. 1) from the backside using 25 mm M8 screws (GV-Mount400-1 / 410-1, No. 4), plain washer (GV-Mount400-1 / 410-1, No. 5) and split washers (GV-Mount400-1 / 410-1, No. 6).



Backside View

3. Secure the mounting bracket to the pole using 3 steel straps (GV-Mount400-1 / 410-1, No. 2). Rotate the screw on the strap to adjust its size. Face the conduit exit downward.



4. Assemble the corrugated tube connector (GV-Mount203, No. 4) with the self-prepared corrugated tube.

- A. Dismantle the supplied corrugated tube connector. You should have 4 parts.



- B. Slide part A and part B to the self-prepared corrugated tube.



- C. Screw part C to the tube.

2 Installing the Fixed IP Dome

- D. Thread the necessary wires and cables through the corrugated tube, plug the tube to the box and secure with part D.

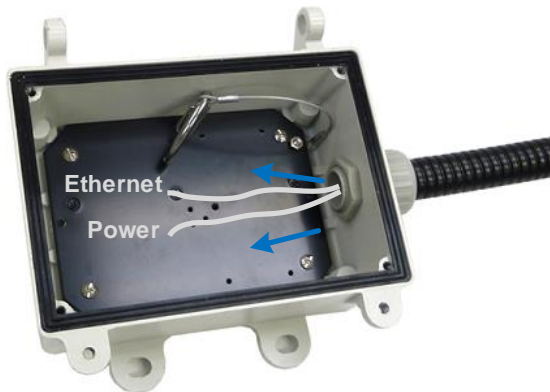

5. Hinge and hook the pendant tube (GV-Mount203, No. 2) to the junction box.



6. Thread the wires and cables through the pendant tube into the dome housing and connect the network, power and other cables to the camera.
7. Secure the pendant tube to the end of the housing cap (GV-Mount902, No. 2) with M6 screws (GV-Mount902, No. 4).
8. Conceal the junction box with M5 screws (GV-Mount203, No. 3) using the torx wrench (GV-Mount203, No. 5).
9. Put on the housing cover. See 2.1.2 *Putting on the Housing Cover*.

2.12 Power Box Mount



Required accessories:

- GV-Mount913

The user needs to prepare

- Screws for securing the mounting plate to power box

1. Secure the mounting plate (GV-Mount913, No. 1) to the power box with your own screws. Depending on the type of power box, use the holes indicated with the corresponding letter:

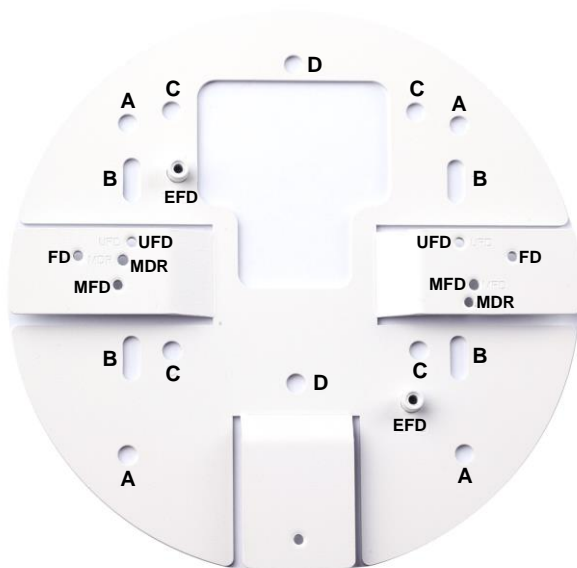

Type of Power Box	Hole
4" Square	A
Double Gang	B
4" Octagon	C
Single Gang	D

2 Installing the Fixed IP Dome

2. Unpack the camera.



3. Secure the camera to the mounting plate with M3 screws (GV-Mount913, No. 2). Use the holes indicated with “FD” to help you align the camera.

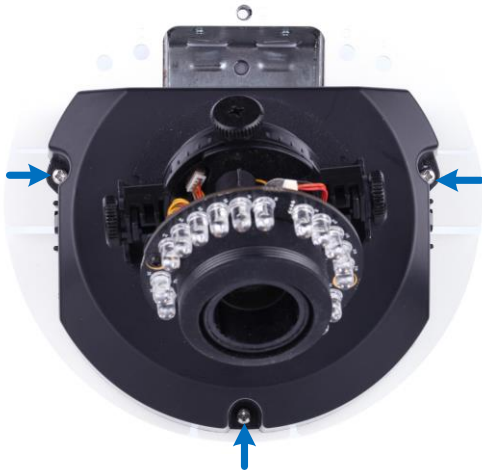

4. Follow step 2 to put on the camera cover.

3. Installing the Fisheye Camera

The instructions in this chapter only apply to **GV-FER5702**, **FER12700**, and **QFER12700**.

3.1 Dome Housing

This section describes different dome housings for GV-FER12700 and GV-QFER12700.

3.1.1 GV-FER12700



Required accessories:

- GV-Mount903-1
-

1. Align the embossed arrow of the housing cap (GV-Mount903-1, No. 2) with the arrow inside the dome housing (GV-Mount903-1, No. 1) and secure them with three M6 screws (GV-Mount903-1, No. 4).

3 Installing the Fisheye Camera



Tip: The flat hole on the housing cap should be fitted with the hole on the housing cover without any indent.

2. Secure the camera back plate to the dome housing with three M4 screws (GV-Mount903-1, No. 3) and then secure the camera body onto the back plate.

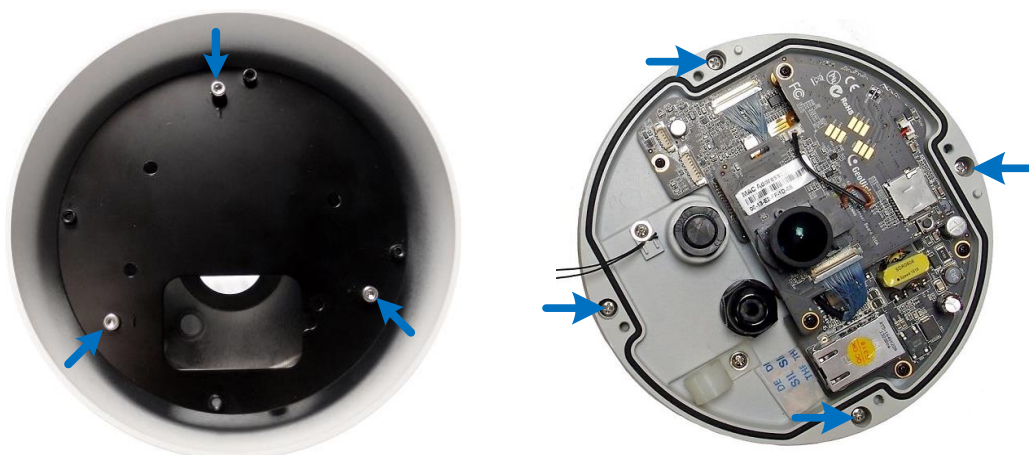

3. Place the camera cover on the camera and fasten the screws with the supplied torx wrench. And secure its safety lock to the camera and then fasten the screws.

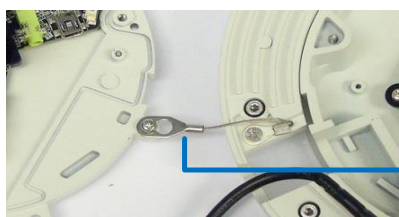
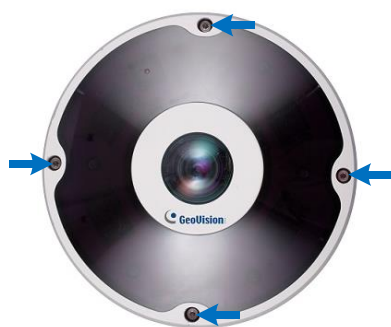

Safety Lock

3.1.2 GV-QFER12700



Required accessories:

- GV-Mount903-1
 - GV-Mount903-2 (only for GV-QFER12700)
-

1. Align the embossed arrow of the housing cap (GV-Mount903-1 / 903-2, No. 2) with the arrow inside the dome housing (GV-Mount903-1, No. 1) and secure them with the supplied M6 screws (GV-Mount903-1 / 903-2, No. 4).



Tip: The flat hole on the housing cap should be fitted with the hole on the housing cover without any indent.

3 Installing the Fisheye Camera

2. Assemble the housing plates to the dome housing.
 - A. For **GV-Mount901-1**, secure the Bottom Plate (GV-Mount901-1, No. 8) to the dome housing with the supplied flat M4 screws (GV-Mount901-1, No. 6). For **GV-Mount 903-1 / 903-2**, skip this step.

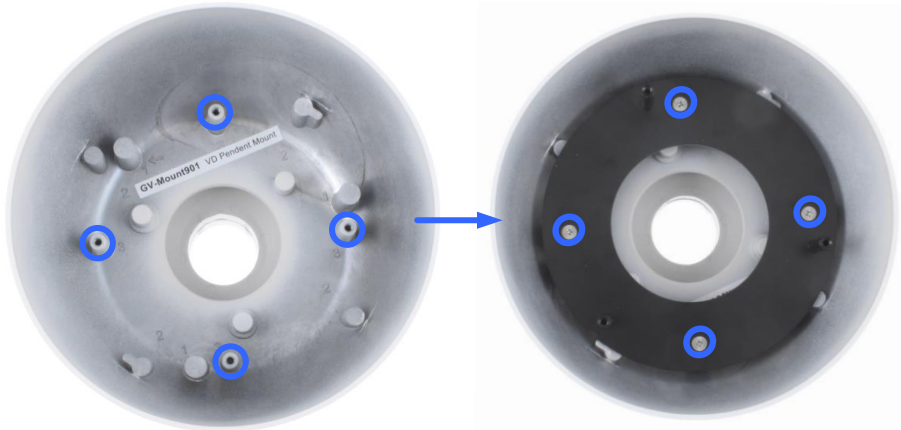

- B. Secure the Housing Plate (GV-Mount903-1 / 903-2, No. 7) to the dome housing with the supplied flat M4 screws (GV-Mount903-1 / 903-2, No. 6).
3. Thread the camera cable through the dome housing.
4. Secure GV-Mount912-1 (GV-Mount903-1 / 903-2, No. 8) onto the housing plate with three M3 screws (GV-Mount903-1 / 903-2, No. 5). Use the indicated holes on the back plate / GV-Mount912-1.



5. Unscrew the camera cover.

6. Secure the camera onto GV-Mount912-1 (GV-Mount903-1 / 903-2, No. 8) with two M4 screws (GV-Mount903-1 / 903-2, No. 9).



GV-QFER12700

7. Secure the camera cover.

3.2 Straight Tube Box Mount



Required accessories:

- GV-Mount100
- GV-Mount903-1

The user needs to prepare:

- Screws for ceiling x 4
- Corrugated tube x 1 (3/4", \varnothing 26.0 ~ 26.5 mm)



Optionally extend with:

- GV-Mount702
-

1. Assemble the camera to the dome housing. See *3.1 Dome Housing*.
2. Assemble the tube (GV-Mount100, No. 3) and the tube connector (GV-Mount100, No. 4).



3. Thread the camera cable through the tube and secure the tube to the end of the housing cap (GV-Mount903-1, No.2) with M6 screws (GV-Mount903-1, No.4).



4. Thread the camera cable through the box cover (GV-Mount100, No. 2), assemble the box cover and the tube, and tighten the torxes with the supplied torx wrench (GV-Mount100, No. 7).



3 Installing the Fisheye Camera

5. Secure the junction box (GV-Mount100, No. 1) to the ceiling with 4 self-prepared screws.



6. Assemble the corrugated tube connector (GV-Mount100, No. 6) with the self-prepared corrugated tube.

- A. Dismantle the supplied corrugated tube connector. You should have 4 components.



- B. Slide part A and part B to the self-prepared corrugated tube.

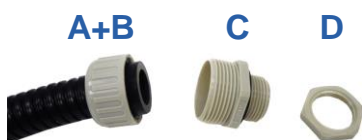

- C. Screw part C to the tube.

- D. Thread the necessary wires and cables from the ceiling through the corrugated tube, plug the tube to the box and secure with part D.

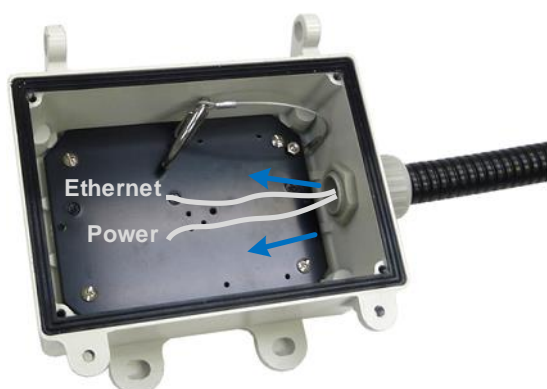

7. Connect the network, power and other cables to the camera.

8. Hinge and hook the box cover and secure it with M5 flat screws (GV-Mount100, No. 5).

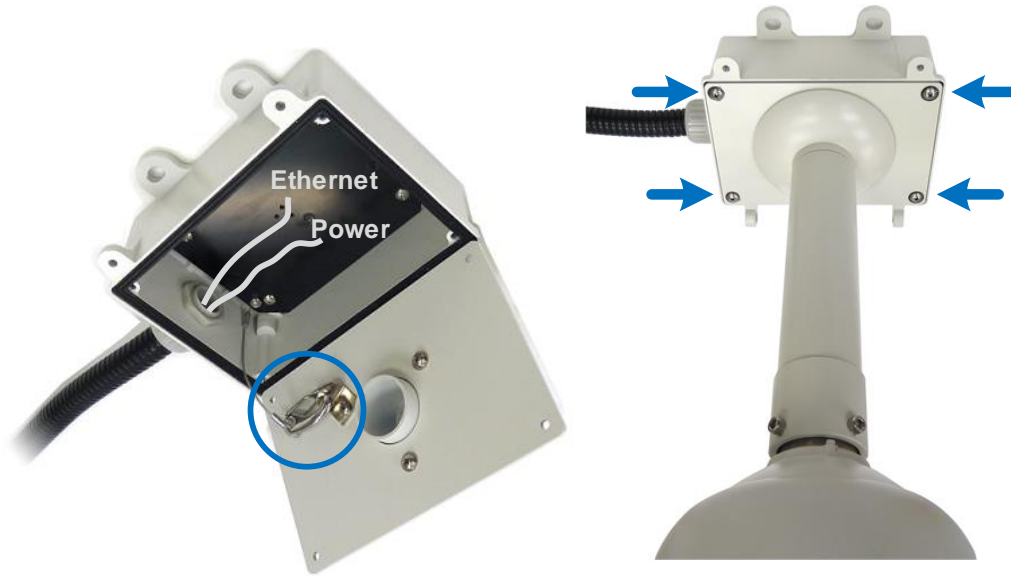

3.3 Straight Tube Mount



Required accessories:

- GV-Mount101
- GV-Mount903-1

The user needs to prepare:

- Screws for ceiling x 4

Optionally extend with:

- GV-Mount702
-

1. Assemble the camera with the dome housing. See 3.1 *Dome Housing*.
2. Assemble the tube (GV-Mount101, No. 2) and the tube connector (GV-Mount101, No. 3).



3. Thread the camera cable through the tube and secure the tube to the end of the housing cap (GV-Mount903-1, No.2) with M6 screws (GV-Mount903-1, No.4).



4. Thread the camera cable through the mounting bracket (GV-Mount101, No. 1) and assemble the tube with the mounting bracket.
5. Make sure the tubes are properly screwed and tighten the torxes using the supplied torx wrench (GV-Mount101, No. 4).



6. Secure the assembled camera to a desired location with 4 self-prepared screws.

3.4 Wall Mount Bracket



Required accessories:

- GV-Mount206
 - GV-Mount206-1 (only for GV-QFER12700)
-

1. Take the wall mount bracket (GV-Mount206 / 206-, No. 1) and make 4 marks on the wall for screw anchors.



2. Drill the marks and insert screw anchors (GV-Mount206 / 206-1, No. 6).

- Align and secure the mounting plate (GV-Mount206 / 206-1, No. 2) to the wall mount bracket with four M4 screws (GV-Mount206 / 206-1, No. 4).

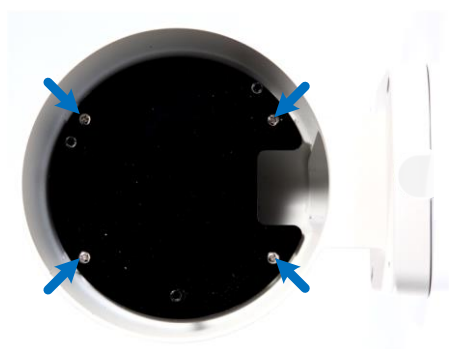

- Align and secure the housing plate (GV-Mount206 / 206-1, No. 3) to the mounting plate with three M4 screws (GV-Mount206 / 206-1, No. 4).



- For **GV-FER12700**, secure the back plate of the camera onto the housing plate with four M4 screws (GV-Mount206 / 206-1, No. 4). For **GV-QFER12700**, secure GV-Moun912-1 (GV-Mount206 / 206-1, No. 9) onto the housing plate with four M4 screws (GV-Mount206 / 206-1, No. 4). Use the indicated holes on the back plate / GV-Mount912-1.

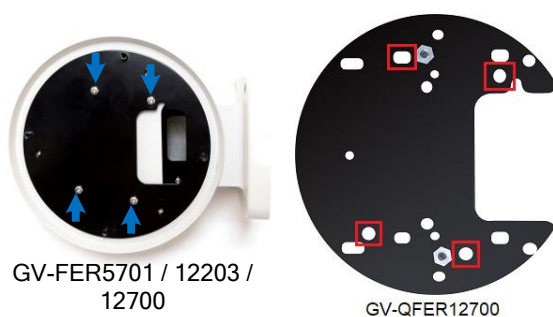

- Thread the camera cable through the wall mount bracket.

3 Installing the Fisheye Camera

7. For **GV-FER12700**, align and secure the camera onto the back plate. For **GV-QFER12700**, secure the camera onto GV-Mount912-1 using two M4 screws (GV-Mount206 / 206-1, No. 10).

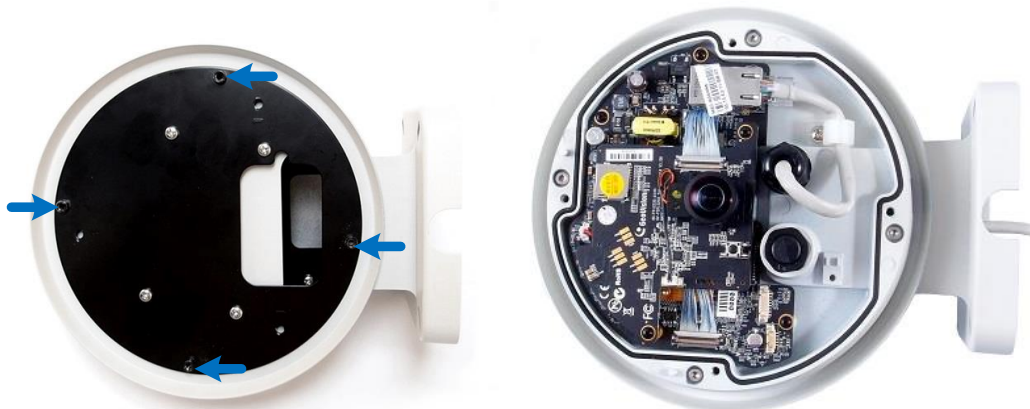

GV-FER12700



GV-QFER12700

8. Secure the camera cover using the supplied torx wrench.



9. Secure the wall mount bracket to the wall with 40 mm M4 screws (GV-Mount206 / 206-1, No. 5) and plain washers (GV-Mount206 / 206-1, No. 7).

3.5 Wall Pendant Mount



Required accessories:

- GV-Mount200
- GV-Mount903-1

The user needs to prepare:

- Screws for wall x 4
-

1. Assemble the Fisheye camera with the dome housing. See [3.1 Dome Housing](#).
2. Insert the housing cap (GV-Mount903-1, No.2) into the wall pendant tube (GV-Mount200, No. 1) and secure the tube to the end of the housing cap (GV-Mount903-1, No.2) with M6 screws (GV-Mount903-1, No.4).



3. Place the wall pendant tube on the wall and secure with four screws of your choice.

3.6 Tilting Wall Mount



Front View



Side View: Flat



Side View: Tilted

Required accessories:

- GV-Mount904-1
 - GV-Mount904-2 (only for GV-QFER12700)
-

1. Unscrew the housing cover from the camera using the supplied hex key (GV-Mount904-1 / 904-2, No. 1).

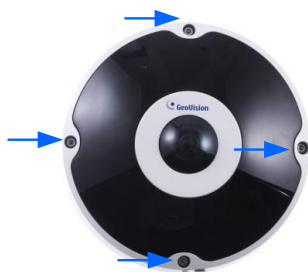

2. Paste the sticker (GV-Mount904-1 / 904-2, No. 6) to the wall. Drill the 3 red dots and insert the supplied plastic screw anchor (GV-Mount904-1 / 904-2, No. 3). Secure GV-Mount904-1 to the wall using 3 wall mount screws (GV-Mount904-1 / 904-2, No. 4).

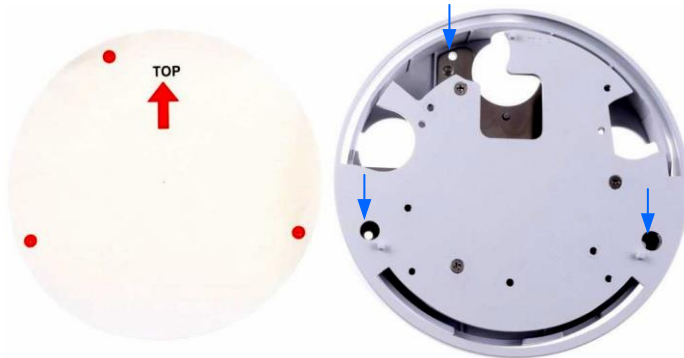

4. For **GV-FER12700**, secure the black back plate from the camera to GV-Mount904-1 using three M3 screws (GV-Mount904-1 / 904-2, No. 5). For **GV-QFER12700**, secure GV-Mount912-1 (GV-Mount904-1 / 904-2, No. 7) to GV-Mount904-2 using three M3 screws (GV-Mount904-1 / 904-2, No. 5). Use the indicated holes on the black back plate / GV-Mount912-1.



5. For **GV-FER12700**, thread the camera cable into an opening on GV-Mount904-1.



Tip: Pull the tilting rack to a wider angle for easier threading.



6. For **GV-FER12700**, align and secure the camera body using the supplied hex key to its black back plate. For **GV-QFER12700**, secure the camera onto GV-Mount912-1 using two M4 screws (GV-Mount904-1 / 904-2, No. 8). Then, insert a micro SD card to the camera.

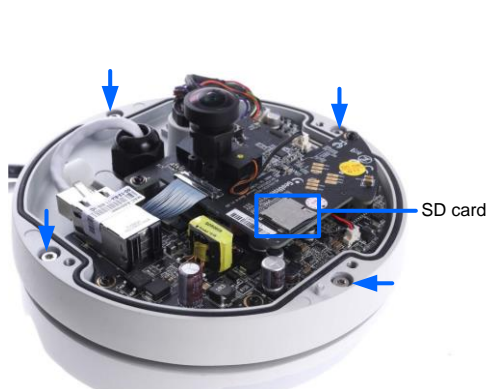

GV-QFER12700

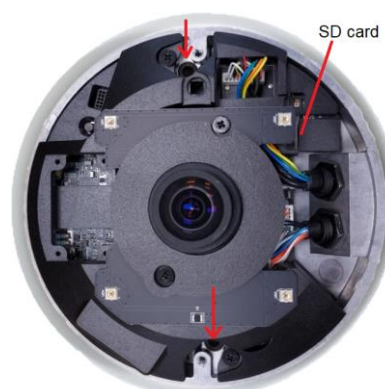

GV-FER12700

7. Assemble and secure the housing cover to the camera body using the supplied hex key.

IMPORTANT: The live view image is upside down after you have finished installing GV-Mount904-1. You can adjust the image orientation by rotating 180° by using the camera's Web interface.

3.7 Convex Corner Mount



Required accessories:

- GV-Mount200
- GV-Mount300-1
- GV-Mount903-1 / GV-Mount903-2 (only for GV-QFER12700)

The user needs to prepare:

- Screws for wall x 8
-

IMPORTANT: GV-Fisheye Cameras with IR LED do not support GV-Mount300-1 except for GV-QFER12700.

1. Assemble the camera with the dome housing. See 3.1.2 *GV-QFER12700*.
2. Thread the camera cable through the wall pendant tube (GV-Mount200, No. 1), and secure the tube to the end of the housing cap (GV-Mount903-1 / 903-2, No.2) with M6 screws (GV-Mount903-1 / 903-2, No. 4).



3 Installing the Fisheye Camera

3. Assemble the mounting plates (GV-Mount300-1, No. 1), slide in the plain washer (GV-Mount300-1, No. 4), then the split washer (GV-Mount300-1, No. 5), and secure with the screw cap (GV-Mount300-1, No. 6).

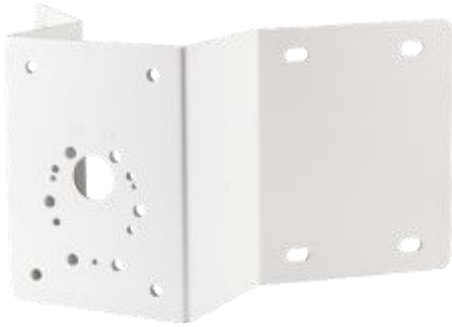

4. Thread the camera cable and secure the pendant tube to the plates. Slide the 30 mm M8 screws (GV-Mount300-1, No. 2) from the front and secure from the backside using plain washer (GV-Mount300-1, No. 4), split washer (GV-Mount300-1, No. 5) and screw cap (GV-Mount300-1, No. 6).



Backside View

5. Secure the plates to the wall with 8 self-prepared screws.

3.8 Convex Corner Box Mount



Required accessories:

- GV-Mount203
- GV-Mount300-1
- GV-Mount903-1 / GV-Mount903-2 (only for GV-QFER12700)

The user needs to prepare:

- Screws for wall x 8
- Corrugated tube x 1 (3/4", \varnothing 26.0 ~ 26.5 mm)



IMPORTANT: GV-Fisheye Cameras with IR LED do not support GV-Mount203 / 300 / 300-1 except for GV-QFER12700.

1. Assemble the camera with the dome housing. See 3.1.2 *GV-QFER12700*.
2. Assemble the mounting plates (GV-Mount300-1, No. 1), slide in the plain washer (GV-Mount300-1, No. 4), then the split washer (GV-Mount300-1, No. 5), and secure them with the screw cap (GV-Mount300-1, No. 6).



3 Installing the Fisheye Camera

- Secure the junction box (GV-Mount203, No. 1) to the mounting plates from the backside using the 25 mm M8 screw (GV-Mount300-1, No. 3), plain washer (GV-Mount300-1, No. 4), and split washer (GV-Mount300-1, No. 5).

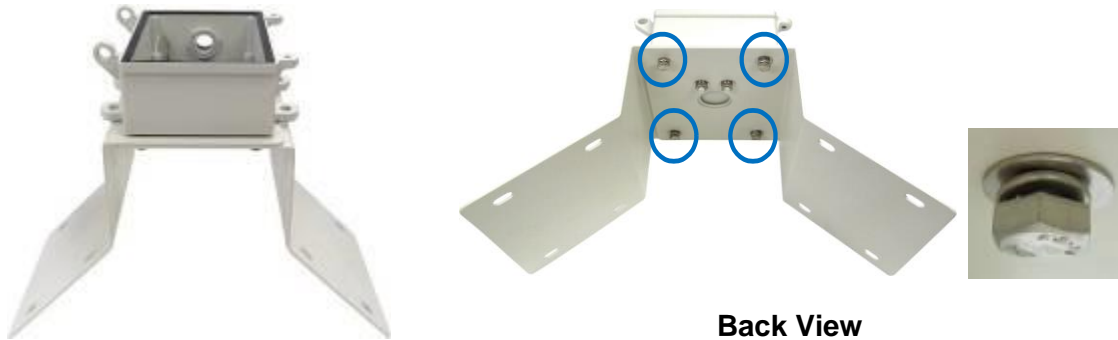

- Secure the mounting plates to the wall with 8 self-prepared screws. Face the conduit exit downward.
- Assemble the corrugated tube connector (GV-Mount203, No. 4) with the self-prepared corrugated tube.
 - Dismantle the supplied corrugated tube connector. You should have 4 parts.



- Slide part A and part B to the self-prepared corrugated tube.

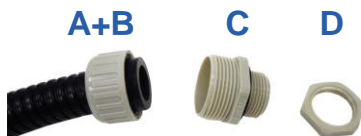

- Screw part C to the tube.
- Thread the necessary wires and cables from the wall or the ceiling through the corrugated tube, plug the tube to the box and secure with part D.

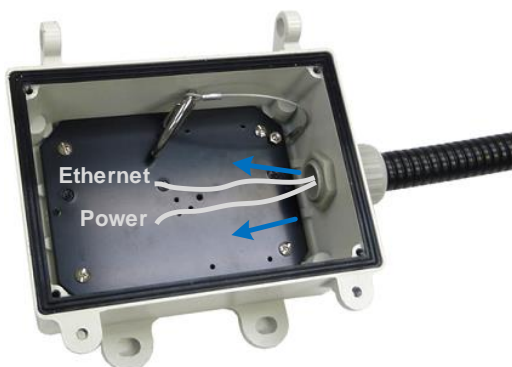

6. Thread the camera cable through the wall pendant tube (GV-Mount203, No. 2), and secure the tube to the end of the housing cap (GV-Mount903-1 / 903-2, No. 2) with M6 screws (GV-Mount903-1 / 903-2, No. 4).

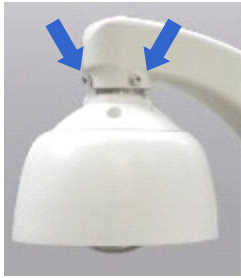

7. Hinge and hook the pendant tube to the junction box.



8. Connect the network, power and other cables to the camera.
9. Conceal the box with M5 screws (GV-Mount203, No. 3) using the torx wrench (GV-Mount203, No. 5).

3.9 Concave Corner Mount

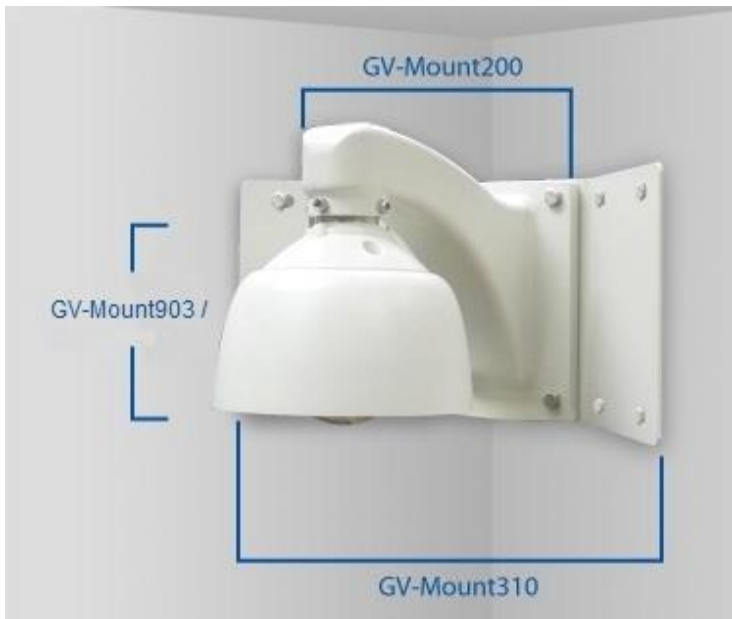

Required accessories:

- GV-Mount200
- GV-Mount310 / 310-1
- GV-Mount903-1 / GV-Mount903-2 (only for GV-QFER12700)

The user needs to prepare:

- Screws for wall x 8
-

IMPORTANT: GV-Fisheye Camera with IR LED do not support GV-Mount310 / 310-1 except for GV-QFER12700.

1. Assemble the camera with the dome housing. See 3.1.2 *GV-QFER12700*.
2. Assemble the mounting plates (GV-Mount310 / 310-1, No. 1), slide in the plain washer (GV-Mount310 / 310-1, No. 3), then the split washer (GV-Mount310 / 310-1, No. 4), and secure them with the screw cap (GV-Mount310 / 310-1, No. 5).



3. Thread the camera cable through the wall pendant tube (GV-Mount200, No. 1), and secure the tube to the end of the housing cap (GV-Mount903-1 / 903-2, No. 2) with M6 screws (GV-Mount903-1 / 903-2, No. 4).



4. Thread the camera cable and secure the pendant tube to the plates. Slide the 30 mm M8 screws (GV-Mount310 / 310-1, No. 2) from the front and secure from the backside using plain washer (GV-Mount310 / 310-1, No. 3), split washer (GV-Mount310 / 310-1, No. 5) and secure with M8 screw cap (GV-Mount310 / 310-1, No. 6).



Front View

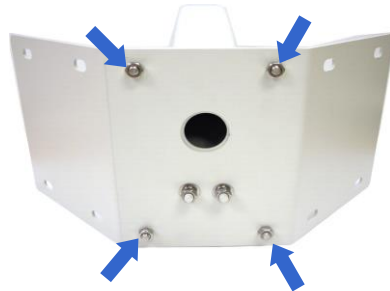

Back View



5. Secure the plates to the wall with 8 self-prepared screws.

3.10 Pole Mount



Required accessories:

- GV-Mount200
 - GV-Mount400 / 410 / 400-1 / 410-1
 - GV-Mount903-1
-

Important: GV-Fisheye Cameras with IR LED do not support GV-Mount400 / 410 / 400-1 / 410-1.

1. Assemble the camera with the dome housing. See 3.1.1 *GV-FER12700* or 3.1.2 *GV-QFER12700*.
2. Secure the mounting bracket (GV-Mount400 / 410 / 400-1 / 410-1, No. 1) to the pole using 3 steel straps (GV-Mount400 / 410 / 400-1 / 410-1, No. 2). Rotate the screw on the strap to adjust its size.

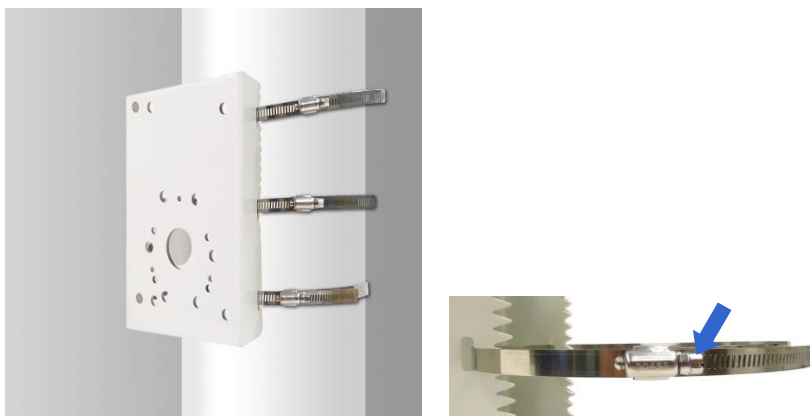

3. Thread the camera cable through the pendant tube (GV-Mount200, No. 1) and secure the tube to the end of the housing cap (GV-Mount903-1, No. 2) with M6 screws (GV-Mount903-1, No. 4).



4. Thread the camera cable through the mounting bracket and secure the pendant tube to the bracket. Slide the 30 mm M8 screws (GV-Mount400 / 410 / 400-1 / 410-1, No. 3) from the front and secure from the backside using plain washer (GV-Mount400 / 410 / 400-1 / 410-1, No. 5), split washer (GV-Mount400 / 410 / 400-1 / 410-1, No. 6) and screw cap (GV-Mount400 / 410 / 400-1 / 410-1, No. 7).



Backside View

3.11 Pole Box Mount



Required accessories:

- GV-Mount203
- GV-Mount400 / 410 / 400-1 / 410-1
- GV-Mount903-1

Required accessories:

- Corrugated tube x 1 (3/4", \varnothing 26.0 ~ 26.5 mm)



IMPORTANT: GV-Fisheye Camera with IR LED do not support GV-Mount203 / 400 / 410 / 400-1 / 410-1.

1. Assemble the camera with the dome housing. See 3.1.1 *GV-FER12700* or 3.1.2 *GV-QFER12700*.

1. Secure the junction box (GV-Mount203, No. 1) to the mounting bracket (GV-/ 410 / 400-1 / 410-1, No. 1) from the backside using 25 mm M8 screws (GV-Mount400 / 410 / 400-1 / 410-1, No. 4), plain washer (GV-Mount400 / 410 / 400-1 / 410-1, No. 5) and split washers (GV-Mount400 / 410 / 400-1 / 410-1, No. 6).



Backside View

2. Secure the mounting bracket to the pole using 3 steel straps (GV-Mount400 / 410 / 400-1 / 410-1, No. 2). Rotate the screw on the strap to adjust its size. Face the conduit exit downward.



3. Assemble the corrugated tube connector (GV-Mount203, No. 4) with the self-prepared corrugated tube.

- A. Dismantle the supplied corrugated tube connector. You should have 4 parts.



- B. Slide part A and part B to the self-prepared corrugated tube.

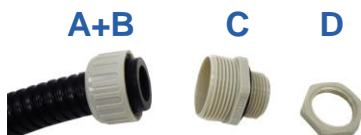

- C. Screw part C to the tube.

3 Installing the Fisheye Camera

- D. Thread the necessary wires and cables through the corrugated tube, plug the tube to the box and secure with part D.

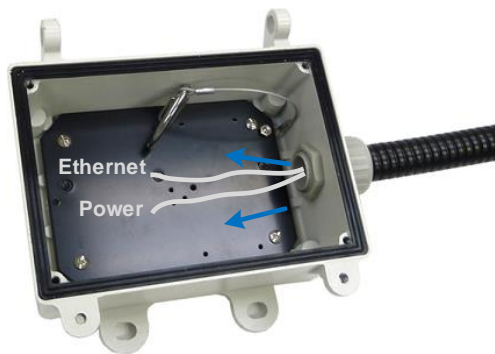

4. Thread the camera cable through the pendant tube (GV-Mount203, No. 2) and secure the tube to the end of the housing cap (GV-Mount903-1, No. 2) with M6 screws (GV-Mount903-1, No. 4).

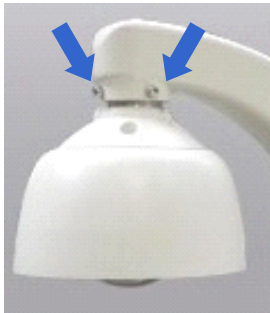

5. Hinge and hook the pendant tube to the junction box.



6. Connect the network, power and other cables to the camera.
7. Conceal the junction box with M5 screws (GV-Mount203, No. 3) using the torx wrench (GV-Mount203, No. 5).

3.12 Power Box Mount



Required accessories:

- GV-Mount912
- GV-Mount912-1 (only for GV-QFER12700)

The user needs to prepare

- Screws for securing the mounting plate to power box
-

Note: For GV-FER12700, users may be supplied with back plate A or B, as shown below, with the standard package:

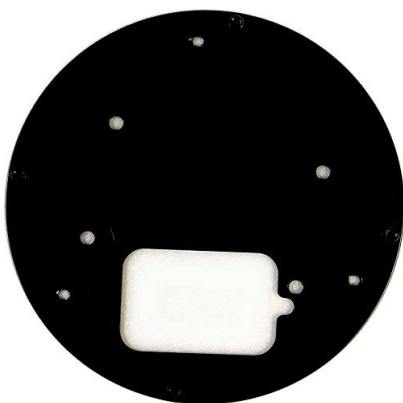

Back Plate A

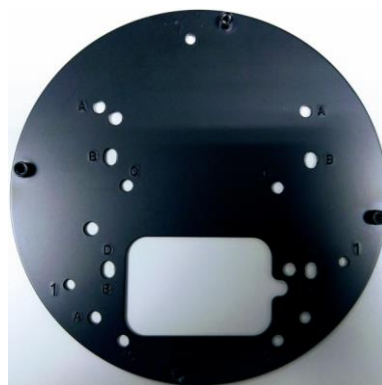

Back Plate B

- For back plate A, proceed to Step 1.
 - For back plate B, thread the camera cable through the back plate and power box, attach the back plate directly to the power box, as illustrated below, and proceed to Step 4.
-

3 Installing the Fisheye Camera

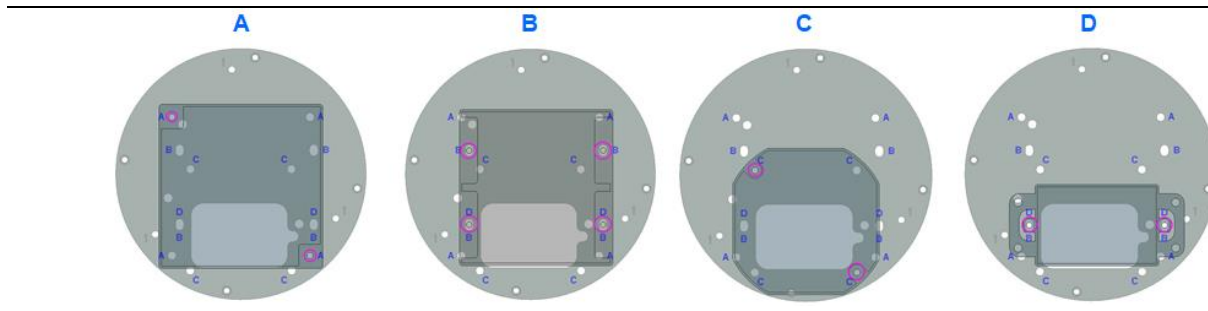

- Secure the mounting plate (GV-Mount912, No. 1) / GV-Mount912-1 (GV-Mount912-1, No. 1) to the power box with your own screws. Depending on the type of power box, use the holes indicated with the corresponding letter:

GV-Mount912

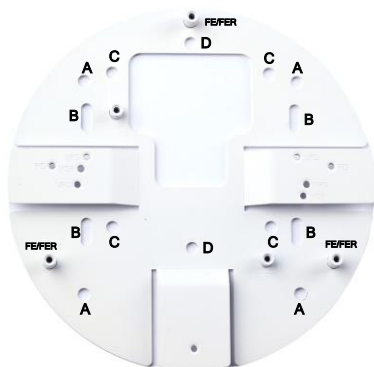

Type of Power Box	Hole
4" Square	A
Double Gang	B
4" Octagon	C
Single Gang	D

GV-Mount912-1



Type of Power Box	Hole
4" Square	A
Double Gang	B
4" Octagon	C
Single Gang	D

2. For **GV-FER12700**:

- A. Thread the camera cable through the camera back plate, the mounting plate, and the power box.
- B. Secure the back plate and the mounting plate with M3 screws (GV-Mount912, No. 2). Use the holes labeled as "FE/FER".

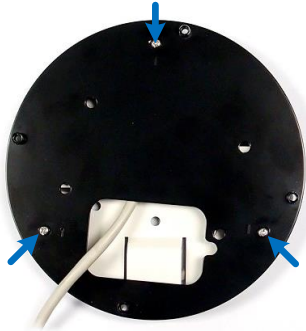

- C. Align the camera with the back plate and tighten the screws.
- D. Secure the camera cover.

3. For **GV-QFER12700**:

- A. Thread the camera cable through GV-Mount912-1 (GV-Mount912-1, No. 1) and the power box.
- B. Secure the camera to GV-Mount912-1 (GV-Mount912-1, No. 1) through the indicated holes with M4 screws (GV-Mount912-1, No. 3).



- C. Secure the camera cover.

3.13 Swan Neck Mount

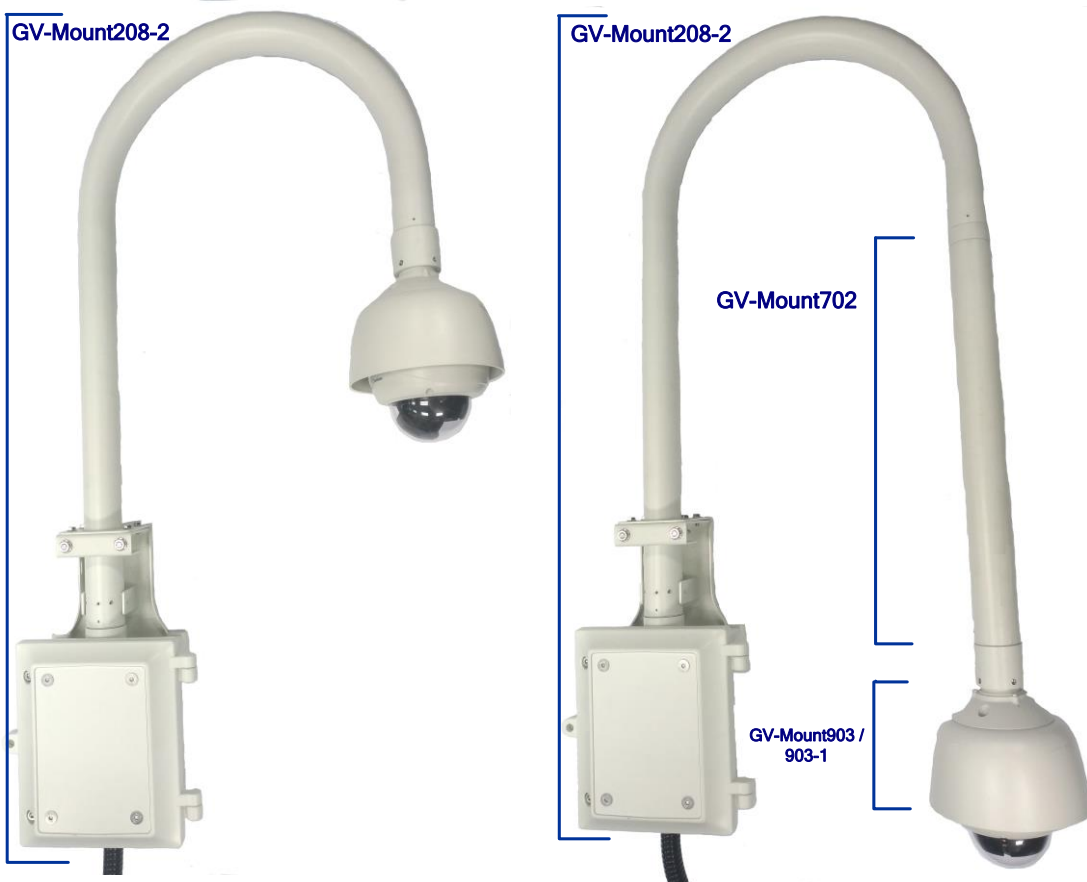

Required accessories:

- GV-Mount208-2
- GV-Mount903-1

The user needs to prepare:

- Screws for ceiling x 4
- Corrugated tube x 1 (3/4", \varnothing 26.0 ~ 26.5 mm)



- Adjustable wrench x 1

Optionally extend with:

- GV-Mount702
-

1. Loosen the indicated two screws of the junction box (GV-Mount208-2, No. 7) using No. 6 torx wrench (GV-Mount208-2, No. 4) and open the box cover.

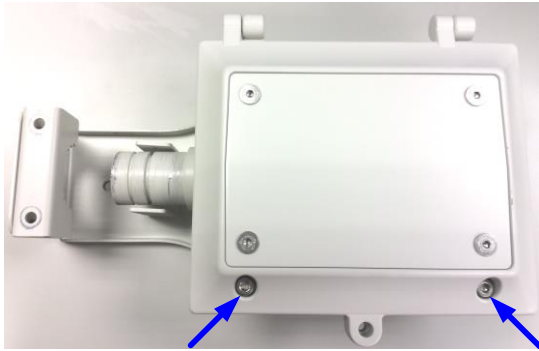

2. Loosen the 4 screws in the holes of the junction box using No. 6 torx wrench (GV-Mount208-2, No. 4) without removing them.

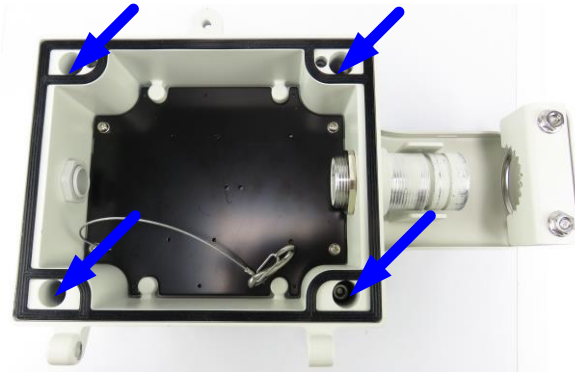

3. Turn over the junction box and loosen the four screws in the back with a Philips screwdriver to remove the supporting plate.

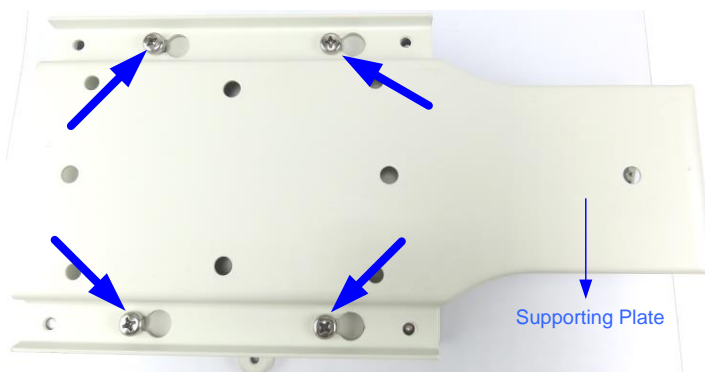

3 Installing the Fisheye Camera

4. Secure the supporting plate to the wall with the 4 self-prepared screws.

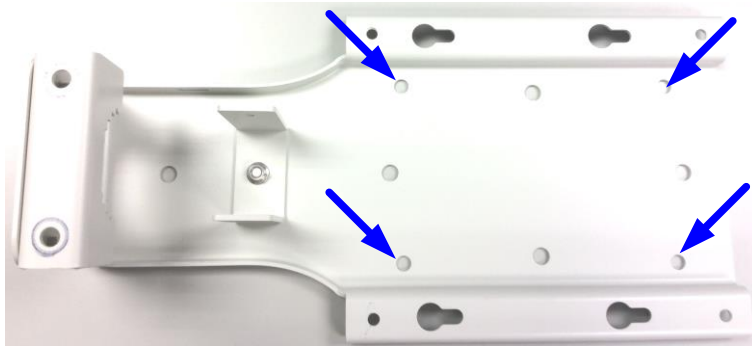

5. Hang the junction box onto the supporting plate. Slide the box sideways to lodge the 4 screws with the plate.

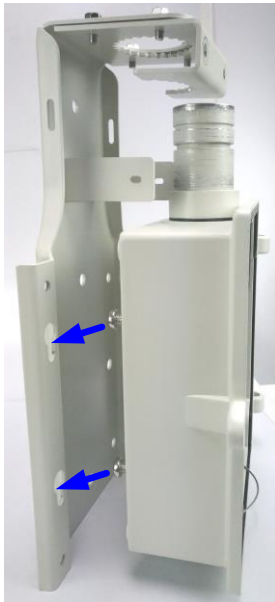

6. Fasten the 4 screws in the holes of the junction box. Refer to the figure in step 2.
7. Hinge and hook the box cover to the junction box.



8. Assemble the supplied corrugated tube connector with the self-prepared corrugated tube and the junction box.

A. Dismantle the supplied corrugated tube connector. You should have 4 parts.



B. Slide part A and part B to the self-prepared corrugated tube.

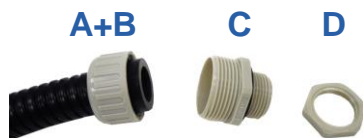

C. Screw part C to the tube.

D. Thread the power, network and other wires from the wall through the corrugated tube into the junction box and secure it with part D.

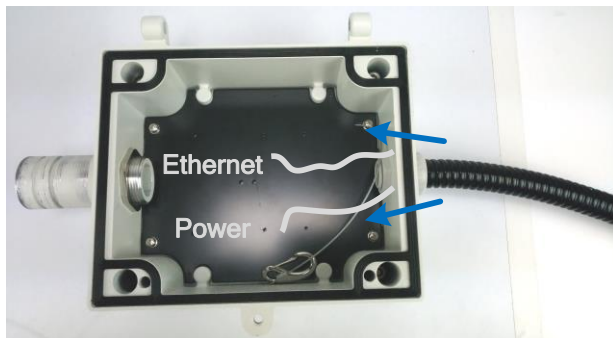

9. Connect the swan neck stainless tube (GV-Mount208-2, No. 5) with the junction box and fasten the washers (GV-Mount208-2, No. 6) on the two sides of the swan neck tube with No. 3 Torx Wrench (GV-Mount208-2, No. 2). Adjust the swan neck tube to suit your needs while you connect them.

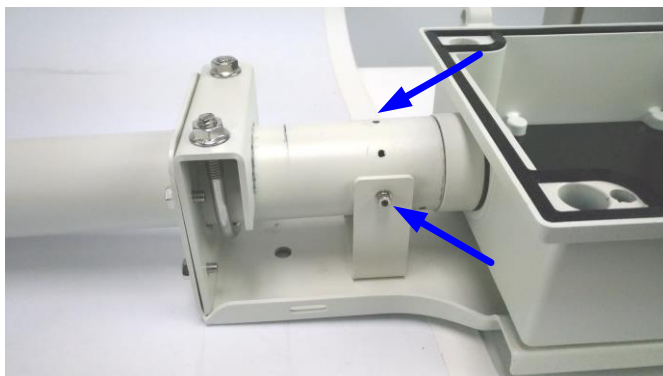

3 Installing the Fisheye Camera

10. Fasten the screws on the top of the swan neck with the self-prepared adjustable wrench.

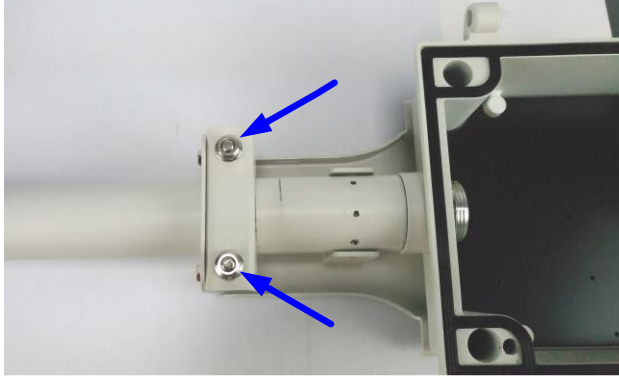

11. Secure the tube connector (GV-Mount208-2, No. 8) to the swan neck stainless tube with No.2 torx wrench (GV-Mount208-2, No. 1). Thread the wires and cables through the tube.

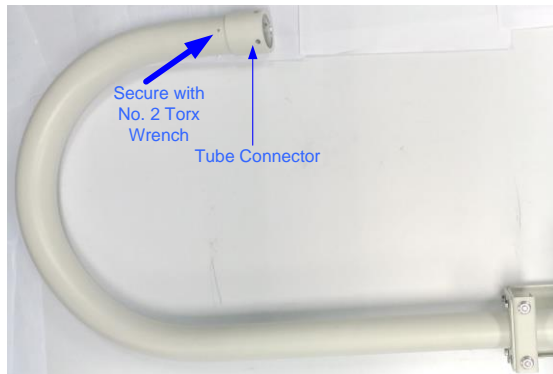

12. Assemble the tube connector (GV-Mount208-2, No. 8), housing cap (GV-Mount903-1, No.2) and then the dome housing (GV-Mount903-1, No.1) with M6 screws (GV-Mount903-1, No.4).

13. Thread the power, network and other wires through the dome housing.

14. Secure the box cover by fastening the 2 screws. Refer to the figure in step 1.

4. Installing the GV-IP Speed Dome

The instructions in this chapter only apply to **GV-SD2722-IR**, **SD4825-IR**, **SD4834-IR**, **GV-QSD5730-Outdoor**, and **QSD5731-IR**.

4.1 Assembling Outdoor IP Speed Dome with Pendant Tube



This installation method is only applicable to **GV-SD2722-IR / GV-SD4825-IR / GV-SD4834-IR / GV-QSD5730-Outdoor / GV-QSD5731-IR**.

Required Items

- GV-Mount210 / GV-Mount210-1

The user needs to prepare:

- Screws for wall x 4
-

4 Installing the GV-IP Speed Dome

1. Unscrew the back cover of the camera.



GV-SD Series



GV-QSD5730-Outdoor / GV-QSD5731-IR

2. Insert the micro SD card into the slot and secure the back cover of the camera.



GV-QSD5730-Outdoor / GV-QSD5731-IR

3. Place the wall pendant tube (GV-Mount210, No. 1) on the wall, and mark the position of the screw holes.

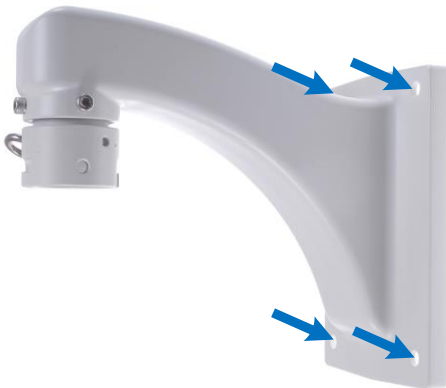

4. Drill holes on the wall, and secure the pendant tube to the wall with 4 self-prepared screws.

For GV-SD Series

5. Attach the safety lock of the camera to the pendant tube.



6. Thread the data cable through the pendant tube.



7. Attach the camera to the pendant tube, rotate the camera until it is locked into position, and secure the indicated screws.



4 Installing the GV-IP Speed Dome

8. Insert the screws (GV-Mount210, No. 2) and tighten with the M4 hex key supplied with the standard packing of the camera.

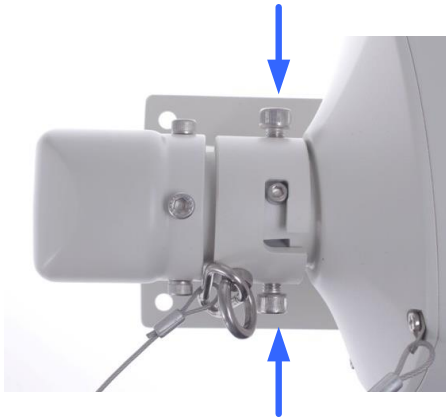

9. Thread the Ethernet cable through the waterproof rubber set as shown below.



Note: The size of RJ-45 connector must be within 14 mm to go through the waterproof rubber set.

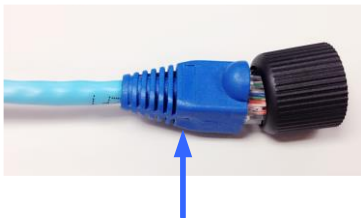

Unfit size of RJ45 Connector

For GV-QSD5730-Outdoor / GV-QSD5731-IR

6. Attach the safety lock of the connecting tube to the camera after securing the pendant cap to the pendant tube.

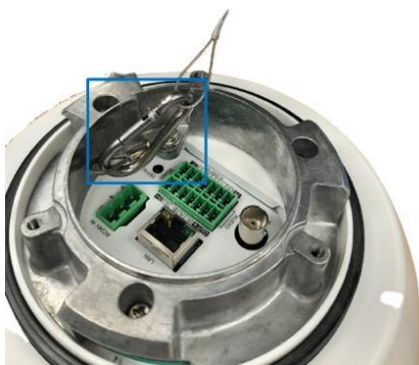

7. Attach the pendant cap to the camera and rotate until it is locked into position. Make sure the screw hole on the pendant cap aligns with one of the three screw holes on the base of the camera.
8. Secure the supplied M4 screw through the aligned screw hole.

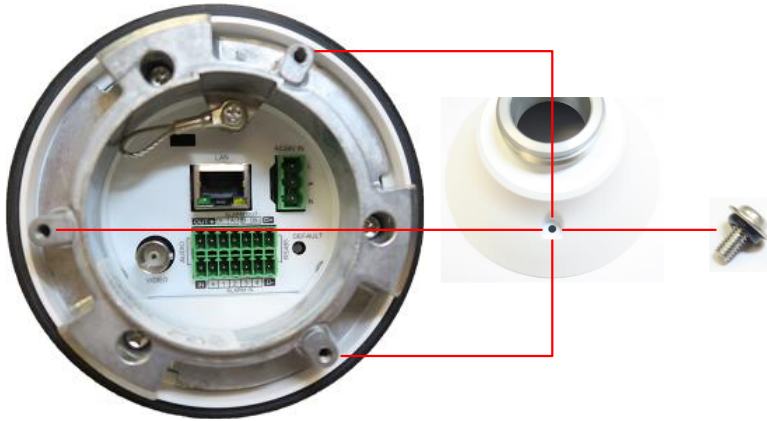

9. Insert the screws (GV-Mount210-1, No. 2) and tighten with the M4 hex key supplied with the standard packing of the camera.

4.2 Straight Tube Box Mount



This installation method is only applicable to **GV-SD2722-IR / GV-SD4825-IR / GV-SD4834-IR**.

Required accessories:

- GV-Mount105

The user needs to prepare:

- Screws for ceiling x 4
- Corrugated tube x 1 (3/4", \varnothing 26.0 ~ 26.5 mm)



Optionally extend with:

- GV-Mount702
-

1. Follow steps 1 to 2 in *4.1 Assembling Outdoor IP Speed Dome with Pendant Tube* to insert the SD card.
2. Secure the supporting plate (GV-Mount105, No. 3) to the ceiling with the 4 self-prepared screws.

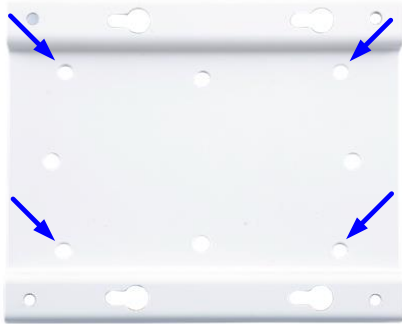

3. Fasten the 4 M8 (20 mm) screws (GV-Mount105, No. 11) to the back of the junction box (GV-Mount105, No. 1).

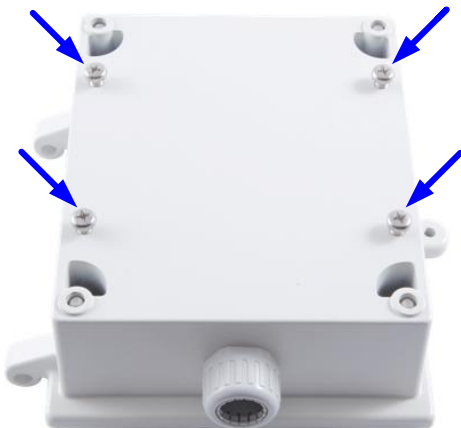

4. Hang the junction box onto the supporting plate. Slide the junction box sideways to lodge the 4 screws with the plate.

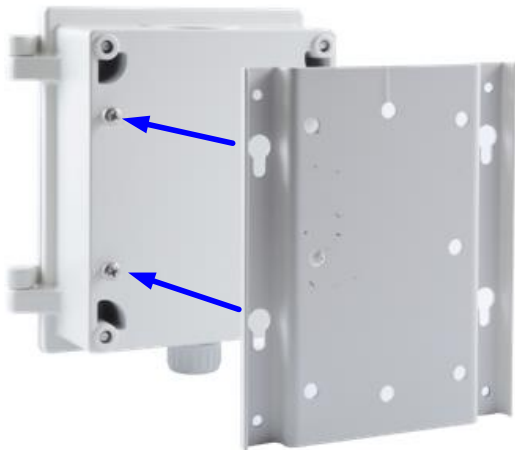

4 Installing the GV-IP Speed Dome

5. Fasten the 4 screws in the holes of the junction box using the supplied No. 6 hex key (GV-Mount105, No. 9).



6. Assemble the corrugated tube connector with the self-prepared corrugated tube.
 - A. Dismantle the corrugated tube connector from the junction box. You should have 3 components.

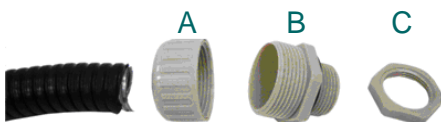

- B. Slide the corrugated tube connector to the self-prepared corrugated tube.

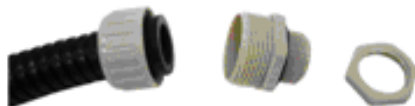

- C. Screw part B to the tube.
- D. Connect the corrugated tube to the box and secure with part C.

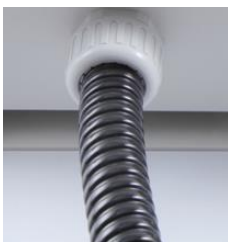

- E. Thread the necessary wires and cables through the corrugated tube.



7. Hinge and hook the box cover to the junction box.



8. Attach the anti-drop safety ring (GV-Mount105, No. 15) to the tube connector (GV-Mount105, No. 5).
9. Assemble the tube (GV-Mount105, No. 6), the housing cap (GV-Mount105, No. 5), and the box cover plate (GV-Mount105, No. 4) by rotating the parts together.



10. Make sure the tubes are properly screwed. Tighten the screws using the supplied No. 2 hex key (GV-Mount105, No. 8).



11. Follow steps 5 to 9 in *4.1 Assembling Outdoor IP Speed Dome with Pendant Tube* to secure the safety lock, attach the camera with the tube, and waterproof the cable.

4 Installing the GV-IP Speed Dome

12. Cut a line through the biggest hole of the waterproof rubber B (GV-Mount105, No. 13), and thread the camera data cable through the hole.

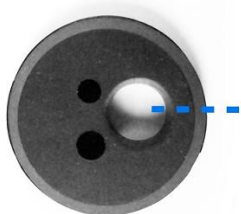

13. Embed the waterproof rubber onto the top of the box cover.



14. Connect the network, power and other cables to the camera.
15. Secure the box cover plate onto the box cover with M8 (16.2 mm) flat screws (GV-Mount105, No. 10).

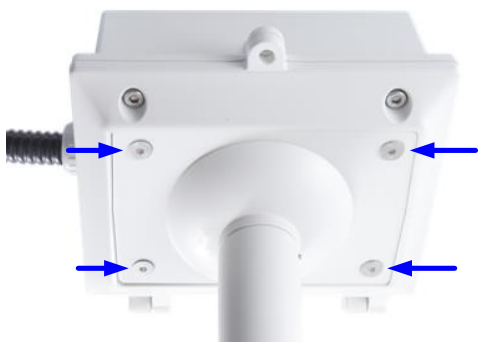

16. Secure the box cover by fastening the 2 screws at the corner with the No. 6 hex key.



4.3 Straight Tube Mount



This installation method is only applicable to **GV-SD2722-IR / GV-SD4825-IR / GV-SD4834-IR**.

Required accessories:

- GV-Mount104

The user needs to prepare:

- Screws for ceiling x 4

Optionally extend with:

- GV-Mount702
-

1. Follow step 1 in *4.1 Assembling Outdoor IP Speed Dome with Pendant Tube* to insert the SD card.

4 Installing the GV-IP Speed Dome

2. Attach the anti-drop safety ring (GV-Mount104, No. 6) to the tube connector (GV-Mount104, No. 2).
3. Assemble the tube (GV-Mount104, No. 3), the tube connector (GV-Mount104, No. 2), and the mounting bracket (GV-Mount104, No. 1) by rotating the parts together.

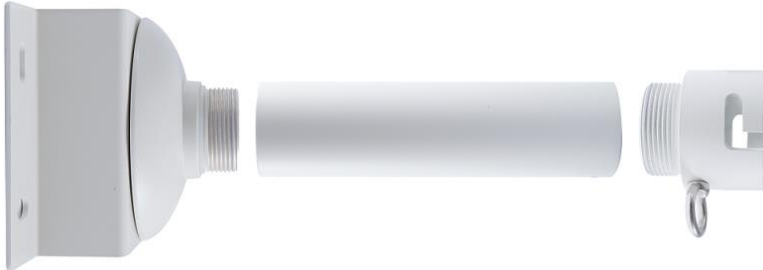

4. Make sure the tubes are properly screwed. Tighten the screws using the No. 2 hex key (GV-Mount104, No. 4).



5. Secure the assembled tube to the ceiling with 4 self-prepared screws
6. Attach the safety lock of the camera to the tube connector.



7. Thread the network, power and other cables through the tube, and connect the cables to the camera.
8. Waterproof the cable and attach the camera with the tube.

4.4 Convex Corner Mount



This installation method is only applicable to **outdoor GV-IP Speed Dome: GV-SD2722-IR**

Required accessories:

- GV-Mount210 - Pendant Tube
- GV-Mount300-1

The user needs to prepare:

- Screws for wall x 8

-
1. Assemble the camera with the pendant tube. See *4.1 Assembling Outdoor IP Speed Dome with Pendant Tube*.
 2. Follow steps 3 to 5 in *3.7 Convex Corner Mount* to assemble the mounting plates to the camera and secure the camera to the wall.
 3. Connect the network, power and other cables to the camera.

4.5 Convex Corner Box Mount



This installation method is only applicable to **GV-SD2722-IR / GV-SD4825-IR / GV-SD4834-IR**.

Required accessories:

- GV-Mount210
- GV-Mount501
- GV-Mount300-1

The user needs to prepare:

- Screws for ceiling x 8
- Corrugated tube x 1 (3/4", \varnothing 26.0 ~ 26.5 mm)



-
1. Follow step 1 in *4.1 Assembling Outdoor IP Speed Dome with Pendant Tube* to insert the SD card.

2. Connect the supporting plate of GV-Mount501 to GV-Mount300-1 by fastening the 4 M8 30-mm screws and plain washers (supplied with GV-Mount300-1), and fasten the 4 M8 (30-mm) screws and plain washers.

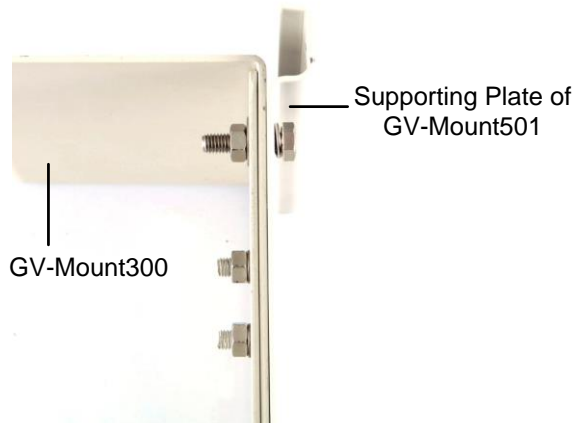

3. Follow steps 3 to 7 in *4.2 Straight Tube Box Mount* to assemble the junction box.
4. Follow steps 5 to 9 in *4.1 Assembling Outdoor IP Speed Dome with Pendant Tube* to secure the safety lock, attach the camera to the pendant tube (GV-Mount210, No.1), and waterproof the data cable.
5. Cut a line through the biggest hole of the waterproof rubber B (GV-Mount501, No. 10), and thread the camera data cable through the hole.

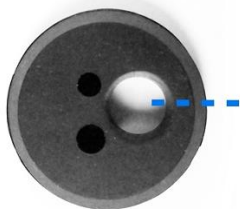

6. Embed the waterproof rubber onto the box cover.



4 Installing the GV-IP Speed Dome

7. Secure the pendant tube onto the box cover with the 4 supplied M8 (20 mm) screws (GV-Mount501, No. 5) and 4 plain washers (GV-Mount501, No. 9).

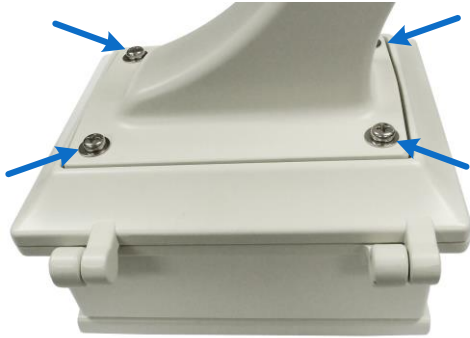

8. Secure the box cover by fastening the 2 screws at the corner with the No. 6 hex key.



4.6 Concave Corner Mount



This installation method is only applicable to **GV-SD2722-IR**

Required accessories:

- GV-Mount210 - Pendant Tube
- GV-Mount310-1

The user needs to prepare:

- Screws for wall x 8

-
1. Assemble the camera with the pendant tube. See *4.1 Assembling Outdoor IP Speed Dome with Pendant Tube*.
 2. Follow steps 2, 4 and 5 in *3.9 Concave Corner Mount* to assemble the mounting plates and secure the camera to the wall.
 3. Connect the network, power and other cables to the camera.

4.7 Pole Mount



This installation method is only applicable to **GV-SD2722-IR**.

Required accessories:

- GV-Mount210 - Pendant Tube
- GV-Mount400-1 or GV-Mount410-1

-
1. Assemble the camera with the pendant tube. See *4.1 Assembling Outdoor IP Speed Dome with Pendant Tube*.
 2. Follow step 2 in *3.10 Pole Mount* to secure the pole mount bracket.
 3. Follow step 4 in *3.10 Pole Mount* to secure the camera to the pole.
 4. Connect the network, power and other cables to the camera.

4.8 Pole Box Mount



This installation method is only applicable to **GV-SD2722-IR / GV-SD4825-IR / GV-SD4834-IR**.

Required accessories:

- GV-Mount210
- GV-Mount501
- GV-Mount400-1 or GV-Mount410-1

The user needs to prepare:

- Screws for ceiling x 4
- Corrugated tube x 1 (3/4", \varnothing 26.0 ~ 26.5 mm)



-
1. Follow step 1 in *4.1 Assembling Outdoor IP Speed Dome with Pendant Tube* to insert the SD card.

4 Installing the GV-IP Speed Dome

2. Connect the supporting plate of GV-Mount501 to GV-Mount400-1 or GV-Mount410-1 by fastening the 4 M8 30-mm screws and plain washers (supplied with GV-Mount400-1 or GV-Mount410-1), and fasten the 4 M8 (30-mm) screws and plain washers.



3. Follow steps 3 to 7 in *4.2 Straight Tube Box Mount* to assemble the junction box.
4. Follow steps 5 to 9 in *4.1 Assembling Outdoor IP Speed Dome with Pendant Tube* to secure the safety lock, attach the camera to the pendant tube (GV-Mount210, No.1), and waterproof the data cable.
5. Cut a line through the biggest hole of the waterproof rubber B (GV-Mount501, No. 10), and thread the camera data cable through the hole.

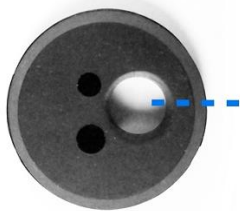

6. Embed the waterproof rubber onto the top of the box cover.



7. Secure the pendant tube onto the box cover with the 4 M8 (30-mm) screws (GV-Mount501, No. 5) and 4 plain washers (GV-Mount501, No. 9) supplied.

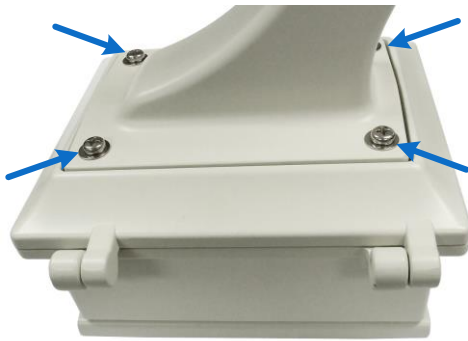

8. Secure the box cover by fastening the 2 screws at the corner with the No. 6 hex key.



4.9 Swan Neck Mount



This installation method is only applicable to **GV-SD2322-IR / GV-SD4825-IR / GV-SD4834-IR**.

Required accessories:

- GV-Mount208-3

The user needs to prepare:

- Screws for ceiling x 4
- Corrugated tube x 1 (3/4", \varnothing 26.0 ~ 26.5 mm)



- Adjustable wrench x 1

Optionally extend with:

- GV-Mount702
-

1. Follow step 1 in *4.1 Assembling Outdoor IP Speed Dome with Pendant Tube* to insert the SD card.
2. Loosen the indicated two screws of the junction box (GV-Mount208-3, No. 6) using the No. 6 hex key (GV-Mount208-3, No. 4) and open the box cover.

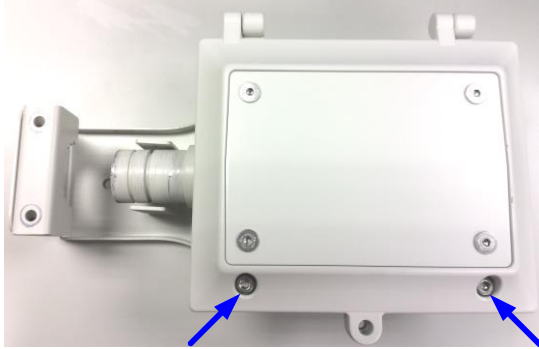

3. Loosen the 4 screws in the holes of the junction box using No. 6 hex key (GV-Mount208-3, No. 4) without removing them.

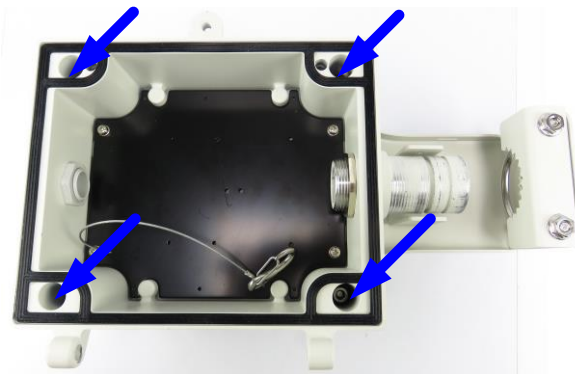

4. Turn over the junction box and loosen the four screws in the back with a screwdriver to remove the supporting plate.

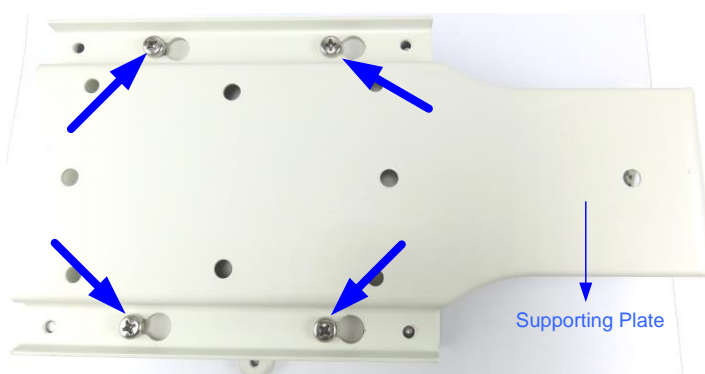

4 Installing the GV-IP Speed Dome

5. Secure the supporting plate to the wall with the 4 self-prepared screws.

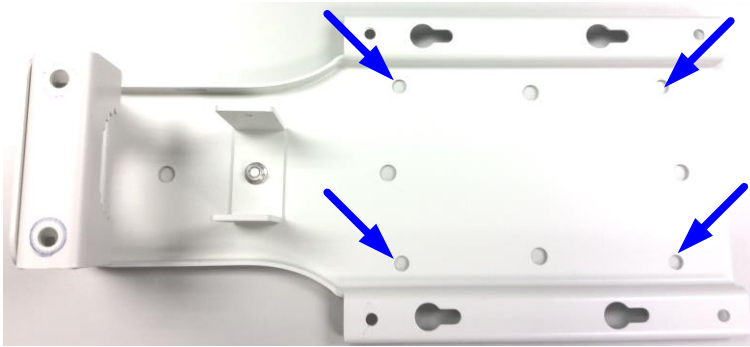

6. Hang the junction box onto the supporting plate. Slide the box sideways to lodge the 4 screws with the plate.

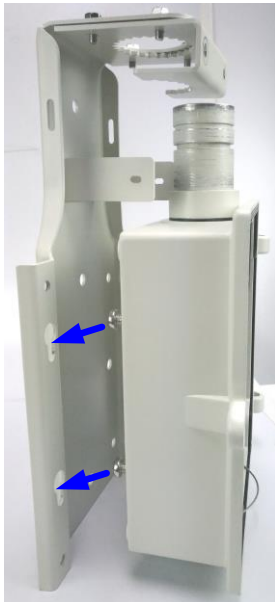

7. Fasten the 4 screws in the holes of the junction box.

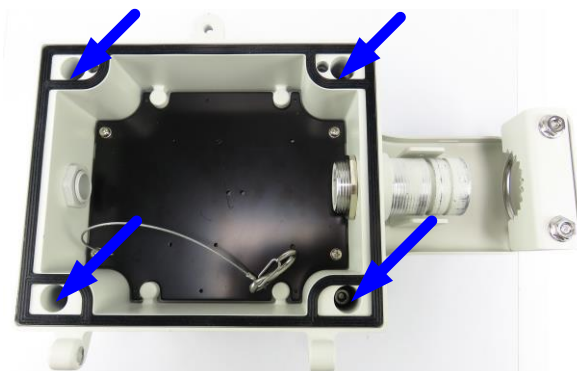

- Hinge and hook the box cover to the junction box.



- Assemble the supplied corrugated tube connector with the self-prepared corrugated tube and the junction box.

- Dismantle the supplied corrugated tube connector. You should have 4 parts.



- Slide part A and part B to the self-prepared corrugated tube.



- Screw part C to the tube.
- Thread the power, network and other wires from the wall through the corrugated tube into the junction box and secure it with part D.

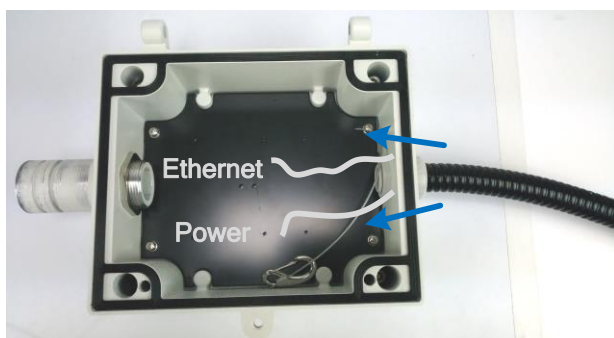

4 Installing the GV-IP Speed Dome

10. Connect the swan neck stainless tube (GV-Mount208-3, No. 5) with the junction box and fasten the washers on the two sides of the swan neck tube with the No. 3 hex key (GV-Mount208-3, No. 2). Adjust the swan neck tube to suit your needs while you connect them.

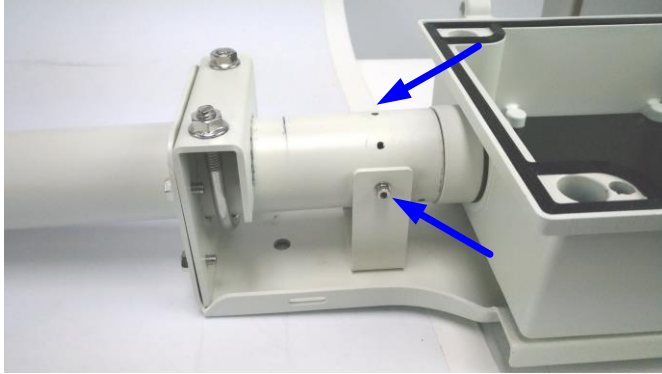

11. Fasten the screws on the top of the swan neck with a self-prepared adjustable wrench.

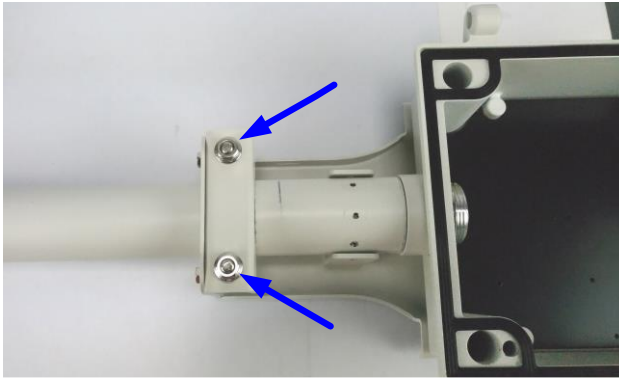

12. Attach the anti-drop safety ring (GV-Mount208-3, No. 9) to the tube connector (GV-Mount208-3, No. 8).
13. Secure the tube connector (GV-Mount208-3, No. 8) to the swan neck stainless tube.



14. Attach the safety lock of the camera to the anti-drop safety ring.



15. Thread the wires and cables through the tube.

16. Attach the camera onto the tube connector, rotate the camera until it is locked into position



17. Insert and tighten the indicated screws (GV-Mount208-3, No. 2).



18. Secure the junction box cover.



5. Installing the Target Bullet / LPR Camera

The instructions in this chapter only apply to **GV-EBL 4702** of the Target Bullet Camera Series and **GV-LPC2210 / LPC2011** of the IP LPR Camera Series.

5.1 Note for Closing the Bullet Camera Cover

To ensure that the camera performs its full capacity against water and dust, tightly close and lock the camera cover as indicated below.



5.2 Convex Corner Mount

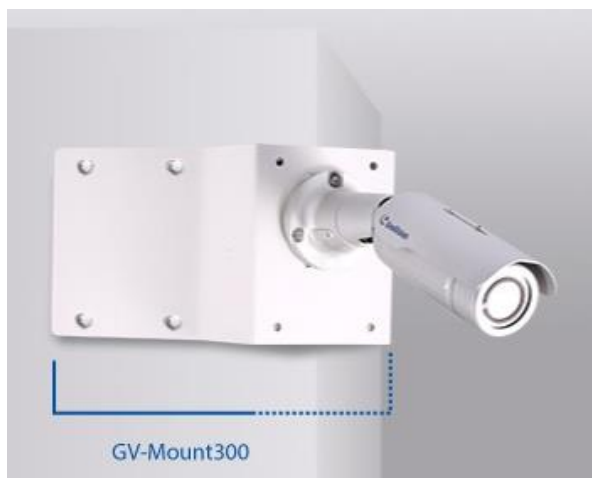

Required accessories:

- GV-Mount300-1

The user needs to prepare:

- Screws for wall x 8
-

5 Installing the Target Bullet / LPR Camera

1. Assemble the mounting plates (GV-Mount300-1, No. 1), slide in the plain washer (GV-Mount300-1, No. 4), then the split washer (GV-Mount300-1, No. 5), and secure with the screw cap (GV-Mount300-1, No. 6).

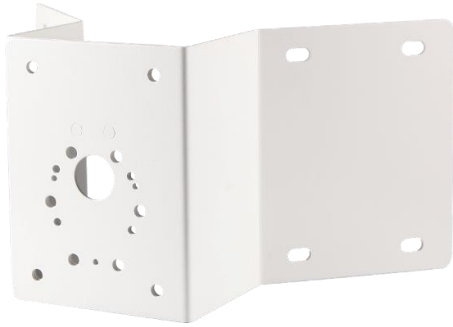

2. Assemble the camera or the back plate with the mounting plates. From the front, insert the screw for mounting kit (supplied with the camera). From the backside, secure using the nut for mounting (supplied with the camera).



Front View

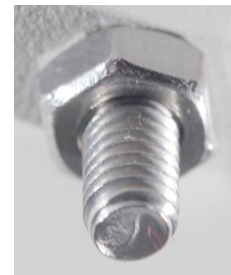

Back View

3. Secure the mounting plates to the wall with 8 self-prepared screws.

5.3 Concave Corner Mount



Required accessories:

- GV-Mount310-1

The user needs to prepare:

- Screws for wall x 8
-

1. Assemble the mounting plates (GV-Mount310-1, No. 1), slide in the plain washer (GV-Mount310-1, No. 3), then the split washer (GV-Mount310-1, No. 4), and secure them with the screw cap (GV-Mount310-1, No. 5).

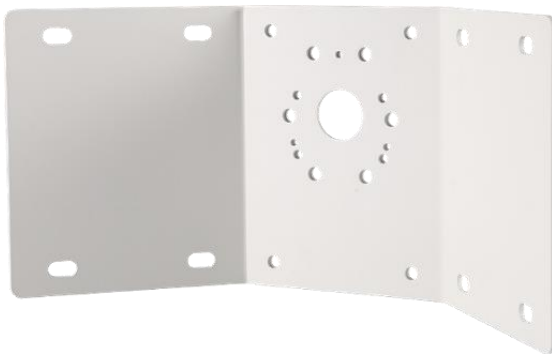

5 Installing the Target Bullet / LPR Camera

2. Assemble the camera or the back plate with the mounting plates. From the front, insert the screw for mounting kit (supplied with the camera). From the backside, secure using the nut for mounting (supplied with the camera).



Front View

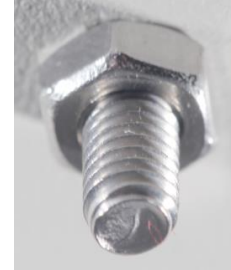

Back View

3. Secure the mounting plates to the wall with 8 self-prepared screws.

5.4 Pole Mount



Required accessories:

- GV-Mount400-1 / 410-1
-

1. Assemble the camera or the back plate with the mounting bracket. From the front, insert the screw for mounting kit (supplied with the camera). From the backside, secure using the nut for mounting (supplied with the camera).



Front View

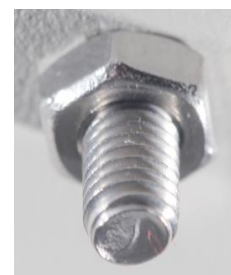

Back View

5 Installing the Target Bullet / LPR Camera

2. Secure the mounting bracket to the pole using 3 steel straps (GV-Mount400-1 / 410-1, No. 2). Rotate the screw on the strap to adjust its size.



6. Installing the Box Camera with the Housing

The instructions in this chapter only apply to **GV-Housing102** and **Housing103**.

6.1 Note for Installing the Housing

The GV-Housing102 / 103 support indoor or outdoor installation of GV-BX Series. The supported GV-BX models are as below:

GV-Housing102	GV-Housing103
GV-BX2600-FD	GV-BX2600-FD
GV-BX2700-FD	GV-BX2700-FD
GV-BX4700-3V	GV-BX4700-3V
GV-BX8700-FD	GV-BX8700-FD
	GV-BX12201

For the following GV-BX Series with GV-Housing102 / 103, the shorter the focal length of camera lens you adjust, the more possibly the camera captures the housing box cover.

GV-Housing102	GV-Housing103
GV-BX2700-3V (3 ~ 10.5 mm)	GV-BX12201 (4.1 ~ 9 mm)
GV-BX4700-3V (3 ~ 10.5 mm)	GV-BX2700-3V (3 ~ 10.5 mm)
GV-BX4700-8F (2.8 mm)	GV-BX4700-3V (3 ~ 10.5 mm)
GV-BX5700-3V (3.6 ~ 10 mm)	GV-BX5700-3V (3.6 ~ 10 mm)

For proper live view, you can adjust the position of camera and the focal length of camera lens as illustrated below.

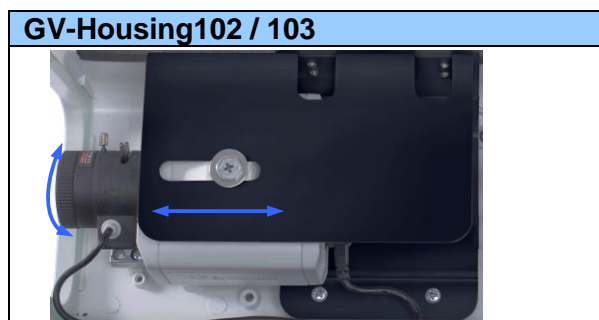

6.2 Assembling the Box Camera with the Housing

6.2.1 GV-Housing102



Required accessories:

- GV-Housing102 (with heater and fan)

The user needs to prepare:

- Ethernet, power, audio and I/O cables, etc for the camera
 - Silicon rubber to seal the camera
 - Mini USB cable with the connector of dimensions 9.6 x 7.6 mm or below for the camera (Optional)
 - Power wires for power board on the GV-Housing102 (24V AC / 12V DC input)
-

1. Unscrew the housing box (GV-Housing102, No. 1) with torx wrench (GV-Housing102, No. 8).



2. Remove the two black caps and the stoppers from the bottom of housing box.



3. Thread all the required cables through the supporting tube (GV-Housing102, No. 2) and then the two black caps as below. To ensure later installation, allocate the cables to the two black caps properly.

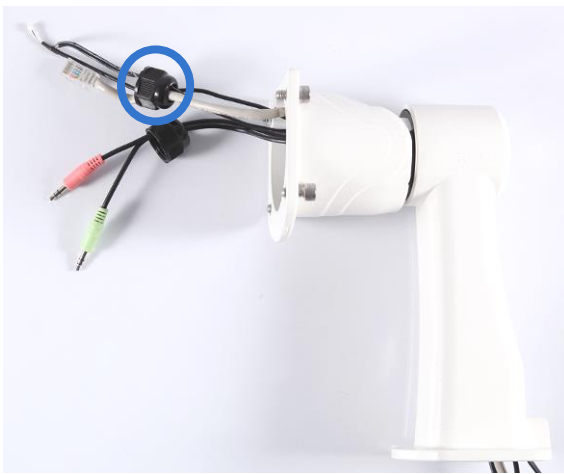

Note:

1. You need to use an Ethernet cable without RJ-45 connector to go through the housing box.
 2. For the mini USB cable (if required), you need to use the type with connector of dimensions 9.6 x 7.6 mm or below to go through the housing box.
-

4. Thread the cables through the holes at the bottom of the housing box and install the RJ-45 connector on the Ethernet cable.



6 Installing the Box Camera with the Housing

5. Assemble the two black plates (GV-Housing102, No. 13) with four M4 (8mm) screws (GV-Housing102, No. 11).

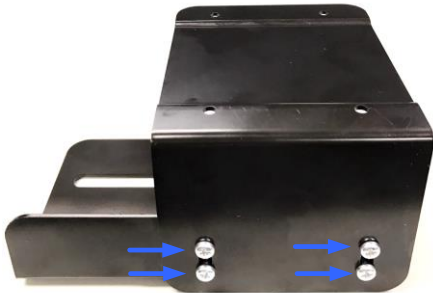

6. Assemble the short screw (GV-Housing102, No. 5) with M5 plain washer (GV-Housing102, No. 7) and secure the camera on the black plate.



7. Install the black plate with the camera on the housing box. Line up the black plate with four M4 (5mm) screws (GV-Housing 102, No. 12) and secure the four screws on the housing box.

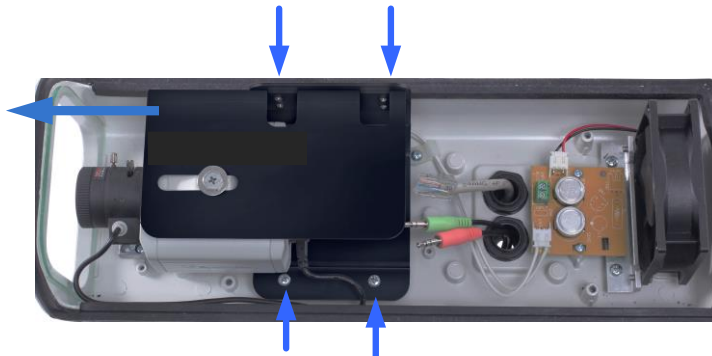

8. Connect all the required cables to the camera and the power board.

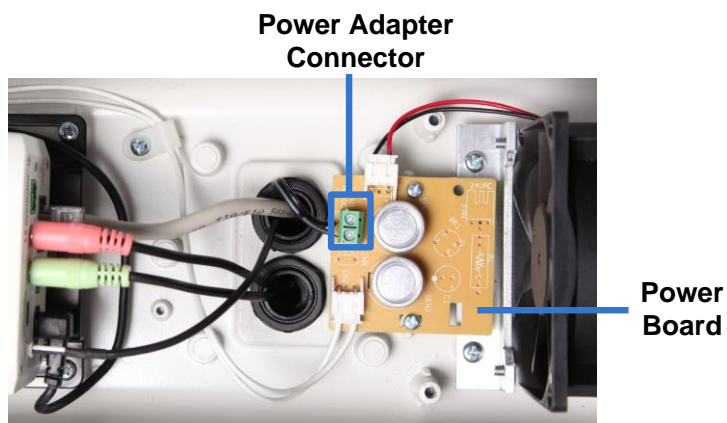

Note: Make sure the Power Adapter wires are connected to the correspondent electrodes labeled on the power board. Note this is only for the Power Adapter from GeoVision. If you are using different power adapter, the wires may have different colors.

- Black wire: negative electrode
 - Black with white stripes wire: positive electrode
-

9. Tighten the black cap on the bottom of housing box. To waterproof the housing box, apply silicon rubber to fill the gap between the cables and the black caps.

6 Installing the Box Camera with the Housing



10. Secure the supporting tube on the bottom of housing box.

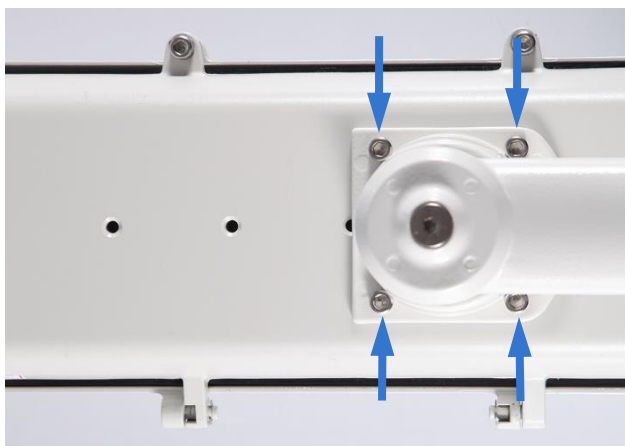

11. Mark the installation site, drill four holes and secure the housing box to the wall using the supplied screw anchors (GV-Housing102, No. 3), M5 screws (GV-Housing102, No. 4) and four plain washers (GV-Housing102, No. 6).



12. Adjust the camera to ensure proper live view:

- A. Access the live view of the camera. For the models supporting varifocal lens, check if the housing box cover is on the scene when adjusting the camera. For details, see *Note for Installing the Box Camera* earlier in this chapter.

- B. Based on the live view, adjust the camera's position and the focal length of camera lens.
- C. Use the torx wrench to adjust the joint angle of the housing box if necessary.

13. After the silicon rubber is dry, apply the supplied sticker in the housing box cover to paste the silica gel bag (GV-Housing102, No. 9) as below.



14. Secure the housing box cover with torx wrench.

Note: Make sure you conceal the silica gel bag in the housing box within two minutes of exposing to the open air.

6.2.2 GV-Housing103



Required accessories:

- GV-Housing103 (with 6 IR LEDs)

The user needs to prepare:

- Ethernet, audio and I/O cables, etc for the camera
-

1. Unscrew the housing box (GV-Housing103) with the hex key (GV-Housing103, No. 6).

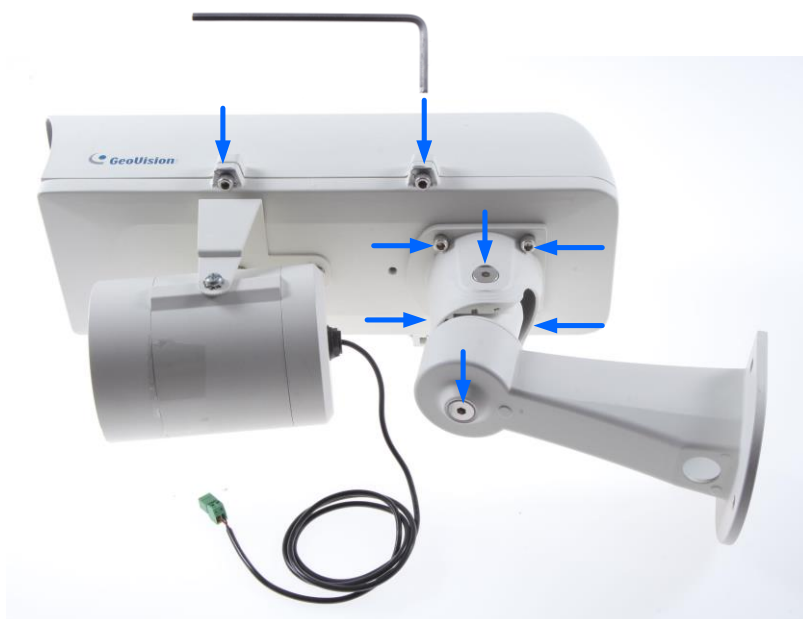

2. Open the housing box, assemble the 1/4" screw (GV-Housing103, No. 3) with tooth lock washer (GV-Housing103, No. 5), and secure the camera on the black plate.

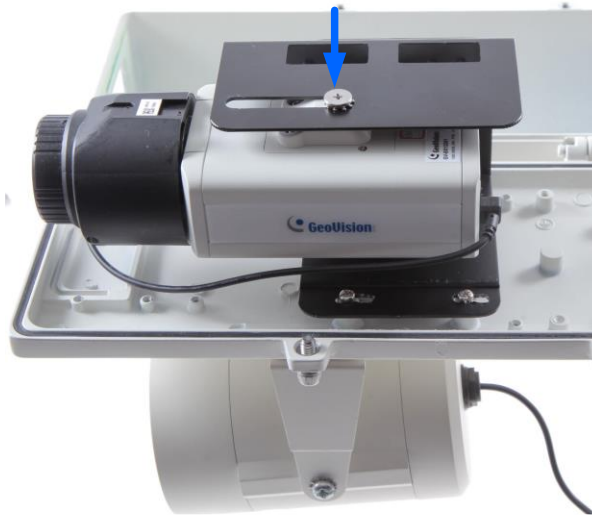

3. Thread the adapter wire (GV-Housing103, No. 8) through the supporting rack.



6 Installing the Box Camera with the Housing

4. Disintegrate the conduit connectors. Each connector should have 4 parts. Part 4 and 8 were built in the GV-Hosing103 box.

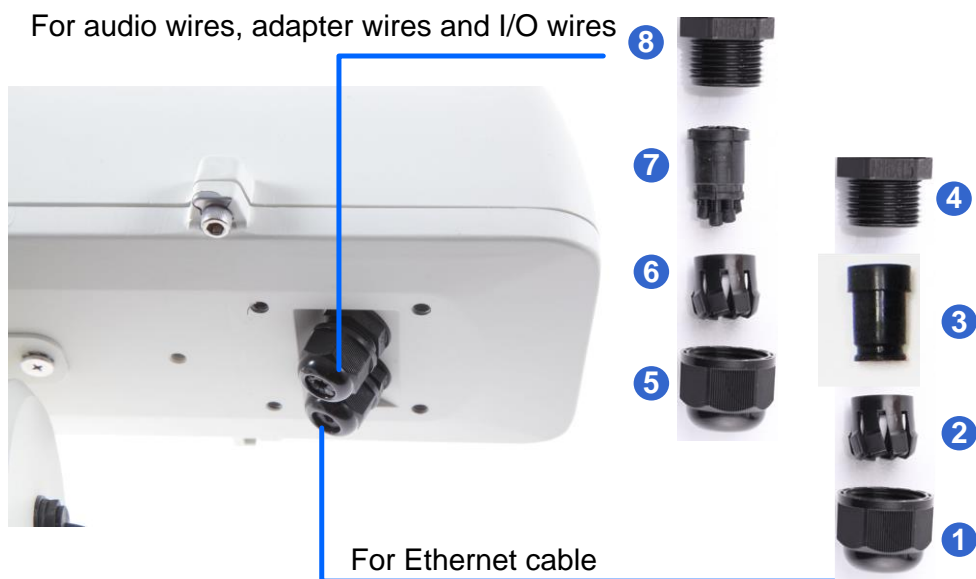

5. Thread all the required cables through the conduit connectors.



- A. Thread the Ethernet cable through part 1, 2, 3 and 4 of the conduit connector at the bottom of the housing box and install the RJ-45 connector on the Ethernet cable.

Note: You need to use an Ethernet cable without RJ-45 connector to go through the housing box.



B. Thread the audio wires (optional), adapter wires and I/O wires (optional) through part 5, 6, 7 and 8 of the conduit connector.

- For part 7, there are 8 holes each labeled with its diameter. Remove the plugs and push the wires to the corresponding hole listed below:
- There are 7 wires and 8 holes, keep the last plug in the connector to ensure waterproofing quality.

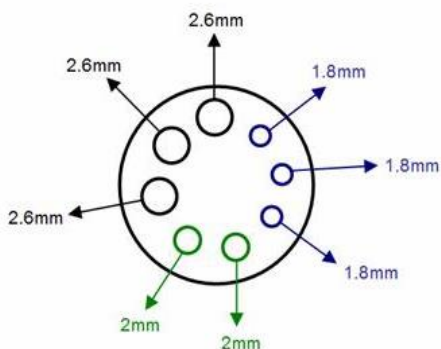

2.6 mm: Audio, BNC
 2 mm: DC12V / AC24V
 1.8 mm: DIDO

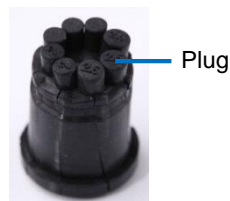

Tip:

1. To make the threading easier, it is advised to thread the wires in the order described above.
 2. Use a pair of pliers to help you pull the wires through GV-Hosing103.
-

6. Connect all the required cables to the camera.

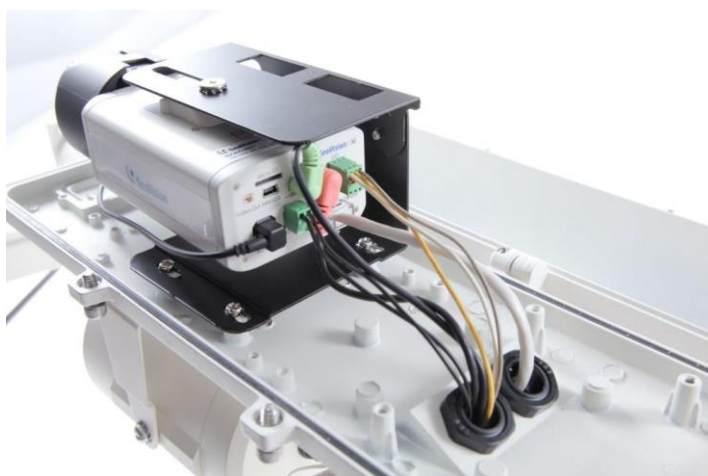

6 Installing the Box Camera with the Housing

7. Integrate the conduit connectors and tighten them on the bottom of the housing box.

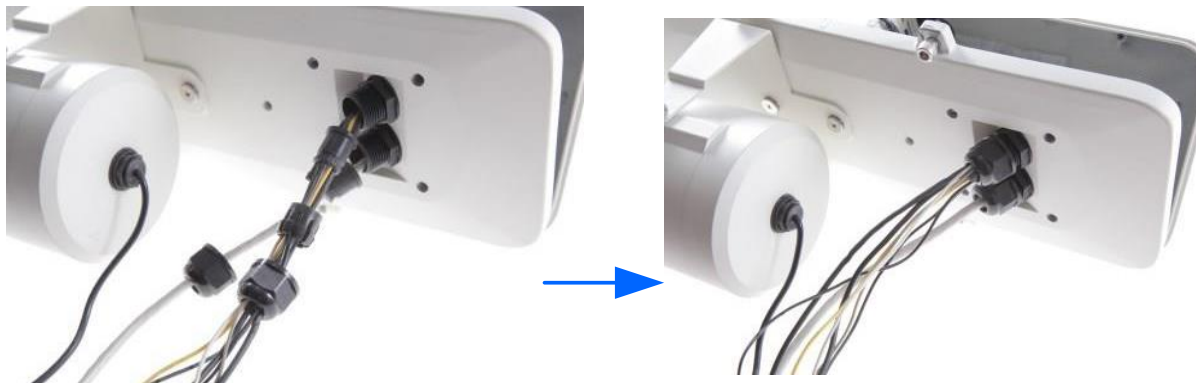

8. Thread the IR LED cable separately and all the others through the supporting rack.

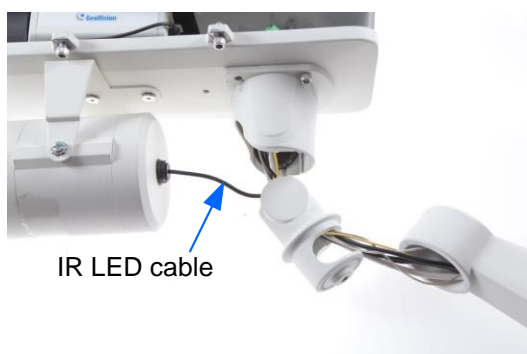

9. Secure the supporting rack with the hex key.
10. Mark the installation site, drill three holes and secure the housing box to the wall using the supplied screw anchors (GV-Housing103, No. 2), screws (GV-Housing103, No. 1) and three plain washers (GV-Housing103, No. 4).



11. Adjust the camera to ensure proper live view:

- A. Access the live view of the camera. For the models supporting varifocal lens, check if the housing box cover is on the scene when adjusting the camera. For details, see *Note for Installing the Box Camera* earlier in this chapter.
- B. Based on the live view, adjust the camera's position and the focal length of camera lens.
- C. Use the hex key to adjust the joint angle of the housing box if necessary.

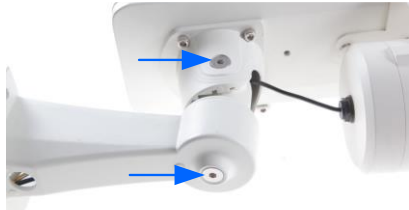

12. Paste the silica gel bag (GV-Housing103, No. 7) as below.



13. Secure the housing box cover with hex key.

Note: Make sure you conceal the silica gel bag in the housing box within two minutes of exposing to the open air.

6.3 Convex Corner Mount



Required accessories:

- GV-Mount300-1

The user needs to prepare:

- Screws for wall x 8
-

1. Assemble the mounting plates (GV-Mount300-1, No. 1), slide in the plain washer (GV-Mount300-1, No. 4), then the split washer (GV-Mount300-1, No. 5), and secure with the screw cap (GV-Mount300-1, No. 6).



2. Assemble the housing box with the mounting plates:
 - A. Thread the camera cables through the mounting plates.
 - B. Slide three 25 mm M8 screws (GV-Mount300-1, No. 3) from front and secure from the backside using plain washer (GV-Mount300-1 No. 4), split washer (GV-Mount300-1, No. 5) and screw cap (GV-Mount300-1, No. 6).



3. Secure the plates to the wall with 8 self-prepared screws.

6.4 Concave Corner Mount



Required accessories:

- GV-Mount310-1

The user needs to prepare:

- Screws for wall x 8
-

1. Assemble the mounting plates (GV-Mount310-1, No. 1), slide in the plain washer (GV-Mount310-1, No. 4), then the split washer (GV-Mount310-1, No. 5), and secure them with the screw cap (GV-Mount310-1, No. 6).



2. Assemble the camera with the mounting plates.
 - A. Thread the camera cable through the mounting plates.
 - B. Slide three 25 mm M8 screws for (GV-Mount310-1, No. 3) from front and secure from the backside using plain washer (GV-Mount310-1, No. 4), split washer (GV-Mount310-1, No. 5) and screw cap (GV-Mount310-1, No. 6).

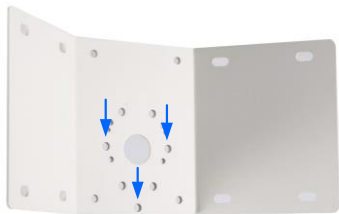

3. Secure the plates to the wall with 8 self-prepared screws.

6.5 Pole Mount



Required accessories:

- GV-Mount400-1 / 410-1
-

1. Assemble the camera with the mounting bracket (GV-Mount400-1 / 410-1, No.1).
 - A. Thread the camera cables through the mounting bracket.
 - B. Slide three 25 mm M8 screws (GV-Mount400-1 / 410-1, No. 4) from the front and secure from the backside using plain washer (GV-Mount400-1 / 410-1, No. 5), split washer, (GV-Mount400-1 / 410-1, No. 6) and M8 screw cap (GV-Mount 400-1 / 410-1, No. 7).



2. Secure the mounting bracket to the pole using 3 steel straps (GV-Mount400-1 / 410-1, No. 2). Rotate the screw on the strap to adjust its size.



7. Installing the IP LPR Camera

The instructions in this chapter only apply to **GV-LPC1200**, **LPC2011**, and **LPC2210**.

7.1 Convex Corner Mount



Required accessories:

- GV-Mount300-1

The user needs to prepare:

- Screws for wall x 8

-
1. Assemble the mounting plates (GV-Mount300-1, No. 1), slide in the plain washer (GV-Mount300-1, No. 4), then the split washer (GV-Mount300-1, No. 5), and secure with the screw cap (GV-Mount300-1, No. 6).

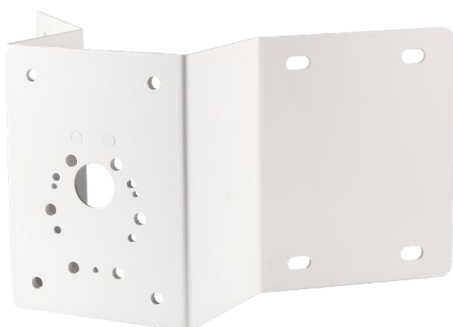

2. Assemble the camera with the mounting plates.
 - A. Thread the camera cable through the mounting plates.
 - B. Slide the 30 mm M8 screws (GV-Mount300-1, No. 2) from front and secure from the backside using plain washer (GV-Mount300-1, No. 4), split washer (GV-Mount300-1, No. 5) and screw cap (GV-Mount300-1, No. 6).



Backside View

3. Secure the plates to the wall with 8 self-prepared screws.

7.2 Concave Corner Mount



Required accessories:

- GV-Mount310-1

The user needs to prepare:

- Screws for wall x 8
-

1. Assemble the mounting plates (GV-Mount310-1, No. 1), slide in the plain washer (GV-Mount310-1, No. 3), then the split washer (GV-Mount310-1, No. 4), and secure them with the screw cap (GV-Mount310-1, No. 5).

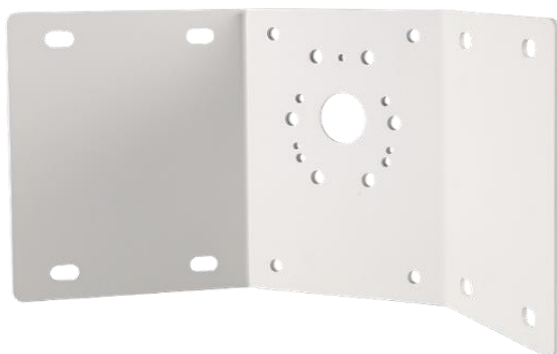

2. Assemble the camera with the mounting plates.
 - A. Thread the camera cable through the mounting plates.
 - B. Slide the 30 mm M8 screws (GV-Mount310-1, No. 2) from front and secure from the backside using plain washer (GV-Mount310-1, No. 3), split washer (GV-Mount310-1, No. 4) and screw cap (GV-Mount300-1, No. 5).



3. Secure the plates to the wall with 8 self-prepared screws.

7.3 Pole Mount



Required accessories:

- GV-Mount400-1 / 410-1
-

1. Assemble the camera with the mounting bracket (GV-Mount400-1 / 410-1, No.1).
 - A. Thread the camera cable through the mounting bracket.
 - B. Slide the 30 mm M8 screws (GV-Mount400-1 / 410-1, No. 3) from the front and secure from the backside using plain washer (GV-Mount400-1 / 410-1, No. 5), split washer, (GV-Mount400-1 / 410-1, No. 6) and M8 screw cap (GV-Mount400-1 / 410-1, No. 7).



Backside View

2. Secure the mounting bracket to the pole using 3 steel straps (GV-Mount400-1 / 410-1, No. 2). Rotate the screw on the strap to adjust its size.



8 Installing the Mini Fixed Dome

The instructions in this chapter only apply to **GV-MFD2700**.

8.1 Wall Mount Bracket



Required accessories:

- GV-Mount918
-

1. Take the wall mount bracket (GV-Mount918, No. 1) and make 2 marks on the wall for screw anchors.



2. Drill the marks and insert 2 screw anchors (GV-Mount918, No. 2).

3. Secure the wall mount bracket to the wall with 2 wall mount screws (GV-Mount918, No. 3) and 2 plain washers (GV-Mount918, No. 5).

Note: Thread the network, power and other cables through the wall mount bracket before securing the wall mount bracket to the wall.

4. Unscrew the camera's cover using the supplied torx wrench.
5. Align and secure the camera to the wall mount bracket with 2 M3 screws (GV-Mount918, No. 4).

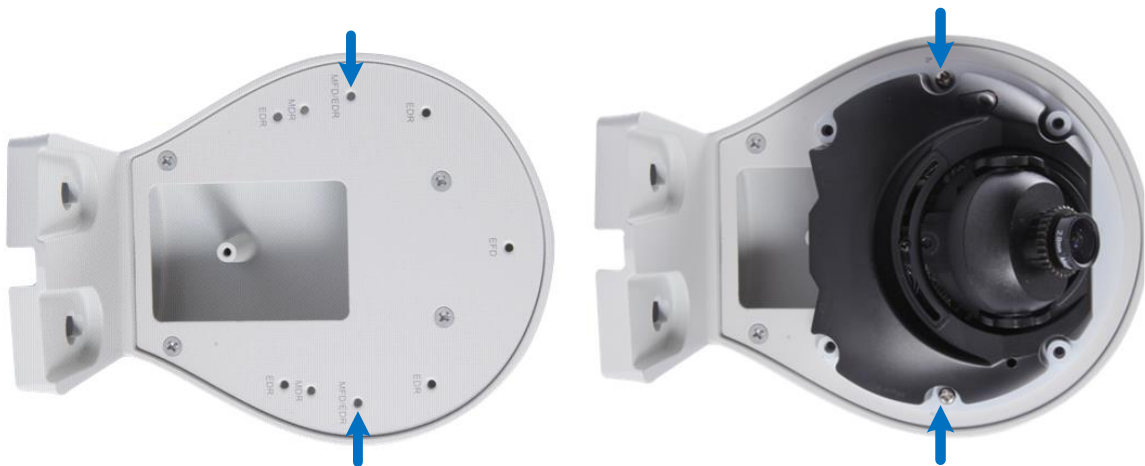

8.2 Power Box Mount



Required accessories:

- GV-Mount910 or GV-Mount913

The user needs to prepare

- Screws for securing the mounting plate to power box

1. Secure the mounting plate (GV-Mount910 or GV-Mount913, No. 1) to the power box with your own screws. Depending on the type of power box, use the holes indicated with the corresponding letter:

GV-Mount910

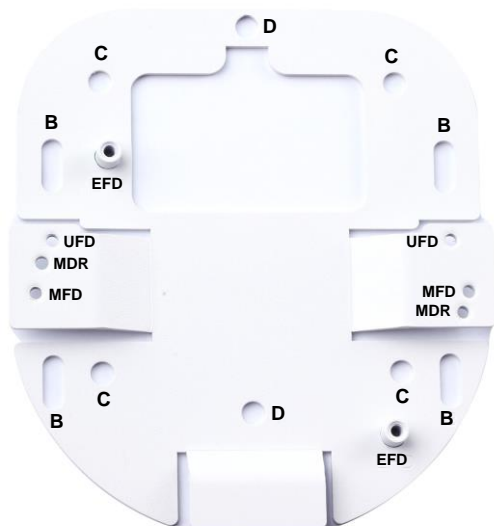

Type of Power Box	Hole
Double Gang	B
4" Octagon	C
Single Gang	D

GV-Mount913

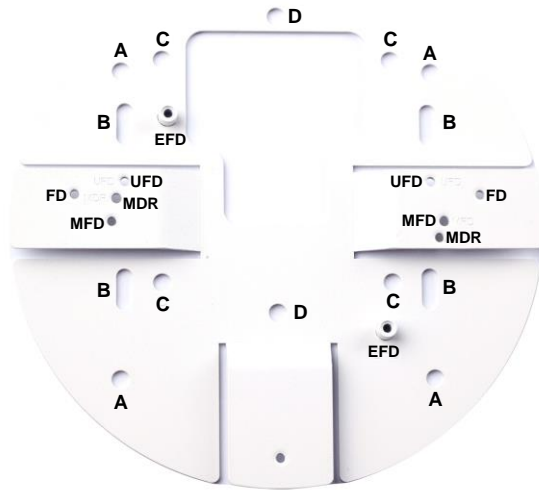

Type of Power Box	Hole
4" Square	A
Double Gang	B
4" Octagon	C
Single Gang	D

2. Remove camera cover with the supplied torx wrench.
3. Secure the camera to the mounting plate with M3 screws (GV-Mount910 or GV-Mount913, No. 2). Use the holes indicated with MFD.



9. Installing the Target Fixed Dome

The instructions in chapter only apply to **GV-EFD4700**.

9.1 Wall Mount Bracket



Required accessories:

- GV-Mount918
-

1. Take the wall mount bracket (GV-Mount918, No. 1) and make 2 marks on the wall for screw anchors.



2. Drill the marks and insert 2 screw anchors (GV-Mount918, No. 2).

- Secure the wall mount bracket to the wall with 2 wall mount screws (GV-Mount918, No. 3) and 2 plain washers (GV-Mount918, No. 5).

Note: Thread the network, power and other cables through the wall mount bracket before securing the wall mount bracket to the wall.

- Open the camera's cover by turning.
- Align and secure the camera to the wall mount bracket with 2 M3 screws (GV-Mount918, No. 4).



9.2 Power Box Mount



Required accessories:

- GV-Mount910 or GV-Mount913

The user needs to prepare

- Screws for securing the mounting plate to power box
-

1. Secure the mounting plate (GV-Mount910 or GV-Mount913, No. 1) to the power box with your own screws. Depending on the type of power box, use the holes indicated with the corresponding letter:

GV-Mount910

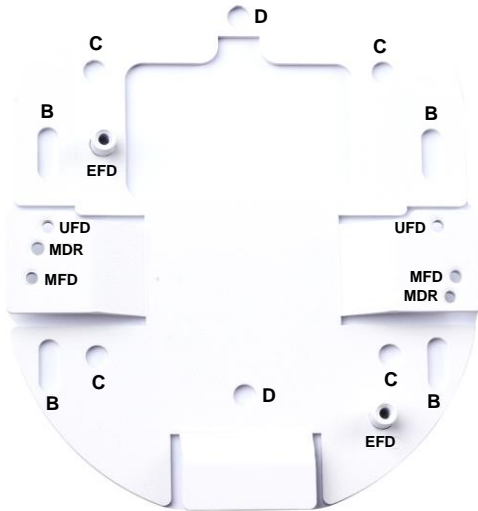

Type of Power Box	Hole
Double Gang	B
4" Octagon	C
Single Gang	D

GV-Mount913

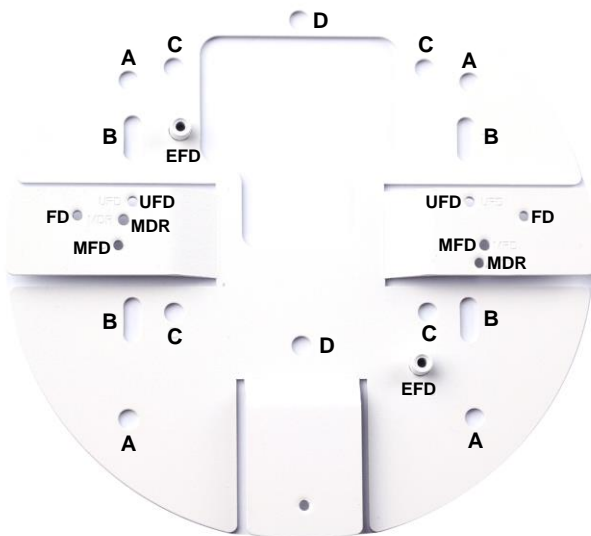

Type of Power Box	Hole
4" Square	A
Double Gang	B
4" Octagon	C
Single Gang	D

9 Installing the Target Fixed Dome

2. Open the camera housing cover.

Use the torx wrench to loosen three screws on housing cover and remove the camera housing. If you are installing **GV-Mount910**, unscrew the three screws to separate the back plate as indicated below.



3. Secure the camera / back plate to the mounting plate with M3 screws (GV-Mount910 or GV-Mount913, No. 2).

Use the holes labeled as **UFD** for GV-Mount910 and **FD** for GV-Mount913. For GV-Mount910, reattach the camera back to the back plate.

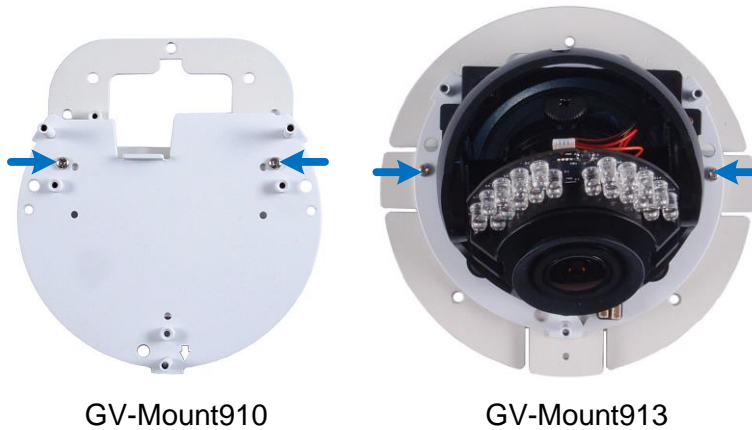

10. Installing the Vandal Proof Dome

10.1 Wall Mount Bracket

The instructions in this chapter only apply to **GV-VD2702 / 2712** of Vandal Proof Dome.

10.1 Wall Mount Bracket



Required accessories:

- GV-Mount206
-

1. Take the wall mount bracket (GV-Mount206, No. 1) and make 4 marks on the wall for screw anchors.



2. Drill the marks and insert 4 screw anchors (GV-Mount206, No. 6).

10 Installing the Vandal Proof Dome

3. Align and secure the mounting plate (GV-Mount206, No. 2) to the wall mount bracket with 4 M4 screws (GV-Mount206, No. 4).

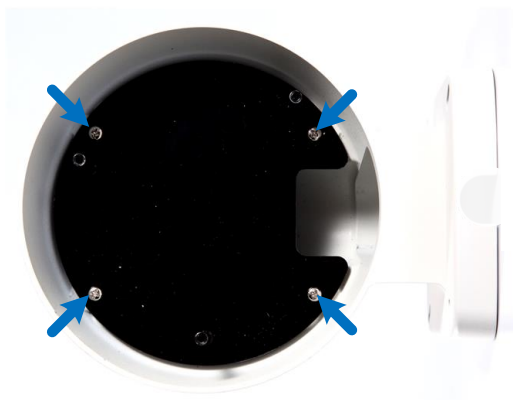

4. Align and secure the housing plate (GV-Mount206, No. 3) to the mounting plate with 3 M4 screws (GV-Mount206, No. 4).



5. Open the camera housing cover, remove the back plate and thread the cables into the camera.
6. Align and secure the camera's back plate to the housing plate with four M4 screws (GV-Mount206, No. 4).



7. Secure the camera to the back plate with the supplied torx wrench.

8. Secure the wall mount bracket to the wall with 40 mm M4 screws (GV-Mount206, No. 5) and plain washers (GV-Mount206, No. 7).

10.2 In-Ceiling Mount



The thickness of the ceiling board must not exceed 4 cm (1.57 in).

Required accessories:

- GV-Mount916

-
1. Assemble the support racks, mounting plate and the mounting ring.
 - A. Secure two brackets (GV-Mount916, No. 1) to the in-ceiling plate (GV-Mount916, No.2) with a black screw (GV-Mount916, No. 5).

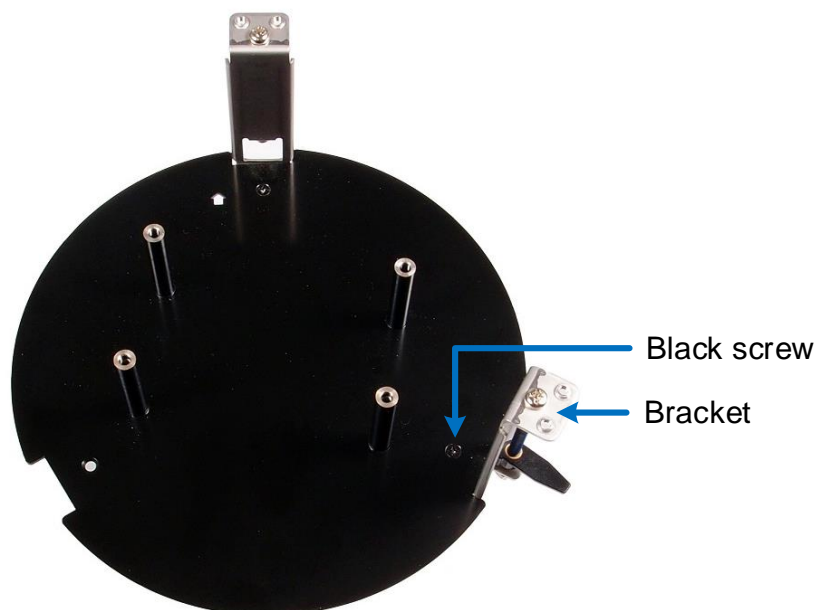

- B. Assemble the in-ceiling ring (GV-Mount916, No. 4). Make sure the arrows on the mounting ring and mounting plate are aligned.

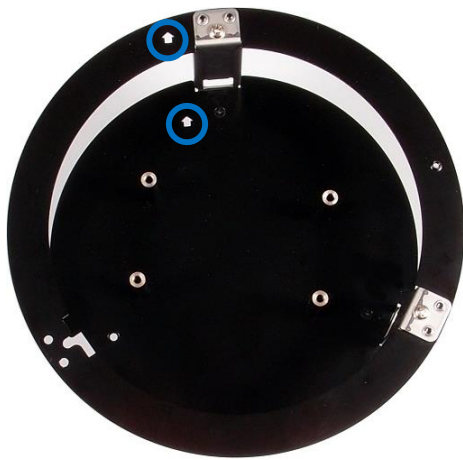

- C. Assemble the third bracket and secure it with a black screw (GV-Mount916, No. 5).
- D. Secure the brackets on the underside of the in-ceiling ring with black screws (GV-Mount916, No. 5).



- E. Use the thread lock (GV-Mount916, No. 9) to attach the in-ceiling cover with the in-ceiling ring using the M3 short screw (GV-Mount916, No. 7).

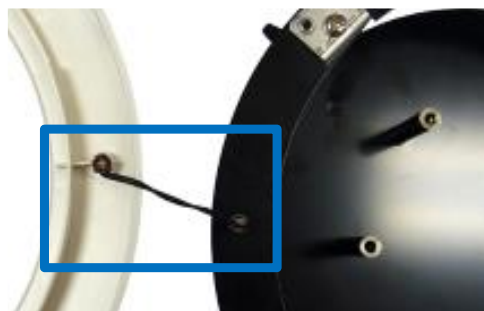

10 Installing the Vandal Proof Dome

2. Open the camera housing cover and remove the back plate.
3. Place the back plate onto the in-ceiling plate, and secure with screws (GV-Mount916, No. 6). The arrow on the in-ceiling ring should be pointing away from the cable opening of the back plate.

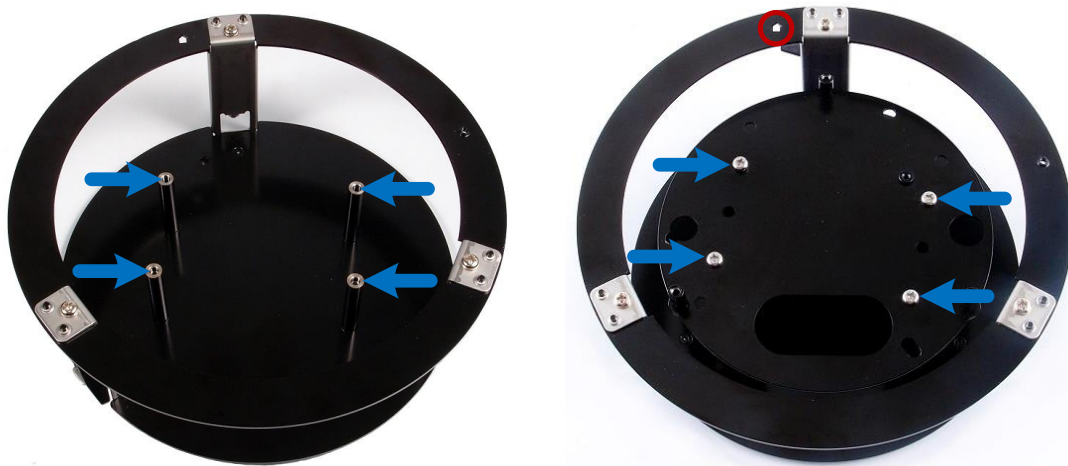

4. Paste the sticker (GV-Mount916, No. 8) to the ceiling, and then cut off the circle part of the ceiling.

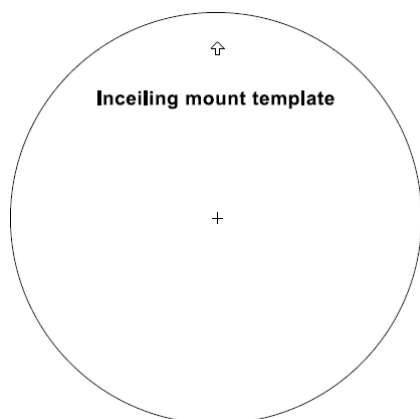

5. Place the mounting casing inside the ceiling hole, and secure the casing with the ceiling.
 - A. Turn the plastic clip of the bracket outward.

B. Tighten the bracket so that the plastic clips are tightly pinching the ceiling board.

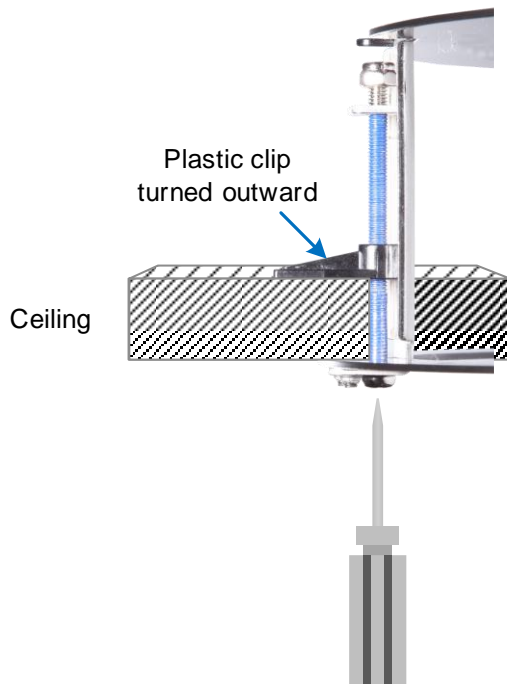

6. Thread the cables through the in-ceiling mount and into the camera.
7. Secure the camera to the back plate with the supplied torx wrench.
8. Place the in-ceiling cover onto the in-ceiling ring. The brackets should align with the three indentations of the in-ceiling cover.



10.3 Assembling Dome Housing



Required accessories:

- GV-Mount903-1
-

1. Open the camera housing cover, remove the back plate and thread the cables into the camera.
2. Secure the back plate to the dome housing with M4 screws (GV-Mount903-1, No. 3). The oval-shaped cable opening on the back plate should be on the opposite side of the arrow inside the dome housing.

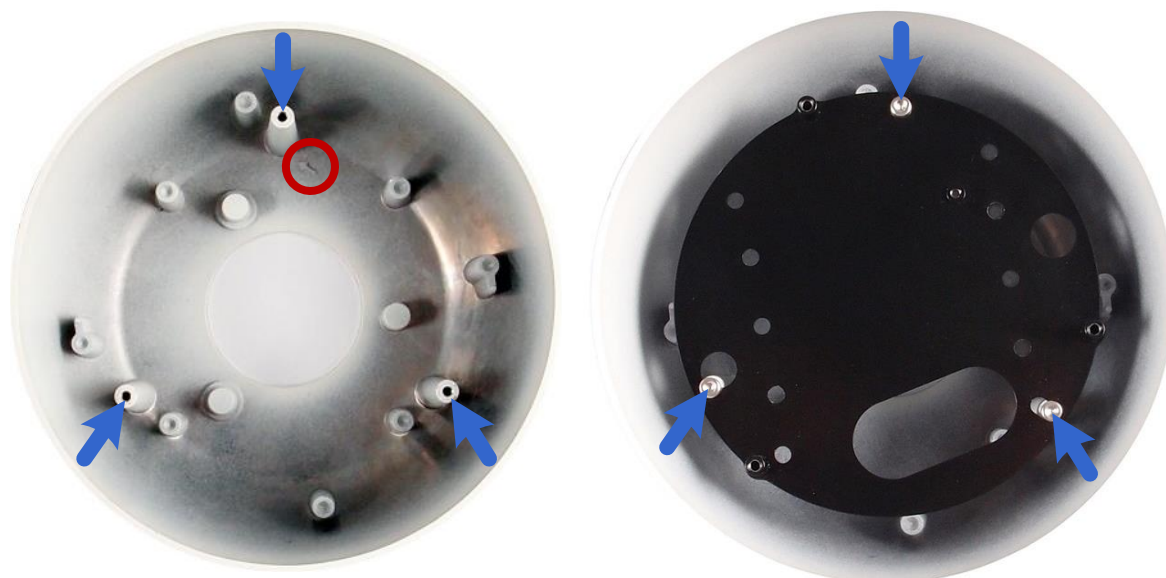

3. Reattach the safety lock and secure the camera to the back plate.

10.4 Wall Pendant Mount



Required accessories:

- GV-Mount200
- GV-Mount903-1

The user needs to prepare:

- Screws for wall x 4
-

1. Assemble the camera with the dome housing. See *10.3 Assembling Dome Housing*.

10 Installing the Vandal Proof Dome

2. Thread the camera cables from the wall through the pendant tube (GV-Mount200, No. 1), and secure the pendant tube to the end of the housing cap (GV-Mount903-1, No. 2) with M6 screws (GV-Mount903-1, No. 4).



3. Secure the wall pendant tube to the wall with 4 self-prepared screws.

10.5 Straight Tube Mount

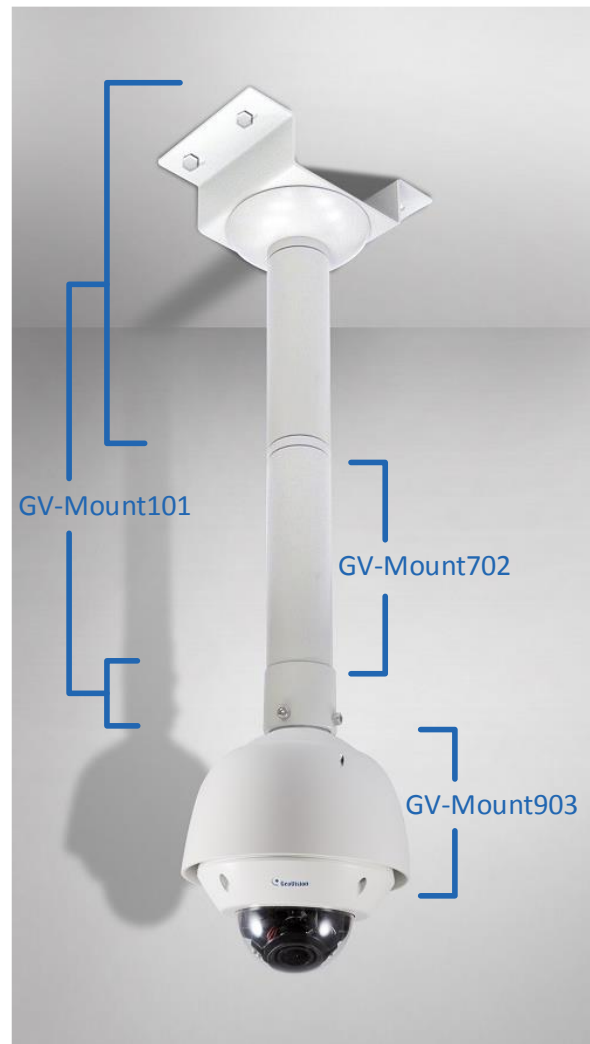

Required accessories:

- GV-Mount101
- GV-Mount903-1

The user needs to prepare:

- Screws for ceiling x 4

Optionally extend with:

- GV-Mount702
-

10 Installing the Vandal Proof Dome

1. Assemble the camera with the dome housing. See *10.3 Assembling Dome Housing*.
2. Assemble the mounting bracket (GV-Mount101, No. 1), the tube (GV-Mount101, No. 2) and the tube connector (GV-Mount101, No. 3). Tighten with the supplied torx wrench (GV-Mount101, No. 4)



3. Secure the tube to the end of the housing cap (GV-Mount902, No. 2) with M6 screws (GV-Mount101, No. 4).



4. Secure the housing bracket to the ceiling with 4 self-prepared screws.

10.6 Straight Tube Box Mount

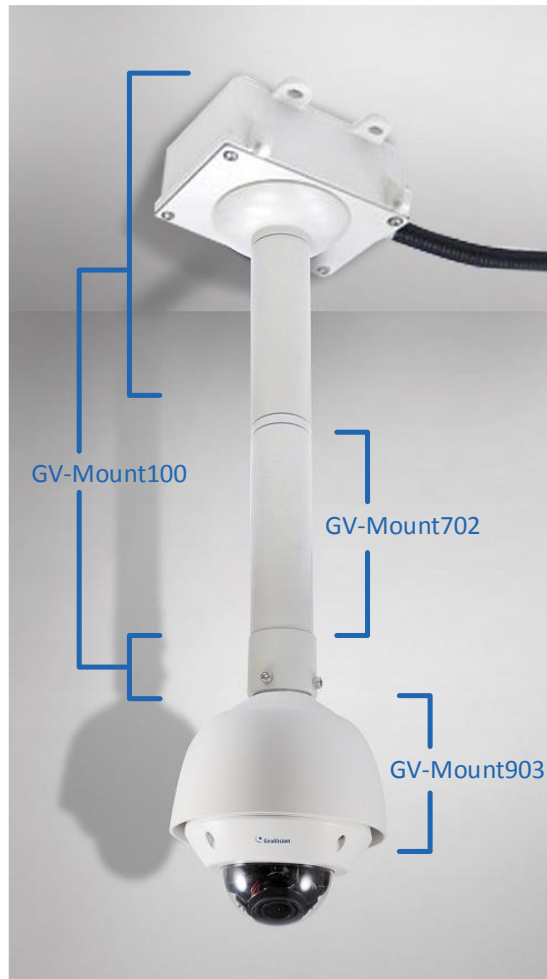

Required accessories:

- GV-Mount100
- GV-Mount903-1

The user needs to prepare:

- Screws for ceiling x 4
- Corrugated tube x 1 (3/4", \varnothing 26.0 ~ 26.5 mm)



Optionally extend with:

- GV-Mount702
-

10 Installing the Vandal Proof Dome

1. Assemble the camera with the dome housing. See *10.3 Assembling Dome Housing*.
2. Follow steps 2 to 6 in *2.2 Straight Tube Box Mount* to install the junction box, corrugated tube and mounting tube.
3. Thread the wires and cables through the housing cap (GV-Mount903-1, No. 2) and secure the tube to the end of the housing cap with M6 screws (GV-Mount903-1, No. 4).

10.7 Convex Corner Mount with Pendant Tube



Required accessories:

- GV-Mount200
- GV-Mount300-1
- GV-Mount903-1

The user needs to prepare:

- Screws for wall x 8
-

1. Assemble the camera with the dome housing. See *10.3 Assembling Dome Housing*.
2. Assemble the mounting plates (GV-Mount300-1, No. 1), slide in the plain washer (GV-Mount300-1, No. 4), then the split washer (GV-Mount300-1, No. 5), and secure them with the screw cap (GV-Mount300-1, No. 6).

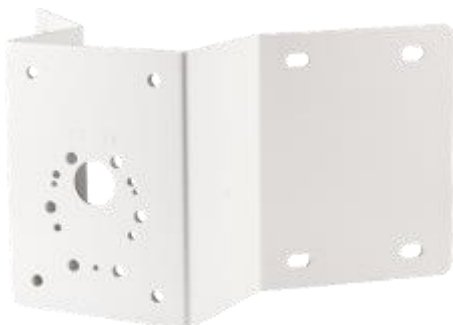

10 Installing the Vandal Proof Dome

3. Secure the pendant tube (GV-Mount200, No. 1) to the plate. Slide the 30 mm M8 screws (GV-Mount300-1, No. 2) from the front and secure from the backside using plain washers (GV-Mount300-1, No. 4), split washers (GV-Mount300-1, No. 5) and the M8 screw caps (GV-Mount300-1, No. 6).



4. Thread the necessary wires and cables through the pendant tube and secure the plate to the wall with 8 self-prepared screws.
5. Thread the wires and cables into the dome and secure the pendant tube to the end of the housing cap (GV-Mount903-1, No. 2) with M6 screws (GV-Mount903-1, No. 4).

10.8 Convex Corner Box Mount

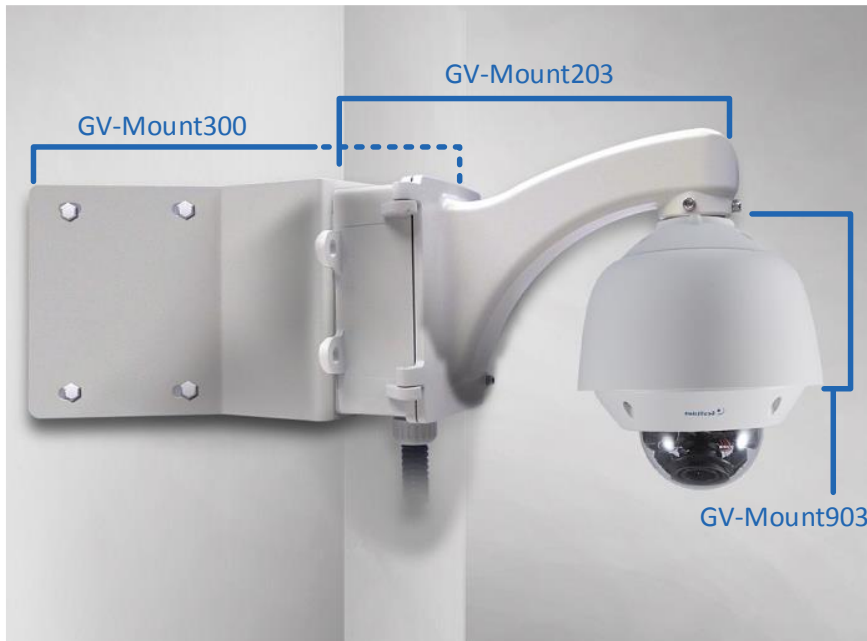

Required accessories:

- GV-Mount203
- GV-Mount300-1
- GV-Mount903-1

The user needs to prepare:

- Screws for wall x 8
- Corrugated tube x 1 (3/4", \varnothing 26.0 ~ 26.5 mm)



-
1. Assemble the camera with the dome housing. See *10.3 Assembling Dome Housing*.
 2. Follow steps 2 to 6 in *2.8 Convex Corner Box Mount* to install the mounting plates, junction box, corrugated tube and pendant tube.
 3. Thread the wires and cables through the pendant tube into the dome housing.

10 Installing the Vandal Proof Dome

4. Secure the pendant tube to the end of the housing cap (GV-Mount903-1, No. 2) with M6 screws (GV-Mount903-1, No. 4).



5. Conceal the junction box with M5 screws using the torx wrench (GV-Mount203, No. 5).

10.9 Concave Corner Mount with Pendant Tube



Required accessories:

- GV-Mount200
- GV-Mount310-1
- GV-Mount903-1

The user needs to prepare:

- Screws for wall x 8
-

1. Assemble the camera with the dome housing. See *10.3 Assembling Dome Housing*.
2. Follow steps 2 and 3 in *2.9 Concave Corner Mount* to assemble the mounting plates and the pendant tube.
3. Thread the necessary wires and cables through the pendant tube and secure the plate to the wall with 8 self-prepared screws.
4. Secure the pendant tube to the end of the housing cap (GV-Mount903-1, No. 2) with M6 screws (GV-Mount903-1, No. 4).

10.10 Pole Mount



Required accessories:

- GV-Mount200
 - GV-Mount400-1 / 410-1
 - GV-Mount903-1
-

1. Assemble the camera with the dome housing. See *10.3 Assembling Dome Housing*.
2. Secure the pendant tube (GV-Mount200, No. 1) to the mounting bracket (GV-Mount400-1 / 410-1, No. 1). Slide the 30 mm M8 screws (GV-Mount400-1 / 410-1, No. 3) from the front and secure from the backside using plain washer (GV-Mount400-1 / 410-1, No. 5), split washer (GV-Mount400-1 / 410-1, No. 6) and screw cap (GV-Mount400-1 / 410-1, No. 7).



Backside View

3. Thread the necessary wires and cables through the pendant tube and secure the mounting bracket to the pole using 3 steel straps (GV-Mount400-1 / 410-1, No. 2). Rotate the screw on the strap to adjust its size.



4. Thread the wires and cables into the dome housing.
5. Secure the pendant tube to the end of the housing cap (GV-Mount903-1, No. 2) with M6 screws (GV-Mount903-1, No. 4).

10.11 Pole Box Mount

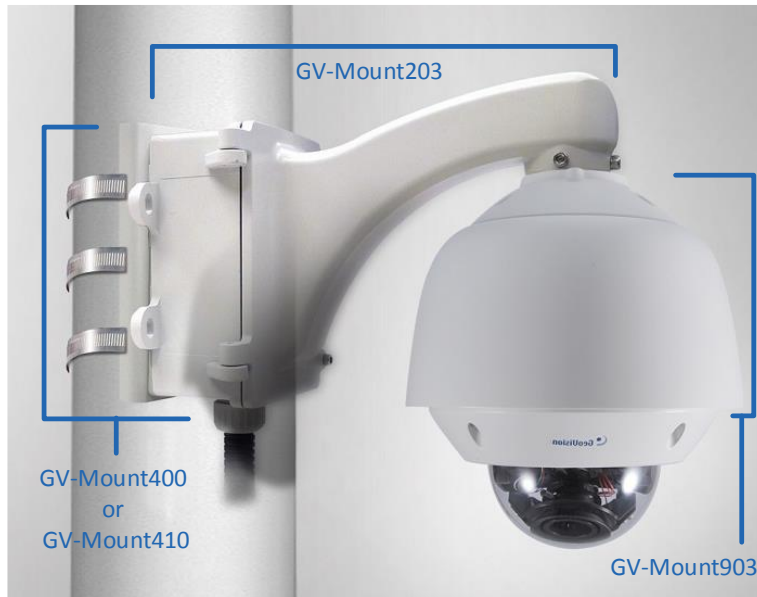

Required accessories:

- GV-Mount203
- GV-Mount400-1 / 410-1
- GV-Mount903-1

The user needs to prepare:

- Corrugated tube x 1 (3/4", ø 26.0 ~ 26.5 mm)



1. Assemble the camera with the dome housing. See *10.3 Assembling Dome Housing*.
2. Follow steps 2 to 5 in *2.12 Pole Box Mount* to install the junction box, mounting bracket, corrugated tube and pendant tube.
3. Thread the wires and cables through the pendant tube into the dome housing.
4. Secure the pendant tube to the end of the housing cap (GV-Mount903-1, No. 2) with M6 screws (GV-Mount903-1, No. 4).
5. Conceal the junction box with M5 screws (GV-Mount203, No. 3) using the torx wrench (GV-Mount203, No. 5).