

GV-TMEB5800 AI 5MP H.265 Super Low Lux WDR Pro Thermal & Optical

IR Fixed Eyeball Dome IP Camera



[Thermal]

- Vanadium oxide uncooled focal plane detector, 12 um pixel size
- Thermal sensitivity: ≤ 50 mK (@25°C, F#=1.0)
- Spectral range: 8 ~ 14 um
- Up to 17 fps at 256 x 192 (output resolution 1280 x 720)
- AI analytics (Fire Detection, Temperature Exception Alarm, Line Crossing, Region Intrusion)
- Sound and light warning

[Optical]

- AI deep learning: AI Perimeter Protection & Classification (Human, Vehicle)
- 1/2.7" progressive scan CMOS sensor
- Min. illumination at 0.02 lux
- Triple streams from H.265, H.264 and MJPEG
- Up to 30 fps at 2592 x 1994
- Intelligent IR
- IR distance up to 30 m (100 ft)
- Day and night function (with removable IR-cut filter)
- Ingress protection (IP66)
- DC 12V / PoE (IEEE 802.3af)
- Built-in micro SD card slot (SD / SDHC / SDXC / UHS-I) for local storage
- Built-in microphone and speaker
- Two-way audio
- 3-axis mechanism (pan / tilt / rotate)
- Wide Dynamic Range Pro (WDR Pro)
- Defog
- 3D noise reduction
- AI analytics (Line Crossing, Region Entrance, Region Exiting, Target Counting, Region Intrusion, Face Detection)
- Active Deterrence: sound and light warning on AI detection events
- Motion detection
- Privacy mask
- 12 languages supported
- ONVIF (Profile G, S, T) conformant

GV-TMEB5800 is an AI-enabled thermal camera that combines dual thermal and optical images for perimeter protection and fire prevention. The thermal camera can detect fires and measure predefined temperatures, triggering lighting and alarms. Even in low-light and harsh environments, the thermal camera with AI analytics is able to detect intrusion events with minimal false alarms. The camera adheres to the IP66 standard, and can be powered through PoE.

GV-TMEB5800 is also a camera for active deterrence. It can deter intruders and prevent potential crime by utilizing the built-in white LED and alarm sound.

Live View

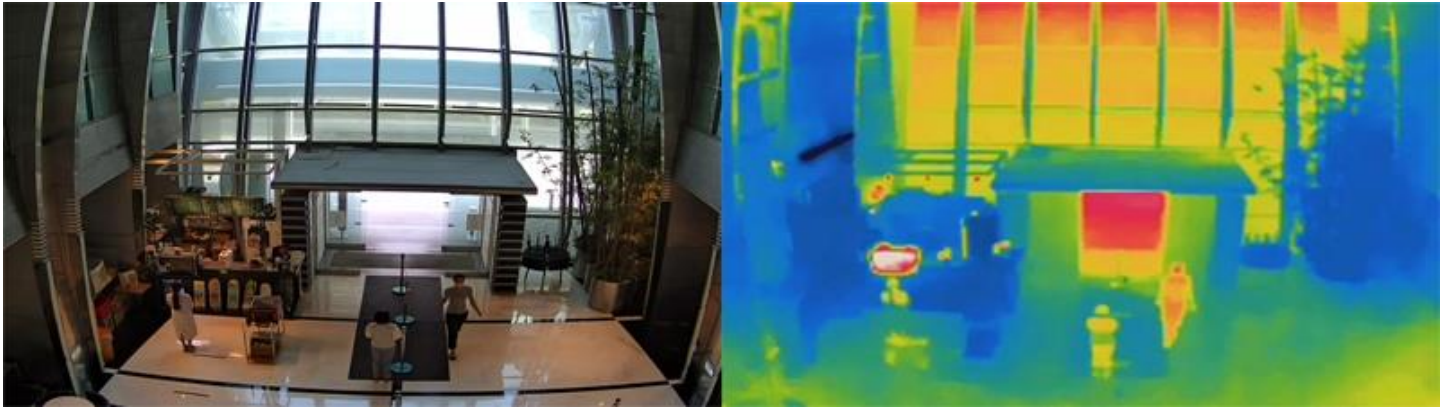

Specifications

Camera – Thermal		
Image Sensor	Vanadium oxide uncooled focal plane detector	
Picture Elements	256 (H) x 192 (V) (the resolution of output image is 1280 x 720)	
Pixel Size	12 μ m	
Thermal Sensitivity	≤ 50 mK (@25°C, F#=1.0)	
Spectral Range	8 ~ 14 μ m	
Gain Control	Auto, Manual	
Focal Length	3.2 mm	
Maximum Aperture	F/1.1	
Horizontal FOV	56°	
Min. Focusing Distance	0.5 m (1.5 ft)	
Color Palettes	Black hot, White hot, Iron Oxide Red, Rainbow, Lava	
Camera - Optical		
Image Sensor	1/2.7" progressive scan CMOS	
Picture Elements	2592 (H) x 1944 (V)	
Minimum Illumination	Color	0.02 Lux (F1.6, AGC ON)
	IR On	0 Lux
Shutter Speed	Auto / Manual (1/3 ~ 1/100000 sec)	
White Balance	Auto / Manual	
Gain control	Auto / Manual	
S/N Ratio	50 dB	
WDR	WDR Pro	
Dynamic Range	Up to 120 dB	
Megapixel	5MP	
Day / Night	Yes (with removable IR-cut filter)	
Lens Type	Fixed	
Focal Length	4 mm	
Maximum Aperture	F/1.6	
Mount	M12	

Horizontal FOV		81°				
Operation	Focus	Fixed				
	Zoom					
	Iris					
IR LED Quantity		2 IR LEDs				
Max. IR Distance		30 m (100 ft)				
DORI		Detect	Observe	Recognize	Identify	
Lens	Thermal (Human: 0.75 m in width)	3.2 mm	133 m (436.3 ft)	N/A	33 m (108.2 ft)	17 m (55.7 ft)
	Thermal (Vehicle: 2.3 m in width)	3.2 mm	409 m (1341.8 ft)	N/A	102 m (334.6 ft)	51 m (167.3 ft)
	Optical	4 mm	70.1 m (229.9 ft)	28.0 m (91.8 ft)	14.0 m (45.9 ft)	7.0 m (22.9 ft)
Operation						
Video Compression		H.265, H.264, MJPEG				
Video Stream		Triple streams				
Frame Rate	Thermal	17 fps at 1280 x 720, 17 fps at 704 x 480, 17 fps at 352 x 240, 17 fps at 480 x 240 (60 / 50 Hz)				
	Optical	30 fps at 2592 x 1944, 30 fps at 2592 x 1520, 30 fps at 2560 x 1440, 30 fps at 2304 x 1296, 30 fps at 1920 x 1080, 30 fps at 1280 x 720, 30 fps at 704 x 480, 30 fps at 352 x 240, 30 fps at 480 x 240 (60 / 50 Hz) * The frame rate and performance may vary depending on the number of connections and data bitrates (different scenes).				
Video Analytics		Motion Detection, Video Exception Detection (Scene Change, Video Blur, Video Cast Detection)				
Smart Alarm		Motion Detection, SD Card Error, SD Card Full, IP Address Conflict, Cable Disconnection				
Image Setting		Brightness, Contrast, Saturation, Sharpness, Flicker-less, 3D Noise Reduction, Image Orientation (Flip, Mirror, 0°, 180°)				
White LED Light & Alarm Sound		Flashing light and alarm sound				
Noise Reduction		Yes				
Audio Compression		G.711				
Audio Support		Two-way Audio				
Digital I/O	Input	1 Input, dry contact, NO / NC				
	Output	1 Relay Output (1A 30V DC / 0.3A 125V AC)				
Video Resolution						
Thermal		1280 x 720 (Default), 704 x 480, 352 x 240, 480 x 240				
Main Stream		2592 x 1944 (Default), 2592 x 1520, 2560 x 1440, 2304 x 1296, 1920 x 1080, 1280 x 720				
Sub Stream		1280 720, 704 x 480 (Default), 352 x 240				
Third Stream		704 x 480 (Default), 352 x 240, 480 x 240				
Network						
Interface		10/100 Ethernet				

Protocol	UDP, IPv4, IPv6, DHCP, NTP, RTSP, RTP, RTCP, PPPoE, DDNS, SMTP, FTP, SNMP, HTTP, 802.1x, UPnP, HTTPS, QoS, ONVIF	
Deep Learning Function		
AI Perimeter Protection	Thermal	-Fire Detection, Temperature Exception Alarm -Line Crossing, Region Intrusion: with Human & Vehicle classification
	Optical	-Line Crossing, Region Entrance, Region Exiting, Target Counting, Region Intrusion: with Human & Vehicle classification -Face Detection
Fire Detection	Object (0.1 x 0.1 m)	11 m (36.1 ft)*
Temperature Measurement	Object (1 x 1 m)	30 m (98.4 ft)*
Video Content Analysis Range (Thermal)	Human (0.75 m)	24 m (78.7 ft)*
	Car (2.3 m)	35 m (114.8 ft)*
Video Content Analysis Range (Optical)	Human	10 m (32.8 ft)*
	Car	20 m (65.6 ft)*
Temperature Alarm Range	-20°C ~ 150 °C (-4 °F ~ 302 °F)	
Temperature Alarm Accuracy	±8°C (±14.4°F)	
* The data is only for reference and the performance may vary according to the actual environment.		
Mechanical		
Camera Angle Adjustment	Pan	0° ~ 360°
	Tilt	0° ~ 75°
	Rotate	0° ~ 360°
Connectors	Power	DC Jack, PoE
	Ethernet	RJ-45 cable
	Audio	1 In (Audio In Wire) 1 In (built-in microphone) 1 Out (built-in speaker)
	Digital I/O	4-pin terminal block pitch 3.81 mm (0.15")
	Local Storage	Micro SD card slot (SD / SDHC / SDXC / UHS-I, Class 10) * UHS-II card type is not supported.
General		
Environment Temperature	-30°C ~ 60 °C (-22 °F ~ 140 °F)	
Humidity	0 ~ 95% (no condensation)	
Power Source	12V DC / PoE (IEEE 802.3af)	
Max. Power Consumption	9 W	
Dimensions	Ø111.5 × 99.6 mm (Ø4.39" x 3.92")	
Weight	0.68 kg (1.5 lb)	
Ingress Protection	IP66	
Certification	CE, FCC, RoHS compliant	
Web Interface		
Installation Management	Web-based configuration	
Maintenance	Firmware upgrade through Web Browser or GV-IP Device Utility (V8.9.8 or later)	
Access from Web Browser	Live View, Playback, Video Recording, Image Quality, Bandwidth Control, Image Snapshot, Two-way Audio, Digital Zoom, Text Overlay, Image Masking	

Language	Czech, English, French, German, Hungarian, Italian, Japanese, Polish, Portuguese, Russian, Spanish, Traditional Chinese
Software Applications	
Software Supported	GV-VMS (V17.4.5 / V18.3.1, patch files required), GV-Recording Server (V2.1.0 or later), GV-Control Center (V4.1.1 or later)
Live Viewing	Browser (IE, Edge, Chrome, Firefox, Safari) *It is required to use IE or Edge IE mode to access thermal images.

Note:

1. The integration with GV-SNVR series is not supported.
2. Specifications are subject to change without notice.

Packing List

- | | |
|----------------------|--------------------------|
| 1. Eyeball Dome | 4. Hex Key |
| 2. Waterproof Rubber | 5. Drill Template Paster |
| 3. Screw Kit | 6. Download Guide |

Dimensions

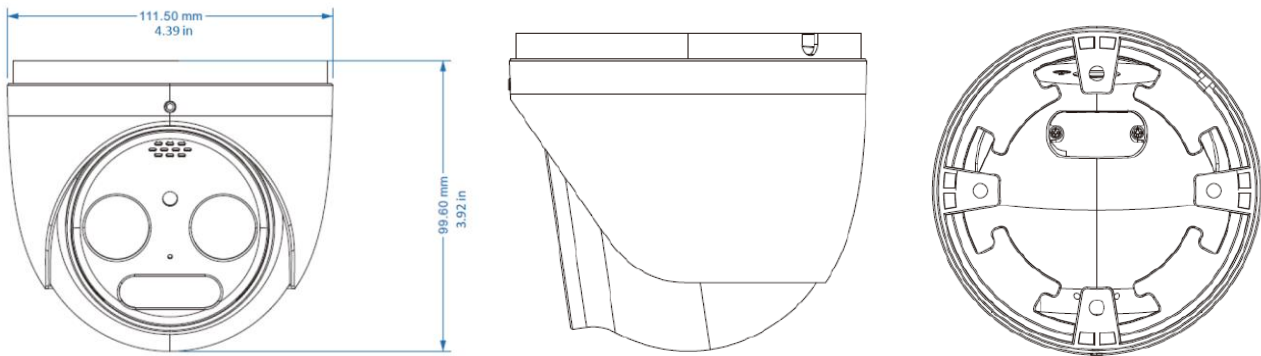

Deep Learning Function

Face Detection

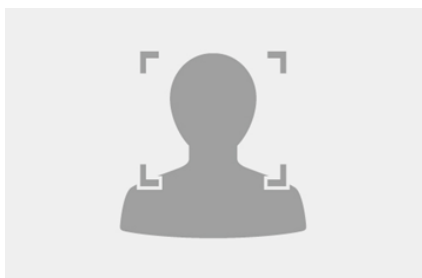

AI Perimeter Protection

(Intrusion, Cross Line Enter Area, Leave Area)



People Counting

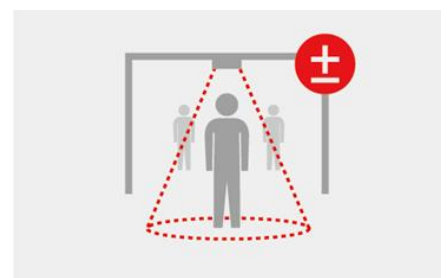





Fire Detection



Temperature Exception Alarm



Accessories

Model No.	Name		Details
GV-Mount506	Junction Box		Dimensions: 139.3 x 171.6 x 50 mm (5.48" x 2.81" x 1.97") Weight: 0.512 kg (1.13 lb)
Mount211-4	Wall Mount Bracket		Dimensions: 129.8 x 154.9 x 74.4 mm (5.11" x 6.1" x 2.93") Weight: 0.527 kg (1.16 lb)
GV-Mount211-6 (must be used with GV-Mount506)	Wall Mount Bracket		Dimensions: 199 x 139.3 x 140.9 mm (7.83" x 5.48" x 5.55") Weight: 0.56 kg (1.23 lb)
GV-PA191	Power over Ethernet (PoE) Adapter		GV-PA191 is a Power over Ethernet (PoE) adapter to provide power to the IP device through a single Ethernet cable.
GV-POE Switch			GV-POE Switch is designed to provide power along with network connection for IP devices. It is available in various models with different numbers and types of ports.
Power Adapter			Contact our sales representatives for the countries and areas supported.