

# **GV-TDR4803 AI 4MP H.265 Super Low Lux WDR Pro IR Mini Fixed Rugged IP**

## **Dome**



- AI deep learning: AI Perimeter Protection & Classification (Human, Vehicle)
- 1/3" progressive scan super low lux CMOS sensor
- Min. illumination at 0.003 lux
- Triple streams from H.265, H.264 or MJPEG
- Wide Dynamic Range Pro (WDR Pro)
- Up to 30 fps at 2688 x 1520
- Intelligent IR
- Day and night function (with removable IR-cut filter)
- IR distance up to 30 m (100 ft)
- Built-in micro SD card slot (SD / SDHC / SDXC / UHS-I, Class 10) for local storage
- 3-axis mechanism (pan / tilt / rotate)
- Ingress protection (IP67)
- Vandal Resistance (IK10)
- Two-way audio capable
- DC 12V / PoE (IEEE 802.3af)
- ONVIF (Profile G, S, T, M) conformant

## **Introduction**

GV-TDR4803 is an outdoor, fixed, network camera equipped with an automatic IR-cut filter and an IR LED for day and night surveillance. The camera supports H.265 video codec to achieve better compression ratio while maintaining high quality pictures at reduced network bandwidths. The camera adheres to IP67 and IK10 standards, and can be powered through PoE.

Empowered by deep learning algorithms, AI technology distinguishes human and vehicles from other moving objects. Integrated with GeoVision Video Management Software (VMS), it supports AI perimeter protection, real time alert, events playback and more.

## **Deep Learning Function**

### **Face Detection**



### **AI Perimeter Protection**

(Intrusion, Crossing Line  
Entering Area, Leaving Area)



### **People Flow Counting**



## Dimensions

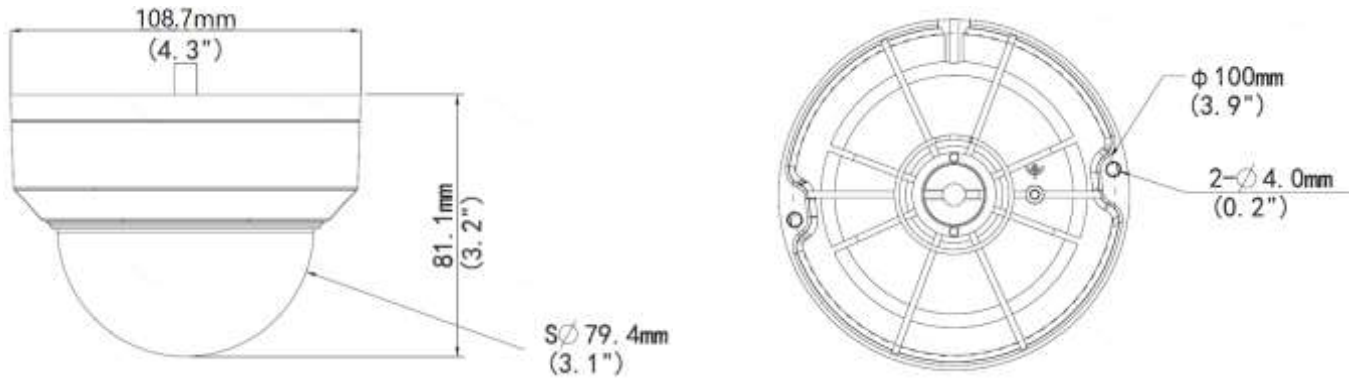

## Specifications

Camera					
Image Sensor		1/3" progressive scan super low lux CMOS			
Picture Elements		2688 (H) x 1520 (V)			
Minimum Illumination	Color	0.003 Lux (F1.6, AGC ON)			
	IR ON	0 Lux			
Shutter Speed		Auto / Manual (1 ~ 1/100000 sec)			
White Balance		Automatic, Manual			
Gain Control		Automatic, Manual			
S/N Ratio		56 dB			
WDR Pro		Yes			
Dynamic Range		120 dB			
Lens					
Megapixel		4M			
Day / Night		Yes (with removable IR-cut filter)			
Lens Type		Fixed			
Focal Length		2.8 mm			
Maximum Aperture		F/1.6			
Mount		M12			
Horizontal FOV		101°			
Operation	Focus	Fixed			
	Zoom	Fixed			
	Iris	Fixed			
IR LED Quantity		1 IR LED			
Max. IR Distance		30 m (100 ft)			
DORI		Detect	Observe	Recognize	Identify
Lens	2.8 mm	63 m (206.7 ft)	25.2 m (82.7 ft)	12.6 m (41.3 ft)	6.3 m (20.7 ft)
Operation					
Video Compression		H.265, H.264, MJPEG			
Video Streaming		Triple streams from H.265, H.264 or MJPEG			
Frame Rate		30 fps at 2688 x 1520, 30 fps at 2560 x 1440, 30 fps at 2304 x 1296, 30 fps at 1920 x 1080 (60 / 50 Hz) * The frame rate and performance may vary depending on the number of connections and data bitrates (different scenes).			
Video Analytics		Motion Detection, Tampering Alarm, Audio Detection *Tampering alarm and audio detection are only accessible through the camera's Web interface, which can be used to trigger alerts such as e-mail and FTP			
Image Setting		Brightness, Contrast, Saturation, Sharpness, Flicker-less, Image Orientation (Flip, Mirror, 90°, 180°)			
Audio Compression		G.711			
Audio Support		Two-way Audio (external microphone and speaker required)			
Digital I/O	Input	1 Input, dry contact, NO / NC			
	Output	1 Relay Output (1A 30V DC / 0.3A 125V AC)			

Face Detection		
Environment		100 lux
Detectable face angle	Tilt (Up/Down)	≤ 10°
	Swing (Left/Right)	≤ 30°
Max. number of faces		Up to 40
Min. face image pixel requirement		80 pixels
Deep Learning Function		
AI Analytics		Intrusion, Crossing Line, Entering Area, Face Detection, Leaving Area (Human & Vehicle classification), People Flow Counting, Crowd Density Monitoring
Network		
Interface		10/100 Base-TX Ethernet
Protocol		802.1x, ARP, DHCP, DDNS, DNS, DynDNS, FTP, HTTP, HTTPS, ICMP, IGMP, IPv4, IPv6, NTP, PPPoE, QoS, RTCP, RTP, RTSP, SMTP, SNMP, TCP, UDP, UPnP, ONVIF (Profile G, S, T, M)
Video Resolution		
Main Stream		2688 x 1520 (Default), 2560 x 1440, 2304 x 1296, 1920 x 1080, 1280 x 720
Sub Stream		1280 x 720, 720 x 576, 640 x 360 (Default), 640 x 480
Third Stream (Closed by Default)		720 x 576, 704 x 288, 640 x 360, 352 x 288
Mechanical		
Temperature Detector		No
Camera Angle Adjustment	Pan	3° ~ 360°
	Tilt	0° ~ 68°
	Rotate	3° ~ 360°
Connectors	Power	DC Jack (DC 12 V, 1.25 A), PoE
	Ethernet	RJ-45 connector
	Audio	1 in (Audio In Wire); 1 out (Audio Out Wire) *The Audio In port only support microphones with power supply.
	Digital I/O	I/O wires
	Local Storage	Micro SD card slot (SD / SDHC / SDXC / UHS-I, Class 10) *UHS-II card type is not supported.
General		
Operating Temperature		-30°C ~ 60°C (-22°F ~ 140°F)
Humidity		0% ~ 95% (no condensation)
Power Source		12 V DC / PoE (IEEE802.3af)
Max. Power Consumption		4.5 W
Dimensions		∅ 108.7 x 81.1 mm (∅4.3" x 3.2")
Weight		0.42 kg (0.93 lb)
Ingress Protection		IP67
Vandal Resistant		IK10
Certification		FCC, CE, RoHS, UL compliant
Web Interface		
Installation Management		Web-based configuration
Maintenance		Firmware upgrade through Web Browser or GV-IP Device Utility (V8.7.2.1)
Access from Web Browser		Live View, Video Recording, Change Video Quality, Bandwidth Control, Image Snapshot, Defog, Text Overlay, Image Masking
Language		Czech, English, French, German, Hungarian, Italian, Japanese, Polish, Portuguese, Russian, Spanish, Traditional Chinese
Applications		
Software Supported		GV-VMS (V17.4.2 / V18.2.1), GV-DVR / NVR (V8.9.1), GV-Control Center (V3.8.0), GV-Recording Server / Video Gateway (V2.0.0), GV-Edge Recording Manager Win version (V2.0.0), GV-Redundant / Failover Server (V1.2.0), GV-Mobile Server (V1.5.1)
Smart Device Access		GV-Eye for iOS and Android
Live Viewing		Browser (IE, Edge, Chrome, Firefox, Safari), Mobile App









**Note:**

1. Patch files are required for some supported software.
2. Do not use clothes or any ordinary material to clean the camera cover since they may result in scratches.
3. Specifications are subject to change without notice.

**Packing List**

- |                          |                          |
|--------------------------|--------------------------|
| 1. GV-TDR4803 Mini Dome  | 4. Drill Template Paster |
| 2. Waterproof Rubber Set | 5. Torx Wrench           |
| 3. Screw Kit             | 6. Download Guide        |

**Accessories**

Model No.	Name		Details
GV-Mount107 (must be used with GV-Mount213)	Pendant Bracket		Dimensions: Ø 120 x 334 mm (Ø 4.72" x 13.15") Weight: 0.74 kg (1.63 lb)
GV-Mount211P	Wall Mount and Junction Box		Dimensions: Ø 233 x 125 x 125 mm (Ø 9.2" x 4.9" x 4.9") Weight: 1 kg (2.2 lb)
GV-Mount213	Wall / Ceiling Box Mount		Dimensions: Ø 109 x 39 mm (Ø 4.3" x 1.5") Weight: 0.2 kg (0.44 lb)
GV-Mount300-2	Convex Corner Mount		Dimensions: 137 x 233 x 160 mm (5.4" x 9.17" x 6.3") Weight: 1.65 kg (3.64 lb)
GV-Mount310-2	Concave Corner Mount		Dimensions: 111.2 x 369.9 x 210 mm (2.6" x 11.4" x 6.6") Weight: 1.65 kg (3.64 lb)
GV-Mount420 (must be used with GV-Mount211P)	Pole Mount Bracket		Dimensions: Ø 120 x 120 x 53.4 mm (Ø 4.7" x 4.7" x 2.1") Weight: 0.45 kg (0.99 lb) Steel Strap Diameter: Ø 67 ~ 127 mm (Ø 2.6" ~ 5")
GV-Mount704 (must be used with GV-Mount107)	Extension Tube		Dimensions: Ø 3.5 x 10 or 20 or 30 or 50 cm (Ø 1.38" x 3.9" or 7.9" or 11.8" or 19.7") Weight: 225 g or 360 g or 500 g or 780 g (0.5 lb or 0.79 lb or 1.1 lb or 1.72 lb)
GV-Mount924 (for standard US single and double gang boxes only)	Power Box Mount Bracket		Dimensions: Ø 128 x 18.5 mm (Ø 5" x 0.7") Weight: 0.15 kg (0.33 lb)
GV-PA191	Power over Ethernet (PoE) Adapter		The GV-PA191 is a Power over Ethernet (PoE) adapter designed to provide power to the IP device through a single Ethernet cable.
GV-POE Switch			The GV-POE Switch is designed to provide power along with network connection for IP devices. The GV-POE Switch is available in various models with different numbers and types of ports.
Power Adapter			Contact our sales representatives for the countries and areas supported.