

GV-IPSH30 V2.0 Installation Guide

PoE Network Horn Speaker



Contents

Welcome	1
Warning.....	1
Installation environment	2
Important safety instructions	2
Features	3
Schematic diagram	3
Mounting instruction	4

Welcome

A personal welcome to you from the management and employees of our global.

Thanks you for choosing our high quality product, we will always provide innovative, advanced, reliable products like before.

We are sincerely trust these products will provide years of satisfactory service, but if anything is not to your complete satisfaction, we will endeavor to make things right.

Welcome again, and thank you for becoming part of our worldwide extended family!

Warning



CAUTION
RISK OF ELECTRIC SHOCK DON'T OPEN



CAUTION: TO REDUCE THE RISK OF ELECTRIC SHOCK,
DO NOT REMOVE COVER (OR BACK).
NO USER-SERVICEABLE PARTS INSIDE.
REFER SERVICING TO QUALIFIED SERVICE PERSONNEL.



This symbol is intended to alert the user to the presence of uninsulated "dangerous voltage" within the product's enclosure that may be of sufficient magnitude to constitute a risk of electric shock to persons.



This symbol is intended to alert the user to the presence of important operation and maintenance (servicing) instructions in the literature accompanying the appliance.

Caution: To prevent electric shock do not use this (polarized) plug with an extension cord, receptacle or other outlet unless the blades can be fully inserted to prevent blade exposure.

Attentions: Pour prévenir les chocs électriques ne pas utiliser cette fiche polarisée avec un prolongateur, une prise de courant on une autre sortie de courant, sauf si les lames peuvent être insérées à fond sans en laisser aucune partie à découvert.

WARNING

* Do not install this equipment in a narrow space environment such as bookshelves, wooden tables and other similar items.

* For the terminals marked with symbol of ⚡ may be of sufficient magnitude to constitute a risk of electric shock. The external wiring connected to the terminals requires installation by an instructed person or the used of ready-made leads or cords.

* The appliance coupler is used as disconnect device, the disconnect device shall remain readily operable.

* Protective earthing terminal. The apparatus should be connected to a mains socket outlet with a protective earthing connection.

* Increase the minimum distance of the prototype to the surrounding environment.

* no naked flame sources, such as lighted candles, should be placed on the apparatus;

* The use of apparatus in tropical climates.

* The use of apparatus in moderate climates.

* Do not install this equipment in a confined space such as a book case or similar unit.

Service Instructions

* Worded: "Caution: These servicing instructions are for use by qualified service personnel only. To reduce the risk of electric shock, do not perform any servicing other than that contained in the operating instructions unless you are qualified to do so."

* Location: Instruction Manual.

NOTE : This equipment has been tested and found to comply with the limits for a Class A digital device, pursuant to Part 15 of the FCC Rules. These limits are designed to provide reasonable protection against harmful interference when the equipment is operated in a commercial environment. This equipment generates, uses, and can radiate radio frequency energy and, if not installed and used in accordance with the instruction manual, may cause harmful interference to radio communications. Operation of this equipment in a residential area is likely to cause harmful interference in which case the user will be required to correct the interference at his own expense.

Installation Environment

Installation this system is not difficult and complex. But you still need to spend some time to read this manual and ensure the connection and installation is exact.

Never place this product in an environment which could alter its performance or reduce its service life.

Such environments usually include high levels of heat, dust, and vibration.

Important Safety Instructions



1. Read these instructions.
2. Keep these instructions.
3. Heed all warnings.
4. Follow all instructions.
5. Clean only with dry cloth.
6. Do not block any ventilation openings. Install in accordance with the manufacturer's instructions.
7. Do not install near any heat sources such as radiators, heat registers, stoves, or other apparatus (including amplifiers) that produce heat.
8. Do not defeat the safety purpose of the polarized or grounding-type plug. A polarized plug has two blades with one wider than the other. A grounding type plug has two blades and a third grounding prong. The wide blade or the third prong are provided for your safety. If the provided plug does not fit into your outlet, consult an electrician for replacement of the obsolete outlet.
9. Protect the power cord from being walked on or pinched particularly at plugs, convenience receptacles, and the point where they exit from the apparatus.
10. Only use attachments/accessories specified by the manufacturer.
11. Use only with the cart, stand, tripod, bracket, or table specified by the manufacturer, or sold with the apparatus. When a cart is used, use caution when moving the cart/apparatus combination to avoid injury from tip-over.
12. Unplug this apparatus during lightning storms or when unused for long periods of time.
13. Refer all servicing to qualified service personnel. Servicing is required when the apparatus has been damaged in any way, such as power-supply cord or plug is damaged, liquid has been spilled or objects have fallen into the apparatus, does not operate normally, or has been dropped.

- Avoid excessive heat, dust and vibration

Keep the unit away from locations where it is likely to be exposed to high temperatures-such as near radiators, stoves, etc. Also avoid locations which are subject to excessive dust accumulation, or to vibration that could cause mechanical damage.

- Avoid physical shocks

Strong physical shocks to the unit may cause damage. Handle the unit with care.

- Do not open the case or attempt repairs or modifications yourself

This product contains no user-serviceable parts. Refer all maintenance to qualified service personnel. Opening the case and/or tampering with internal circuitry voids the warranty.

- Always power off before making connections

Always turn the AC mains OFF before connecting or disconnecting cables. This is important to prevent damage to the unit itself as well as other connected equipment.

- Handle cables carefully

Always plug and unplug cables (including the AC mains power cord) by gripping the connector, not the cord.

- Clear with a soft dry cloth

Never use solvents such as benzene or paint thinner to clean the unit. Wipe clean with a soft, dry cloth.



Features:

- Any place with an Ethernet port can be accessed. It can play network audio and can accept the access and control of servers and other IP network devices.
- Network fault self-diagnosis, with PoE (IEEE 802.3at) power supply network port, compatible with SIP protocol, ONVIF (RTSP) protocol.
- Built-in 30W digital amplifier, low power amplifier heat generation, safe and reliable, suitable for long-term work; simple connection, easy to use.
- The dustproof and waterproof grade conforms to the IEC529 IP66 standard.
- The lightweight, high-strength ABS synthetic resin housing can resist a variety of impacts.
- UV protection and all-weather design can handle years of installation in outdoor environments.
- Strong directivity and efficient broadcasting.
- U-shaped mounting brackets provide quick and easy installation.

Schematic diagram:

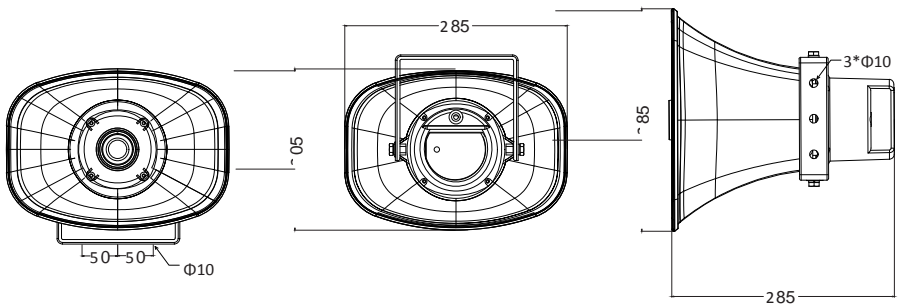

Dimensions (Unit: mm)

Mounting instruction:

1. First, drill 3 holes on the wall suitable for the M10 expansion screw, with a spacing of 50mm between the holes, and drive the M10 expansion screws into the 3 holes separately.

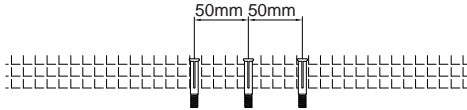

2. Align the hole on the product bracket with the pre-drilled screw rod on the wall, lock the M10 nut and fix the product on the wall.

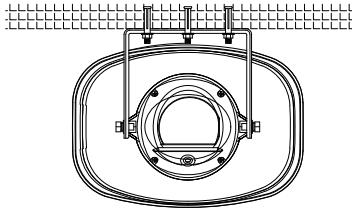

3. Then adjust the desired angle of the speaker, and then connect the power cord and network cable to the speaker.

