



UA-SNVR

User's Manual



- **UA-SNVR3240-N**
- **UA-SNVR1620-P**
- **UA-SNVRL810-P**

Before attempting to connect or operate this product, please read these instructions carefully and save this manual for future use.

UVSSNVR-UM-A



© 2023 USA Vision, Inc. All rights reserved.

Under the copyright laws, this manual may not be copied, in whole or in part, without the written consent of USA Vision.

Every effort has been made to ensure that the information in this manual is accurate. USA Vision makes no expressed or implied warranty of any kind and assumes no responsibility for errors or omissions. No liability is assumed for incidental or consequential damages arising from the use of the information or products contained herein. Features and specifications are subject to change without notice.

USA Vision Systems Inc.

9301 Irvine Blvd,

Irvine, CA 92618, USA

Tel: +1-949-421-5910

Fax: +1-949-583-152

<https://www.geovision.com.tw/us/>

April 2023

Scan the following QR codes for product warranty and technical support policy:



[Warranty]



[Technical Support Policy]

Contents

SAFETY INSTRUCTION	4
Chapter 1 Product Overview	1
1.1 Front View	1
1.2 Rear View	2
1.2.1 UA-SNVR3240-N.....	2
1.2.2 UA-SNVR1620-P.....	3
1.2.3 UA-SNVRL810-P.....	4
Chapter 2 NVR Installation & Connection	5
2.1 HDD Installation	5
2.2 Connection Diagram	6
2.3 Power Supply Connection	6
Chapter 3 NVR Common Operations	7
3.1 Using the Supplied Mouse	7
3.2 Using the Virtual Keyboard	7
3.3 Password	8
Chapter 4 NVR Starting up	9
4.1 Start Wizard	9
4.1.1 Start Wizard.....	9
4.1.2 Network Configuration	10
4.1.3 Date/Time	12
4.1.4 IP Camera.....	14
4.1.5 Disk.....	16
4.1.6 Resolution.....	16
4.1.7 Mobile.....	17
4.1.8 Summary.....	17
4.2 Live View Screen Overview	18
4.2.1 Camera Quick Toolbar	19
4.2.2 Taskbar.....	20
4.2.3 Start Menu	21
4.2.4 Fisheye Camera.....	22
Chapter 5 NVR System Setup	25
5.1 Channel	25
5.1.2 Live	28
5.1.3 Image Control.....	30
5.1.4 PTZ.....	32
5.1.5 Motion.....	34
5.1.6 Video Cover.....	35
5.1.7 Intelligent.....	36

5.2 Record	41
5.2.1 Encode	41
5.2.2 Record	42
5.2.3 Capture	44
5.3 Alarm	46
5.3.1 Motion	46
5.3.2 I/O	47
5.3.3 Intelligent	48
5.3.4 Combination Alarm	49
5.3.5 PTZ Linkage	51
5.3.6 Exception	51
5.3.7 Voice Prompts	53
5.4 AI	57
5.4.1 Setup	58
5.4.2 Face Recognition	77
5.4.3 Alarm	81
5.4.4 Statistics	85
5.5 Network	89
5.5.1 General	89
5.5.2 DDNS	92
5.5.3 Email	93
5.5.4 IP Filter	96
5.5.5 Voice Assistant	97
5.5.6 Platform Access	98
5.6 Storage	101
5.6.1 Disk	101
5.6.2 Cloud	105
5.6.3 FTP	108
5.7 System	109
5.7.1 General	109
5.7.2 Output Configuration	113
5.7.3 Multi-user	116
5.7.4 Maintenance	119
5.7.5 IP Camera Maintain	123
5.7.6 System Information	124
5.8 AI Scenario	127
5.8.1 Cross Counting	127
5.8.2 Face Attendance	138
Chapter 6 Search, Playback & Backup	140
6.1 Using Search Function	140
6.1.1 Search & Play Video in General	142
6.1.2 Event Search, Playback & Backup	144
6.1.3 Sub-periods Playback	147
6.1.4 Smart Search	148

6.1.5	Tag Search.....	150
6.1.6	Play External File.....	151
6.1.7	Picture Search & View	152
6.1.8	Slice Search	154
6.1.9	AI Search.....	155
Chapter 7	Remote Access via Web Client	166
7.1	Basic System Environment Requirements	166
7.2	Web Plugin Download and Installation	166
7.3	Web Client Manager.....	169
7.3.1	Live Interface.....	169
7.3.2	Playback	172
7.3.3	Remote Setting	175
7.3.4	Local Setting.....	175
Appendix	176
A.	Supported Hard Disk Drives	176
B.	Troubleshooting.....	177
C.	Usage Maintenance	179

SAFETY INSTRUCTION

Carefully read the following safety instruction so as to avoid personal injuries and prevent the equipment and other connection devices from being damaged.

1. Power sources

Never operate the equipment by using unspecified power supply.

2. Never push objects of any kind through openings of NVR

Never push objects of any kind through openings of NVR so as to avoid electric shock or other accidents.

3. Do not put the equipment in the dusty field

Do not put the equipment in the dusty field.

4. Do not place the equipment under rain or humid environment

Do not place the equipment under humid environment like basement. If the equipment is accidentally in contact with water, unplug the power cable and immediately contact your local dealer.

5. Keep the surface of the equipment clean and dry

Use soft damp cloth to clean the outer case of NVR (do not use liquid aerosol cleaners)

6. Do not operate if any problems are found

If there are any strange smell or sound from NVR, unplug the power cable and contact the authorized dealer or service center.

7. Do not try to remove the upper cover

Warning: Do not remove the cap of NVR so as to avoid electric shock.

8. Handle with care

If NVR does not work normally because of hitting on the hard object, contact the authorized dealer for repair or replacement.

9. Use standard lithium battery (Use the batteries attached or specified by the manufacturer)

After cutting off the power supply, if the system clock cannot continue to work, replace the standard 3V lithium battery on the main board.

Warning: Turn off NVR before replacing the batteries, or you may be suffered from serious electric shock. Properly dispose of the used batteries.

10. Put the equipment in a place with good ventilation

The NVR system includes HDD, which produces large amount of heat during operation. As a result, do not block the ventilation openings (on the top, bottom, both sides and the reverse side) for cooling the system during operation. Install or put the equipment in the place with good ventilation.

11. The attached power adapter can only be used for 1 set of NVR. Do not connect more equipment, or NVR may be restarted repeatedly because of insufficient power.

12. Prevent the equipment from water dropping or splashing. Do not place objects containing water, such as flower vase, on the equipment.

13. Do not ingest battery, Chemical Burn Hazard,

This product contains a coin / button cell battery.

If the coin / button cell battery is swallowed, it can cause severe internal burns in just 2 hours and can lead to death.

Keep new and used batteries away from children.

If the battery compartment does not close securely, stop using the product and keep it away from children.

If you think batteries might have been swallowed or placed inside any part of the body, seek immediate medical attention.

Chapter 1 Product Overview

1.1 Front View

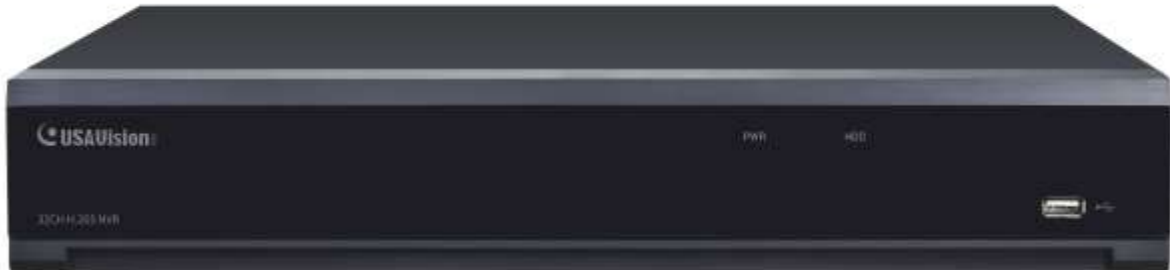

Item	Description
Power LED	Show constant green when power is supplied.
HDD LED	Show constant red when the HDD is connected. Flash red when recording or playback is enabled.
USB Port	Connect the supplied mouse or USB flash memory.

1.2 Rear View

1.2.1 UA-SNVR3240-N



Item	Description
Power Switch	Start up and shut down the NVR system.
Power Port	Connect the attached power supply.
USB Port	Connect a USB device, such as USB mouse and USB flash disk.
Sensor / Alarm / RS-485 Terminal Block	Connect to sensor, alarming devices, and/or RS-485 PTZ cameras.
Reset	Restore the device to its default settings. The reset hole is under the USB Port.
HDMI Port	Connect a HDMI-supported monitor.
VGA Port	Connect a VGA monitor, such as PC monitor.
LINE IN	Connect a microphone.
Audio Output	Connect a speaker.
WAN Port	Connect to an external network.
LAN Port	Connect to a router or switch for connecting cameras.

IMPORTANT: WAN and LAN ports are not linked, and the LAN port does not have the internet access. If you want to connect IP cameras to the LAN port to create a separate and local network, see [3.2 Connecting IP Cameras for UA-SNVR3240-N](#) in [UA-SNVR Quick Start Guide](#).

1.2.2 UA-SNVR1620-P



Item	Description
Power Switch	Start up and shut down the NVR system.
Power Port	Connect the attached power supply.
USB Port	Connect a USB device, such as USB mouse and USB flash disk.
Sensor / Alarm Terminal Block	Connect to sensor or alarming devices.
Reset	Restore the device to its default settings. The reset hole is under the USB Port.
HDMI Port	Connect a HDMI-supported monitor.
VGA Port	Connect a VGA monitor, such as PC monitor.
LINE IN	Connect a microphone.
Audio Output	Connect a speaker.
WAN Port	Connect to an external network.
LAN Port	Connect up to 16 cameras, with PoE supply.
RS-485 Terminal Block	Connect to a PTZ camera.

1.2.3 UA-SNVRL810-P



Item	Description
Power Switch	Start up and shut down the NVR system.
Power Port	Connect the attached power supply.
USB Port	Connect a USB device, such as USB mouse and USB flash disk.
Reset	Restore the device to its default settings. The reset hole is under the USB Port.
HDMI Port	Connect a HDMI-supported monitor.
VGA Port	Connect a VGA monitor, such as PC monitor.
Audio Output	Connect a speaker.
WAN Port	Connect to an external network.
LAN Port	Connect up to 8 cameras, with PoE supply.

Chapter 2 NVR Installation & Connection

2.1 HDD Installation

The number of 3.5" / 2.5" SATA hard drives that the NVR supports varies depending on the model. The following procedures are for reference only. The practical operation may be different depending on the NVR you purchased.

Caution: Do not install or remove the hard disk drive while the power is turned on.

- a)** Connect the data and power cables to the two hard disk drives and place the hard disk drives on the NVR case.
b) Carefully flip the NVR case and secure the hard disk drives to the NVR with the eight (8) screws.

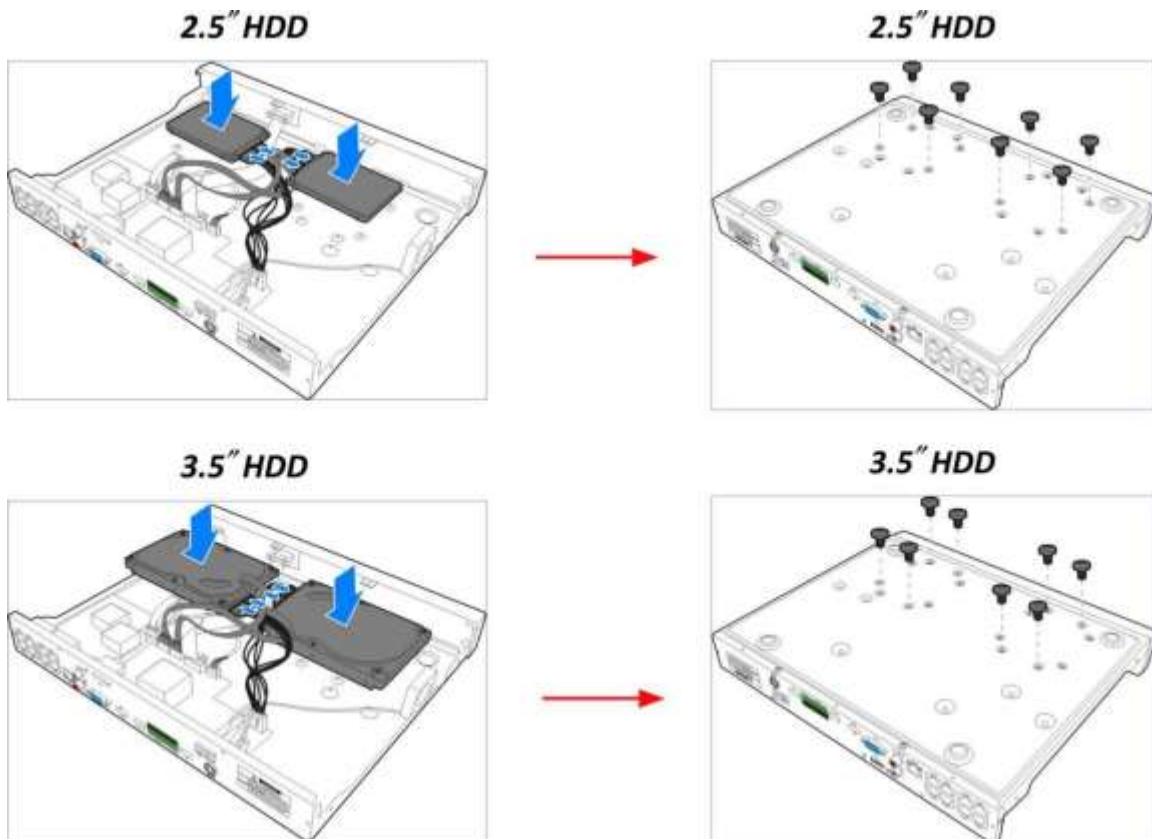

2.2 Connection Diagram

The following diagram is for reference only. The practical connection may be different depending on the NVR you purchased.

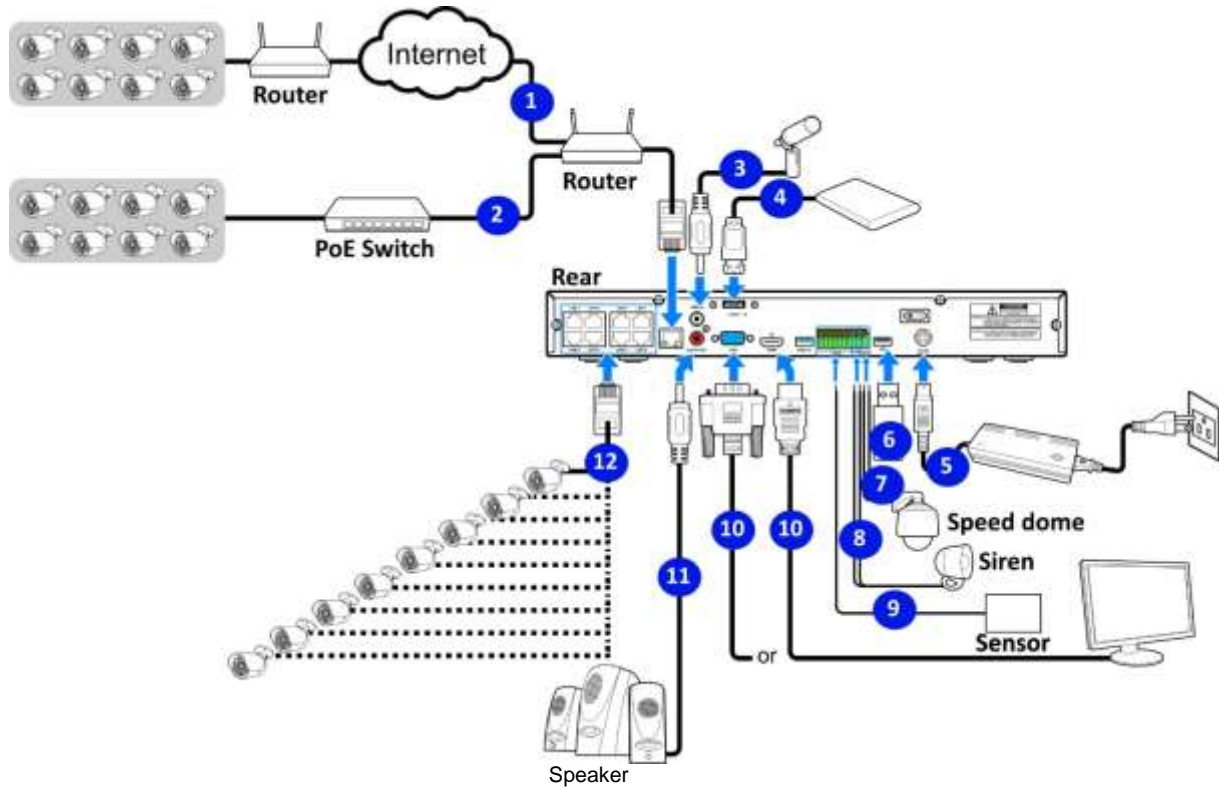

2.3 Power Supply Connection

Caution: Only use the supplied power adapter that comes with the NVR.

Connect one end of the power adapter to the power connector on the back of the NVR. Plug the other end of the power adapter into the wall outlet. And press the Power Switch to turn on the power.

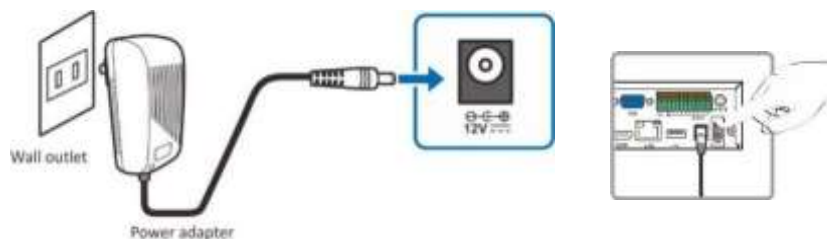

Chapter 3 NVR Common Operations

3.1 Using the Supplied Mouse

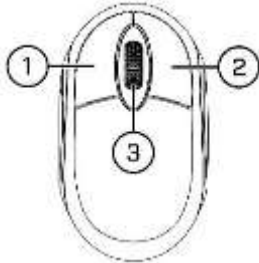

1. Left Button:

- Click to select menu options.
- During live viewing in split-screen view, double-click on a channel to view it in full-screen. Double-click the channel again to return to split-screen viewing.
- Click upon a channel on Live Viewing screen to open Camera Quick Toolbar.
- Click and hold to drag sliders and scales on menu mode

2. Right Button:

- Click once to open the Taskbar on the Live Viewing screen. View Taskbar on [4.2.2 Taskbar](#)
- In menus, click to go back / close menus.

3. Scroll Wheel:

- In menus, scroll to move up / down through the menu content.
- While hovering over the volume control wheel, scroll to turn system volume up / down.

3.2 Using the Virtual Keyboard

You will see the virtual keyboard automatically on the screen when you need to enter data

Click to toggle the keyboard to upper case and more punctuation



3.3 Password

For the first time when you run the NVR, you must be required to set your own password immediately in order to protect your privacy. Be sure to record your username and password and save them in a secure place.

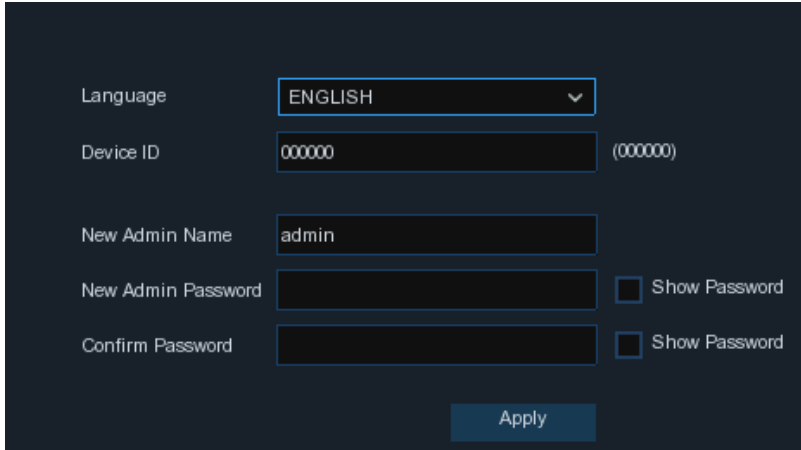

Language: Choose an OSD language

Device ID: Input the device ID in the parentheses. Default ID is 000000. View more about Device ID on [5.6.1 General](#).

New Admin name: To set your own administrator name.

New Admin Password: To set your own password. The password must be a combination of 8 characters.

Confirm Password: Enter your own password again.

Click **Apply** to confirm your settings and goes to the login interface. Enter your user name & password to **Login** the NVR system.

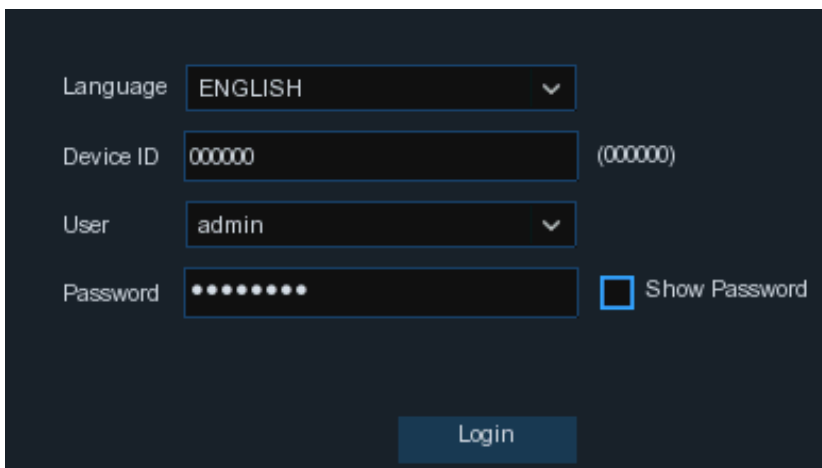

Note: If you forget your password, you will be unable to log in the system, contact our sales representative to reset the password.

Chapter 4 NVR Starting up

4.1 Start Wizard

Startup Wizard will help configure the system and get the NVR works quickly.

Note: The Start Wizard does not work for **UA-SNVR3240-N**. For the first-time users of this model, see [3.2 Getting Started for UA-SNVR3240-N](#) in [UA-SNVR Quick Start Guide](#).

4.1.1 Start Wizard

Click the **Start Wizard** to proceed to the next step



4.1.2 Network Configuration

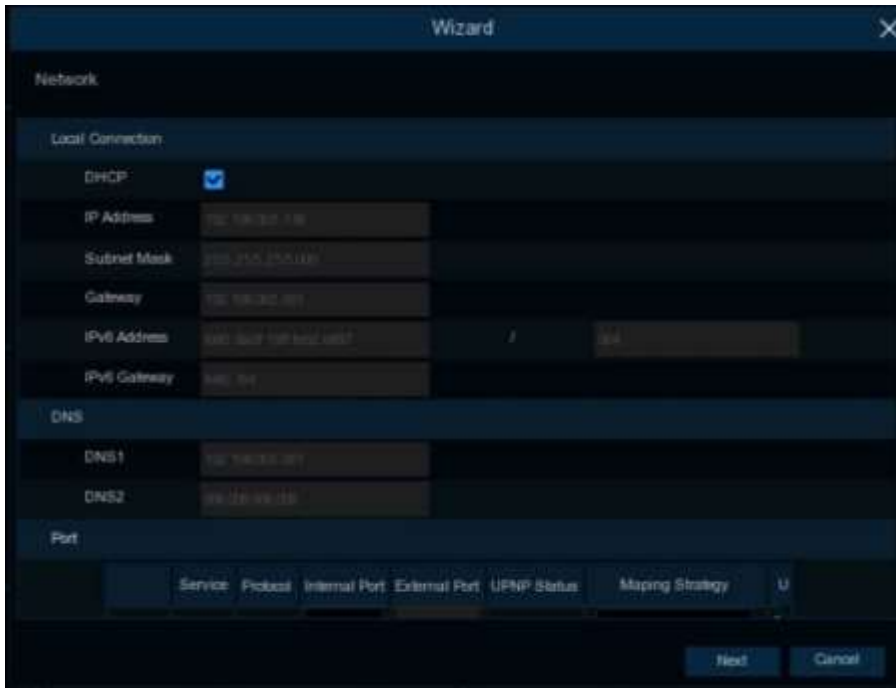

If you connect to a router allows to use DHCP, check the **DHCP** box. The router will assign automatically all the network parameters for your NVR. Unless the network is manually addressed below parameters:

IP Address: The IP address identifies the NVR in the network. It consists of four groups of numbers between 0 to 255, separated by periods. For example, “192.168.001.100”.

Subnet Mask: Subnet mask is a network parameter which defines a range of IP addresses that can be used in a network. If IP address is like a street where you live then subnet mask is like a neighborhood. The subnet address also consists of four groups of numbers, separated by periods. For example, “255.255.000.000”.

Gateway: This address allows the NVR to access the Internet. The format of the **Gateway** address is the same as the **IP Address**. For example, “192.168.001.001”.

DNS1/DNS2: DNS1 is the primary DNS server and DNS2 is a backup DNS server. Usually should be enough just to enter the DNS1 server address.

Port

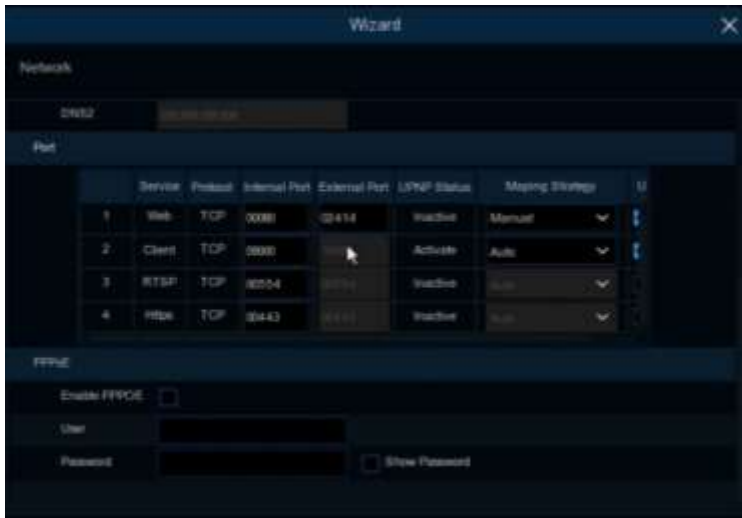

Web: This is the port that you will use to log in remotely to the NVR (e.g. using the Web Client). If the default port 80 is already taken by other applications, please change it.

RTSP: This is the port that the NVR will be allowed to transmit real-time streaming to other device (e.g. using a streaming Media player.).

Https: This is the port that you will use to log in remotely to the NVR by browsers with https protocol.

Internal Port: Used for LAN connection.

External Port: Used for WAN / Internet connection.

UPNP: If you want to log in remotely to the NVR using Web Client, you need to complete the port forwarding in your router. Enable this option if your router supports the UPnP. In this case, you do not need to configure manually port forwarding on your router. If your router does not support UPnP, make sure the port forwarding is completed manually in your router.

Mapping Strategy: If you want the port randomly distributed by the router UPNP server, choose "Auto"; If you want to manually forwarded the port, choose "Manual".

4.1.3 Date/Time

This menu allows you to configure the Date, Time, Date Format, Time Format, Time Zone, NTP and DST.

Date and Time

Click on the calendar icon to set the current system date.



Date: Click on the calendar icon to set the system date.

Time: Click to set the system time.

Date Format: Choose from the dropdown menu to set preferred date format.

Time Format: Choose time format between 24Hour and 12Hour.

Time Zone: Set the correct time zone.

NTP

NTP stands for Network Time Protocol. This feature allows you to synchronize the date and time automatically on the NVR over Internet. Therefore, the NVR needs to be connected to the Internet.

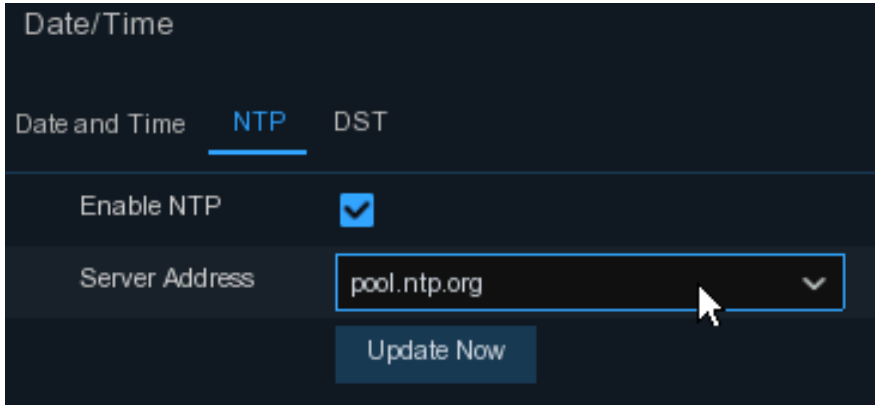

Check the “**NTP**” box, and select the NTP server.

DST

DST stands for Daylight Savings Time.

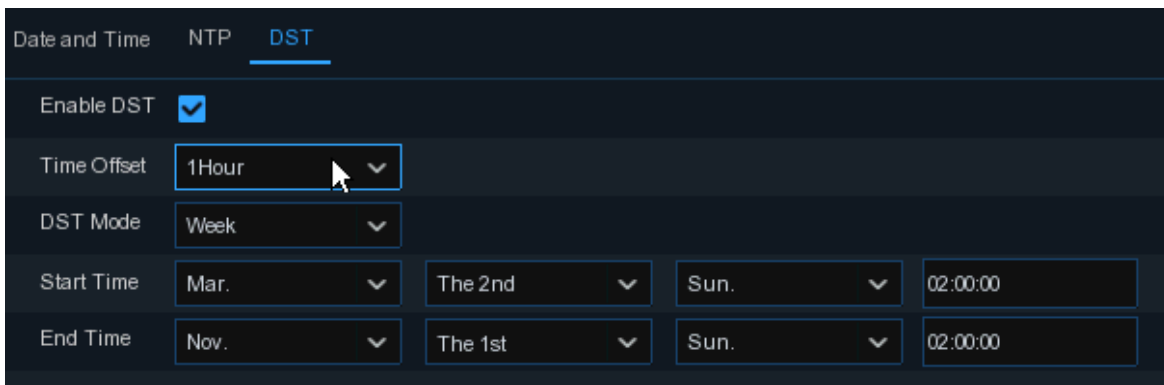

DST: Enable if Daylight Saving Time (DST) is observed in your region

Time Offset: Select the amount of time to offset for DST

Time Mode: Choose to set the daylight-saving time in weeks or in days

Start Time/End Time: Set the start time and end time for daylight saving

4.1.4 IP Camera

This menu allows you to add IP cameras to the NVR.

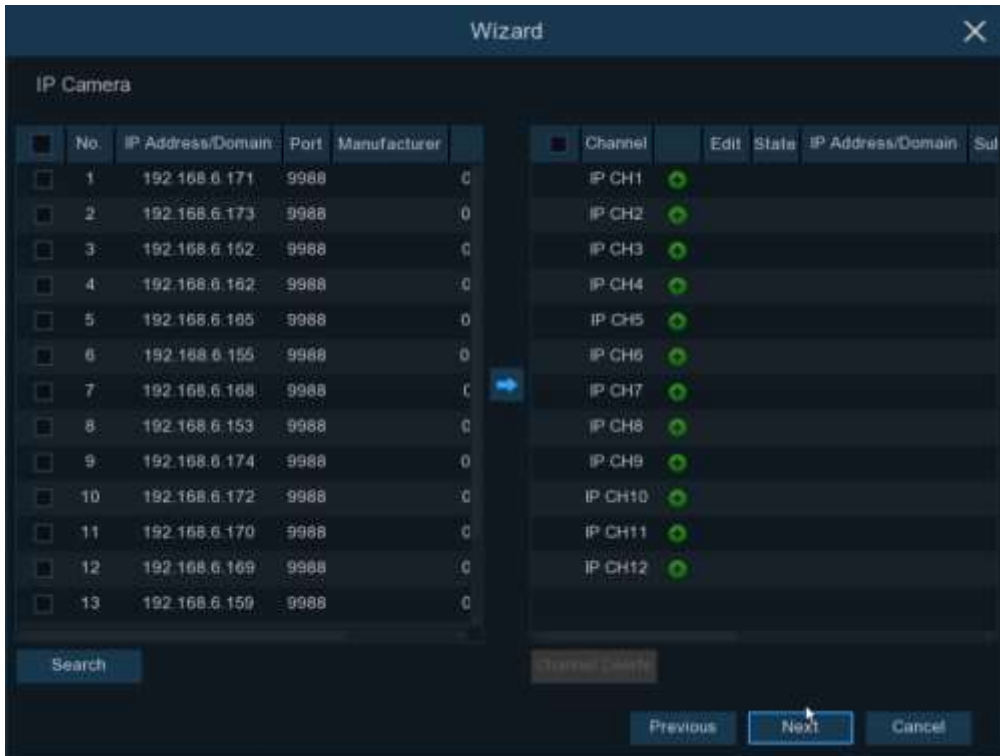

Click **Search** to search IP cameras in the same network. Choose the IP camera(s) you want to add, and then click  icon to add to the NVR.

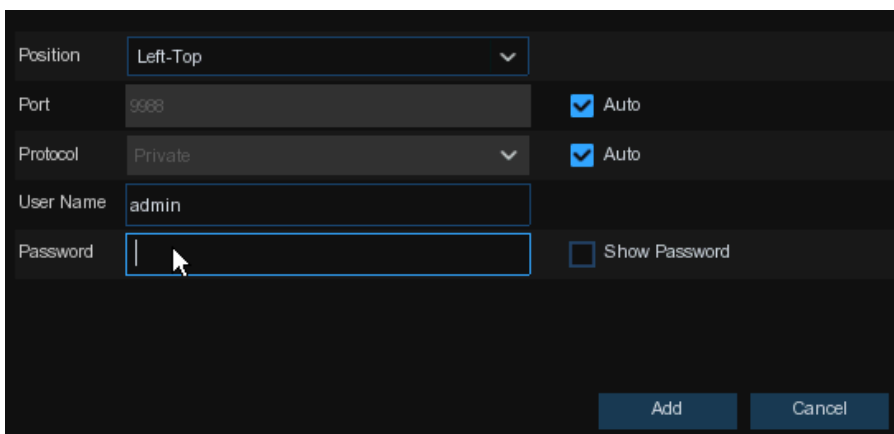

Enter the camera's user name & password to add the camera(s).
 You can also click  button to add individual IP camera to a single channel.



Click **Search** button to search IP cameras, and then click one of the IP cameras in the device list.

IP Address/Domain: IP address or domain name of the IP camera

Alias: Name of the IP camera

Position: Position to display the camera name on the screen.

Port: Port of the IP camera. It is set to 80 by default. Modify it if necessary.

Protocol: Choose the protocol of the IP camera from the dropdown menu

- Select **Onvif** for UA-B20004F / UA-B40004F / UA-B4000VF-S / UA-D20004F / UA-D40002F / UA-D4000VF-S / UA-R40002F-SA / GV-IP cameras
- Select **Private** for UA-B580F3 / UA-R500F2 / UA-R560F2 / UA-R580F2 / UA-R800F2
- Select **RTSP**, and type the commands as shown below:
 Main Stream: rtsp://IP address:port/rtsp/streaming?channel=xx&subtype=0
 Sub Stream: rtsp://IP address:port/rtsp/streaming?channel=xx&subtype=1

User Name: User Name of the IP camera

Password: Password of the IP camera

Bind channel: Choose a channel of the NVR you want to attach to

IMPORTANT:

1. The system fills in the ID and password using **admin/admin123**. for UA-B580F3 / UA-R500F2 / UA-R560F2 / UA-R580F2 / UA-R800F2 by default. Make sure to enter the correct ID and password of the IP cameras if the login credentials have been changed on the IP cameras before connecting to UA-SNVR models.
 2. The default password is **123456** for the following IP camera models: UA-B20004F / UA-B40004F / UA-B4000VF-S / UA-D20004F / UA-D40002F / UA-D4000VF-S / UA-R40002F-SA. To modify the password on the camera's Web interface, refer to [Network Cameras User Manual](#) for details.
-

4.1.5 Disk

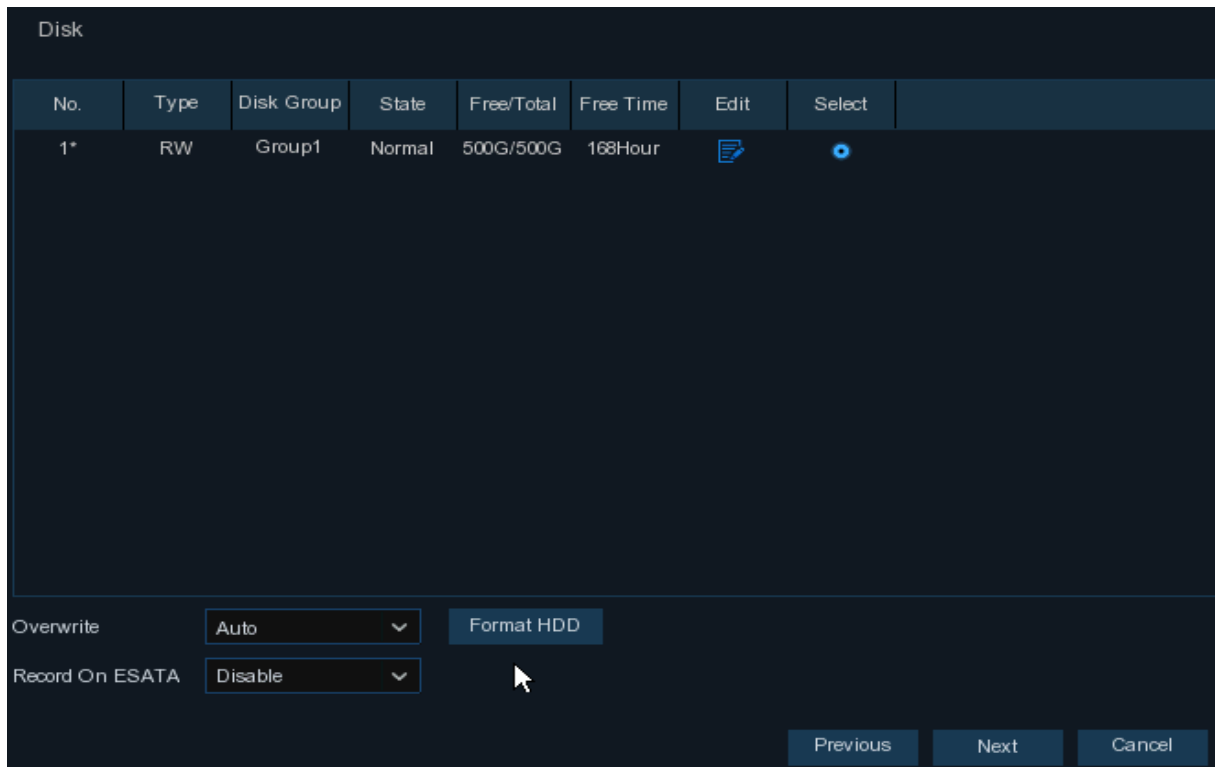

If the HDD is installed in the NVR for the first time, it must be formatted. Select the HDD and then click **Format HDD** button to format the HDD.

Overwrite: Use this option to overwrite the old recordings on the HDD when the HDD is full. For example, if you choose the option 7 days then only the last 7 days recordings are kept on the HDD. To prevent overwriting any old recordings, select Disable. If you have disabled this function, check the HDD status regularly, to make sure the HDD is not full.

Record On ESATA: If your NVR comes with an e-SATA port on the rear panel, you can enable to record the video to e-SATA HDD.

4.1.6 Resolution

Choose an output resolution matches to your monitor. The NVR supports to adjust the output resolution automatically to match the best resolution of your monitor when the system is starting up.

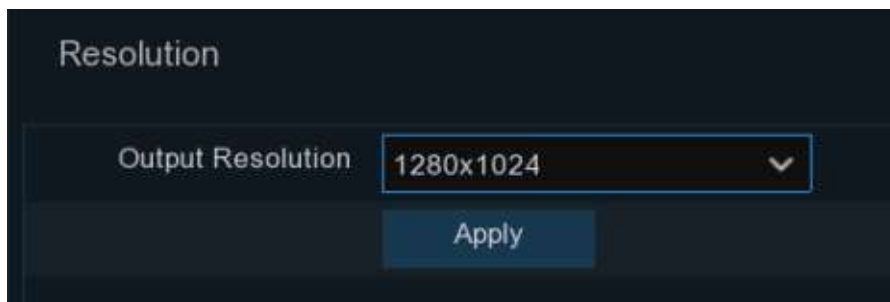

4.1.7 Mobile

If your NVR come with a P2P ID, you can scan the QR code with your mobile app to view the NVR remotely.



Note: The P2P function is only supported by GV-Eye V2.9.0 or later.

4.1.8 Summary

You can check the system summary information you had set in the start wizard and finish the wizard.

Tick **“Don't show this window next time”** if you don't want to display Start Wizard when system reboot next time. Click **Finish** button to save & exit.

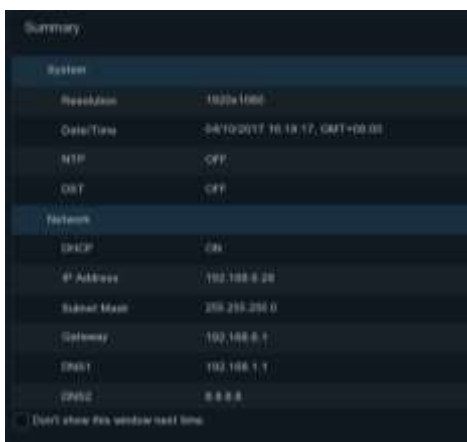

4.2 Live View Screen Overview

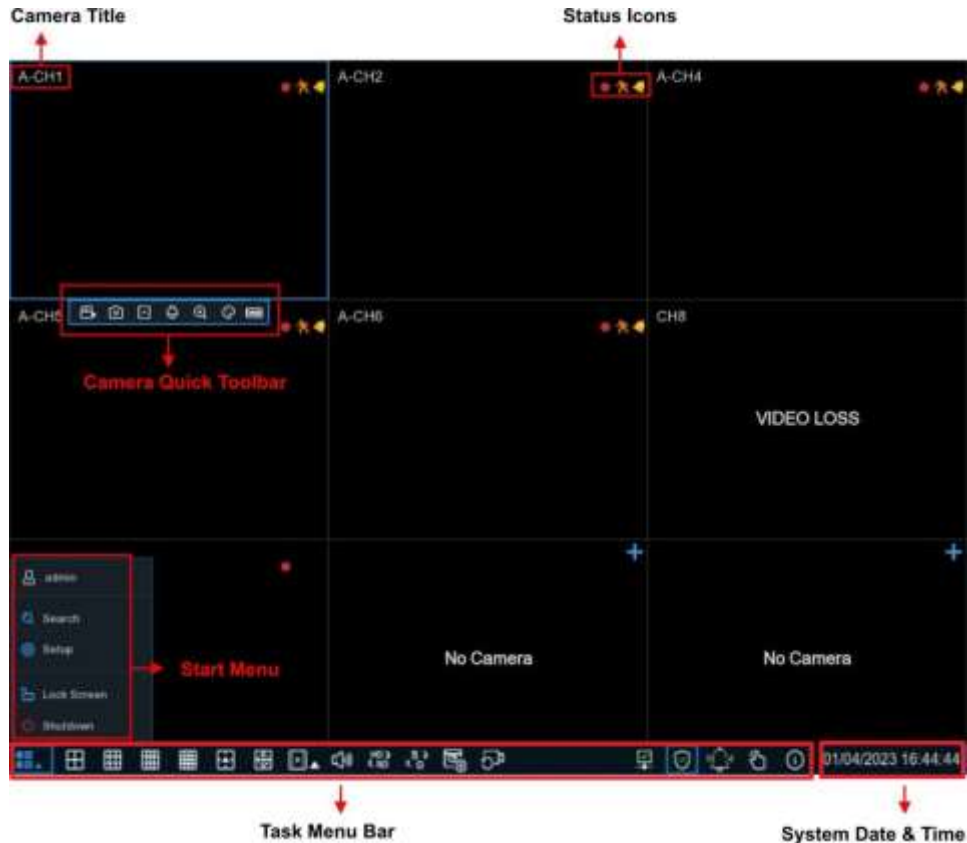

Camera Title

To display the camera title







A-: This indicates that the camera connected is an AHD camera

T-: This indicates that the camera connected is a TVI camera

C-: This indicates that the camera connected is a CVI camera

IP: This indicates that the camera connected is an IP camera

Status Icons

-  This indicates that the NVR is currently recording.
-  This icon appears when the camera has detected motion.
-  The icon indicates that the external I/O alarm device is triggered
-  This icon indicates that the HDD is in error to work
-  This icon indicates the HDD is unformatted
-  This icon indicates the HDD is full.
-  This icon indicates the HDD is read-only.

VIDEO LOSS: The analog camera is disconnected.

No Camera: IP camera is disconnected.

Decoding Failed: The NVR doesn't support this kind of IP camera compression standard, change to H.264 compression standard.

 Click to open **Quick Add** menu to add IP camera

 Click to edit current IP camera

4.2.1 Camera Quick Toolbar

In live viewing, click the left button of your mouse on a connected camera to display the Camera Quick Toolbar.





 Click to manually record the channel immediately. If the manually recording is in process, the icon will be in red color. Click one more time to stop manual record.

 Click to save a snapshot of the current camera image. Manual Capture must be enabled to use this feature. For details on enabling Manual Capture, see [5.2.3.1 Capture](#).

 Click to play the latest 5 minutes recording of this channel

 Click to enter PTZ control panel

 Click to zoom-in the channel. When the  icon appears, press and hold the left button of your mouse to drag the area you want to zoom in.

 Click to adjust the image color of the channel. You can adjust the HUE, BRIGHT, CONTRAST & SATURATION of the image.

 To switch the live view video stream between HD & SD. HD is mainstream live view, SD is substream live view.

4.2.2 Taskbar



Click to open the Start Menu



Click to choose different layout for live view



Click to choose more layouts for live view



Click to start viewing channels in a sequence



Quick playback. You can choose to play the latest recording for all channels from the beginning of the day, or you can choose the playback from the latest 5s, 10s, 30s, 1Min, 5Min.



Click to adjust audio volume



Click to switch all IP channels between mainstream and substream (for live view resolution)



Click to switch among real-time, balanced, or smooth view. The view effect modes affect only the live view video quality by bitrate and frame rate but do not affect the recording quality.



Click to restore the live view sequence.



Click to disarm / restore all alarms on the live view image at once.



To start or stop Manual Record and Manual Alarm.



To view system information, channel information, record info and network state.



This icon will appear if the network is disconnected.

4.2.3 Start Menu

With the start menu, you can switch user, search & playback, enter system setup menu, lock & unlock the screen, shut down, reboot & logout the system.

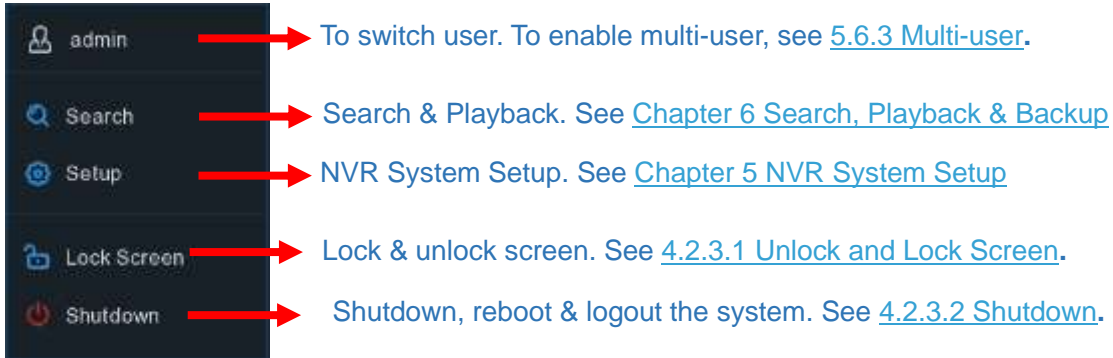

4.2.3.1 Unlock and Lock Screen

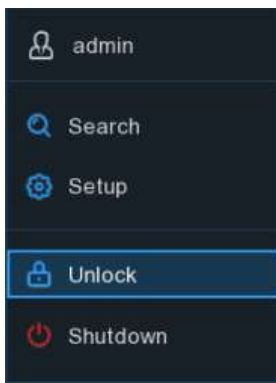

The screen will be locked to protect unauthorized OSD operation while the NVR is not in menu operation 1 minute.

If necessary, you can also lock the screen operation manually. To do so, go to Star Menu, and then click the Lock Screen icon  to lock the system immediately.

If the system is locked, you can click the Unlock icon  to unlock the system for further operation.

Note: To set up the duration of menu timeout or disable the timeout function, go to **General > System > Menu Timeouts**.

4.2.3.2 Shutdown

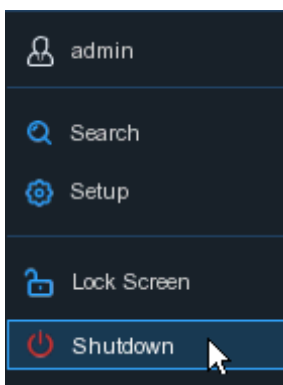

Click the **Shutdown** button from Star Menu, and then check the further action you want to move. Click **OK** button, system will require to input the Admin password to authenticate.

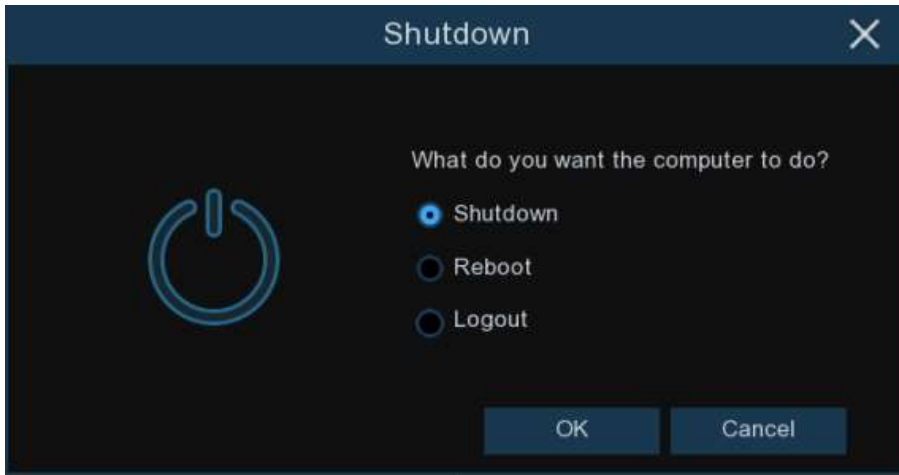

If you choose **Logout** the system, the live viewing screen will be disappeared. You will need to login the system for further operations.

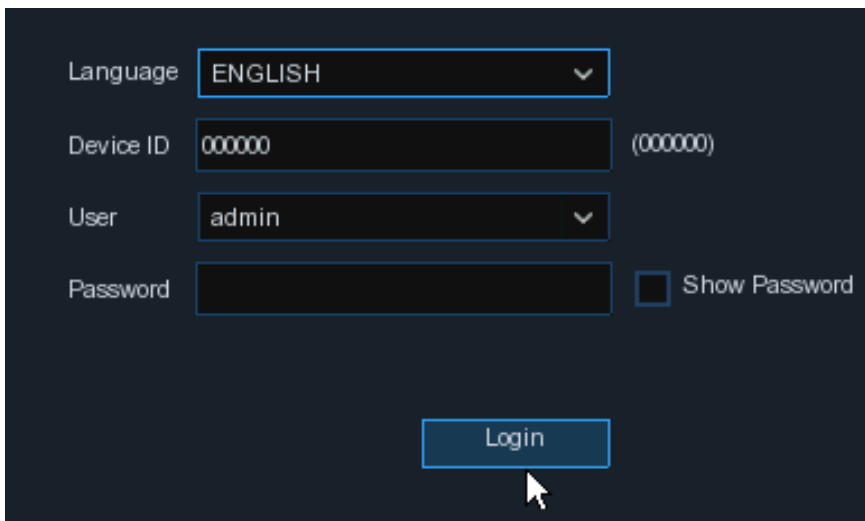

4.2.4 Fisheye Camera

After a fisheye camera is added to the device and the device goes online, the fisheye operation icon is displayed in the shortcut menu of the preview channel area and the playback menu. You

can click the  button to open the fisheye-mode operation page.

Note: This is only applicable to GV-RFER12700.



On the fisheye-mode operation page, click the  button on the toolbar at the bottom to open the menu for setting the fisheye camera installation mode. Then, select the mode in accordance with the actual installation mode, and save the setting to make it take effect.

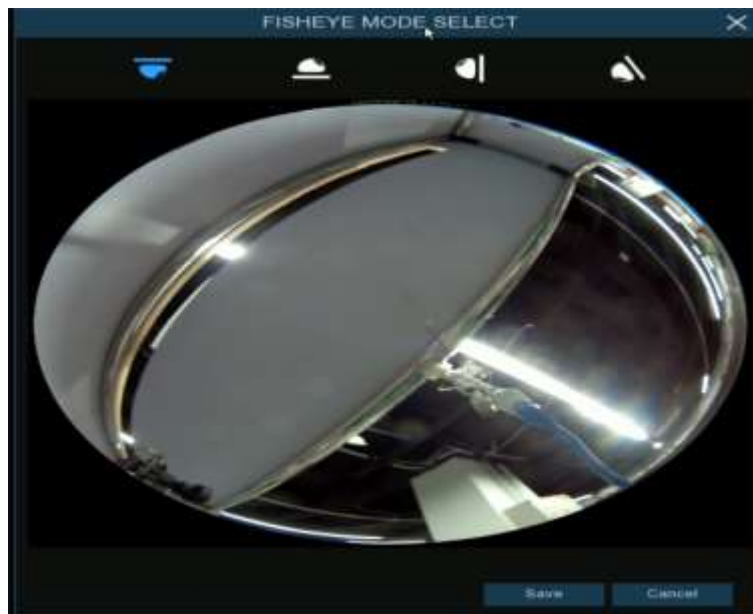

After the corresponding fisheye installation mode is set, the viewing modes supported in the selected installation mode are displayed on the toolbar at the bottom. You can switch the modes as needed and you can also drag and zoom the screen.



Note:

1. A maximum of 1 channel is supported for fisheye dewarping.
 2. Only Internet Explorer supports the fisheye dewarping function on the Web interface.
 3. Fisheye dewarping is not supported by playback recordings.
 4. Optionally, you can also adjust the camera mode to **Fisheye** to enable the dewarping function for your camera (**Channel > Channel > IP Cameras**, select **Edit** on the desired camera).
-

Chapter 5 NVR System Setup

You can configure the NVR for Channel, Record, Alarm, Network, Device & System from **Start Menu** → **Setup**.



5.1 Channel

In this section, you can configure the camera, live view display, manage IP cameras, adjust IP camera's image, PTZ setup, motion setup, convert mode, and more.

5.1.1 IP Channels

IMPORTANT: To add IP cameras, it is required to change the Switch Mode of one PoE camera from Auto to Manual in advance (**Edit > Switch Mode > Manual**).

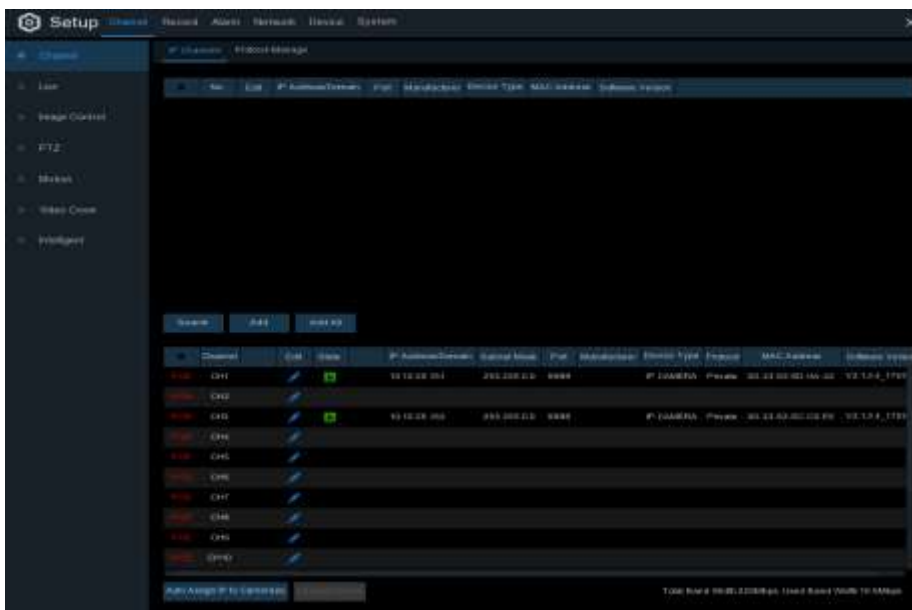

Click **Search** to search IP cameras from local network, click **Add** to add individual IP camera, click **Add All** to add all IP cameras.

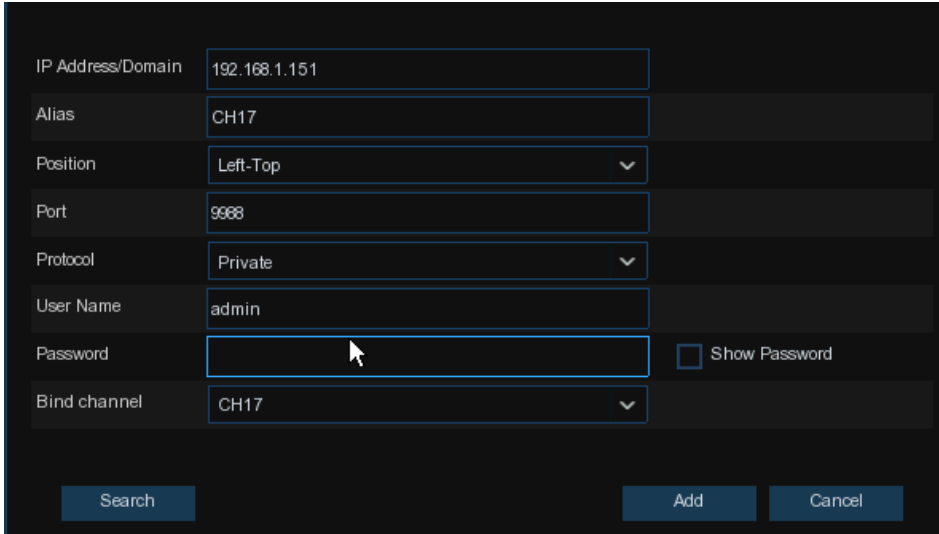

Click **Search** button to search IP cameras, and then click one of the IP camera in the device list.

IP Address/Domain: IP address or domain name of the IP camera

Alias: Name of the IP camera

Position: Position to display the camera name on the screen.

Port: Port of the IP camera. It is set to 80 by default. Modify it if necessary.

Protocol: Choose the protocol of the IP camera from the dropdown menu

- Select **Onvif** for UA-B20004F / UA-B40004F / UA-B4000VF-S / UA-D20004F / UA-D40002F / UA-D4000VF-S / UA-R40002F-SA / GV-IP cameras
- Select **Private** for UA-B580F3 / UA-R500F2 / UA-R560F2 / UA-R580F2 / UA-R800F2
- Select **RTSP**, and type the commands as shown below:

Main Stream: rtsp://IP address:port/rtsp/streaming?channel=xx&subtype=0

Sub Stream: rtsp://IP address:port/rtsp/streaming?channel=xx&subtype=1

User Name: User Name of the IP camera

Password: Password of the IP camera

Bind channel: Choose a channel of the NVR you want to attach to

Auto Assign IP to Camera(s): The added IP camera would be not able to connect if its IP address is not in the same network segment with NVR. With this function to reassign an IP address to all added IP cameras. This option does not work for **UA-SNVR3240-N**.

Channel Delete: Choose one or more added IP cameras, and click this button to delete.

5.1.2 Protocol Manage

With the Protocol Manage, you can edit your own RTSP protocol for IP camera connection.

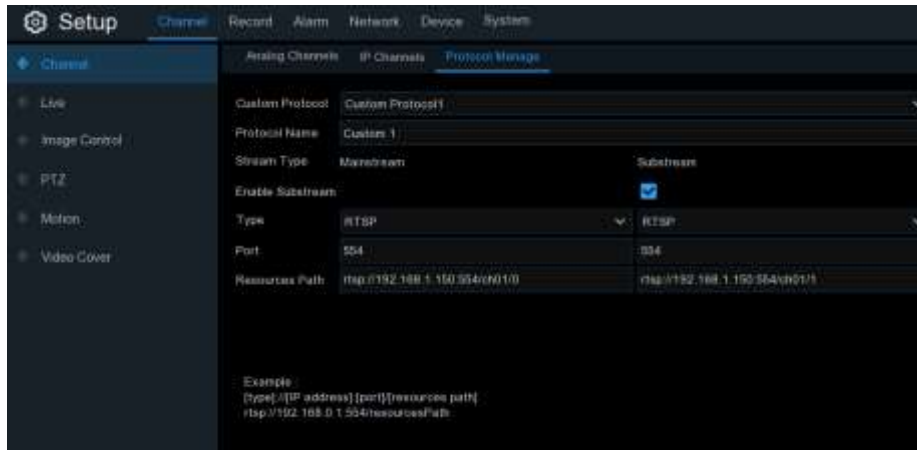

Custom Protocol: The system support max. 10 custom protocol options.

Protocol Name: To give a name to your custom protocol.

Enable Substream: Check the box if you want to enable sub-stream.

Type: Only RTSP available now.

Port: Input the RTSP port of your IP camera.

Resources Path: Input the RTSP address of your IP camera.

Note:

1. The Protocol Manage function is not supported by GV-SNVR3240-N.
2. The RTSP commands of the NVR are shown as below:
 For main stream display: `rtsp://IP address:port/rtsp/streaming?channel=xx&subtype=0`
 For sub stream display: `rtsp://IP address:port/rtsp/streaming?channel=xx&subtype=1`
3. For how to connect GV-IP Decoder Box Ultra to the NVR through RTSP, see the [technical notice](#).

5.1.2 Live

To configure camera parameters.

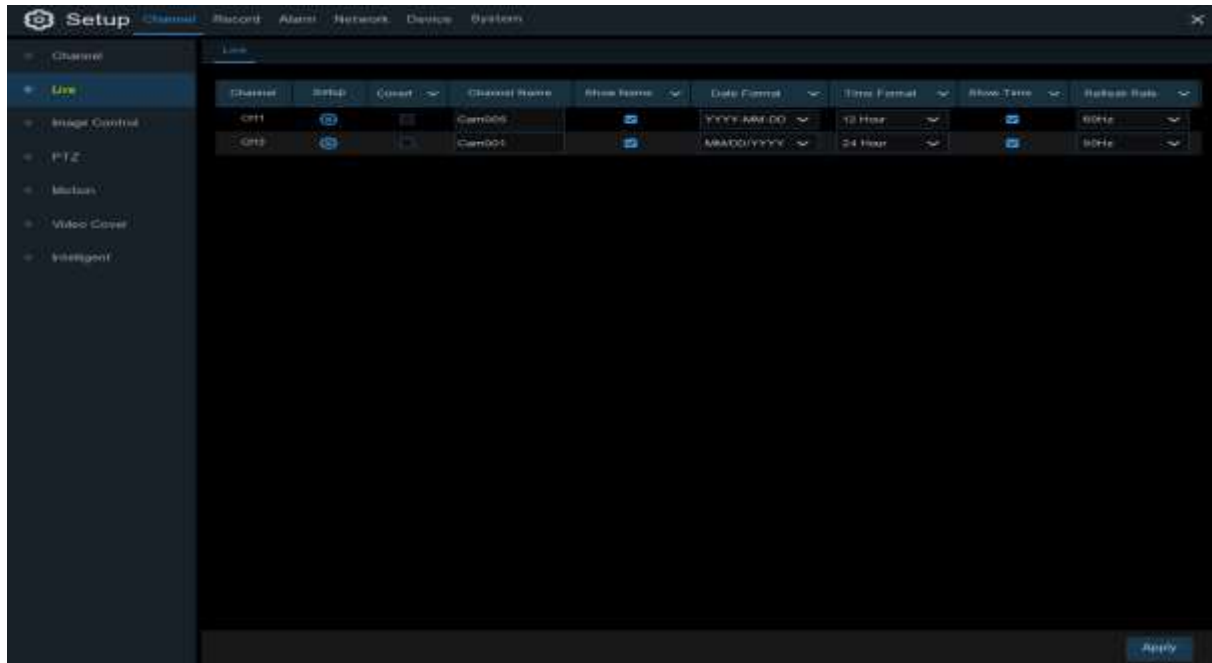

Channel: Display channel name.

Setup: Click  icon into the setup page.

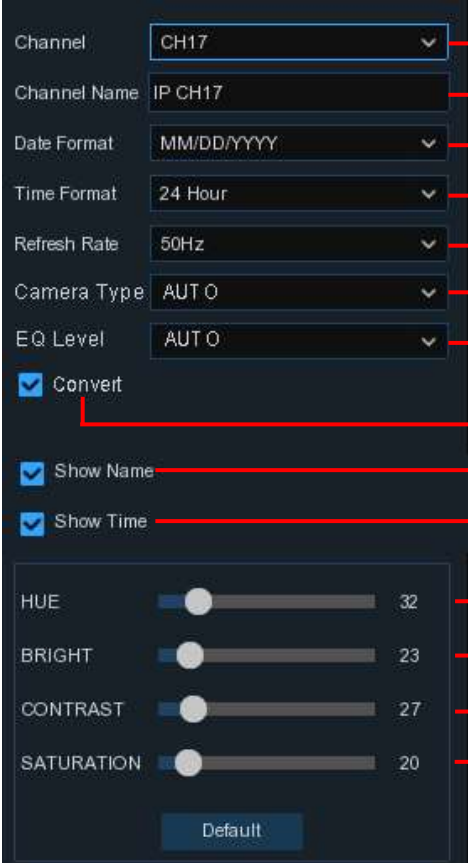

Channel: CH17 → Choose a channel to configure

Channel Name: IP CH17 → Give a name to the camera

Date Format: MM/DD/YYYY → Date format to display for the camera (for IP camera only)

Time Format: 24 Hour → Time format to display for the camera (for IP camera only)

Refresh Rate: 50Hz → Refresh Rate of the camera (for IP camera only)

Camera Type: AUT O → Choose a camera type (Auto, AHD, TVI, CVI) for analog camera

EQ Level: AUT O → Choose an AHD EQ (Enhanced Quality) level depends on your camera video cable

Convert → Check the box If you want to hide the live image of this channel

Show Name → To show the camera name in live view screen

Show Time → To show the system time in live view screen

HUE: 32 → Adjust the Hue value for the image color

BRIGHT: 23 → Adjust the Bright value for the image color

CONTRAST: 27 → Adjust the Contrast value for the image color

SATURATION: 20 → Adjust the Saturation value for the image color

Default

Click **Default** to load default settings, click **Apply** to save settings, click right buttons of your mouse to exit.

5.1.3 Image Control

This menu allows you to control image settings for supported IP cameras.

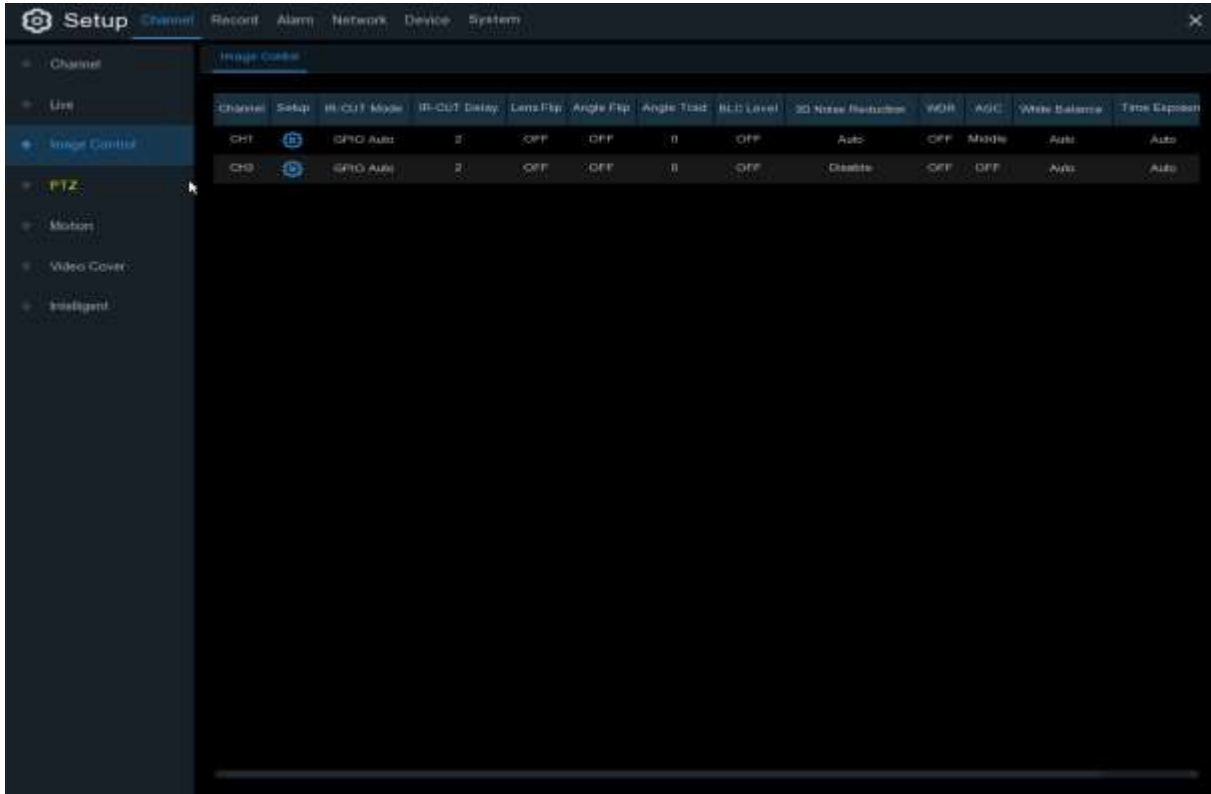

Channel: Channel name.

Setup: Click  icon into the setup page.

Channel	CH17	▼	→ Choose a channel to configure
IR-CUT Mode	GPIO Auto	▼	→ Select the desired built-in IR cut filter mode to ensure the camera works properly both in the day and night.
IR-CUT Delay	<input type="range" value="2"/>	2	→ Set the delay time of IR-CUT switching
<input type="checkbox"/> Lens Flip	<input type="checkbox"/> Angle Flip		→ Check to enable lens flip and angle flip
Angle Trad	0	▼	→ Set the flip angle
Back Light	Enable	▼	→ To enable or disable Backlight compensation
BLC Level	Low	▼	→ Choose the backlight compensation level
3D Noise Reduction	Auto	▼	→ To enable or disable 3D noise reduction function
Level	<input type="range" value="128"/>	128	→ Set the 3D noise reduction level
WDR	Enable	▼	→ Enable to allow automatically adjust the brightness and contrast of the video when shooting in the darkness with bright light sources.
Level	<input type="range" value="128"/>	128	→ Set the WDR level
AGC	Middle	▼	→ Automatic Gain Control
White Balance	Auto	▼	→ Configure white balance
Shutter	Auto	▼	→ Set the shutter mode
Time Exposure	1/8	▼	→ Choose the exposure time of the camera
Defog Mode	Auto	▼	→ Use in foggy environments to improve the video quality

5.1.4 PTZ

This menu allows you to configure the PTZ (Pan-Tilt-Zoom) settings for the dome camera

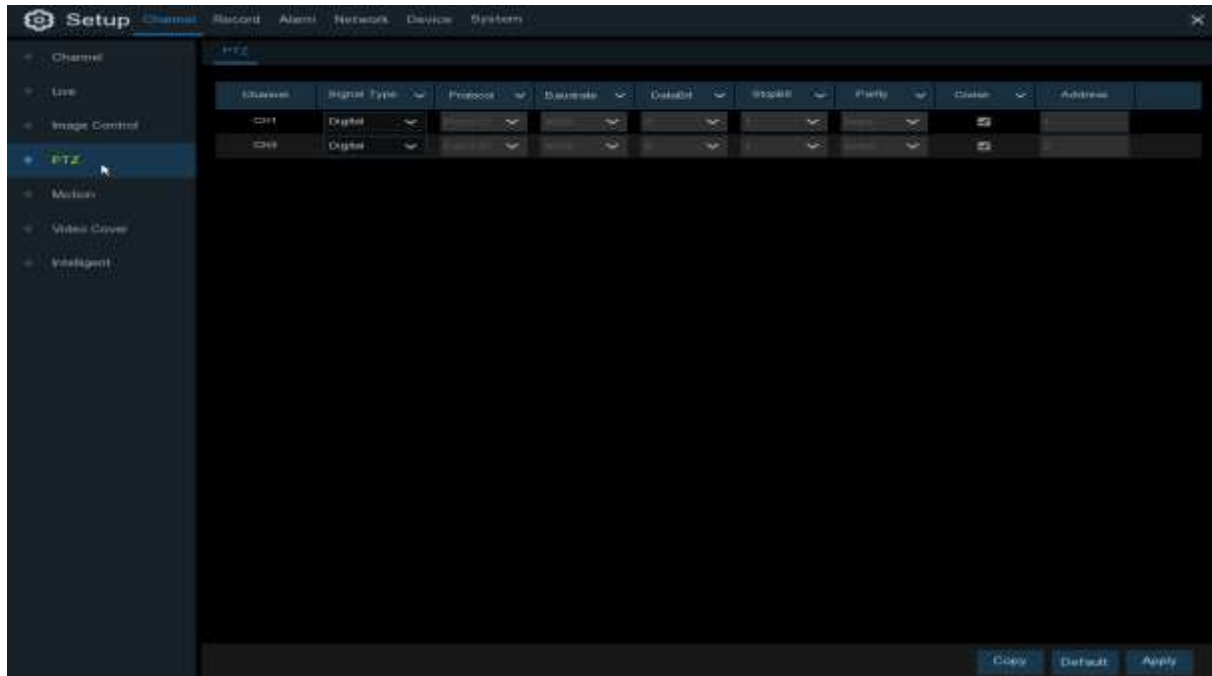

Channel: Channel name

Signal Type: Analog for analog channels, Analog & Digital for IP channels.

Protocol: Choose the communication protocol between the PTZ capable camera and NVR. If your camera support UTC (Up the Coax) function, you can choose COAX1 or COAX2 to display your camera OSD menu or control the UTC PTZ function.

Baudrate: The speed of the information sent from the NVR to the PTZ-capable camera. Make sure it matches the compatibility level of your PTZ-capable camera.

DataBit / StopBit: The information between the NVR and PTZ-capable camera is sent in individual packages. The **DataBit** indicates the number of bits sent, while the **EndBit** indicates the end of the package and the beginning of the next (information) package. The available parameters for **DataBit** are: **8, 7, 6, 5**. the available parameters for the **StopBit** are **1 or 2**.

Parity: For error check. See the documentation of your PTZ-capable camera, to configure this setting.

Cruise: Enable to use the Cruise mode. In order to use the Cruise mode, you need to set a number of preset points.

Address: Set the command address of the PTZ system. Be noted that each PTZ-capable camera needs a unique address to function properly

5.1.4.1 PTZ control

After finishing the PTZ setup, you can use the PTZ function to control your PTZ camera.

- 1) Click left your mouse upon a channel on Live Viewing screen to open [Camera Quick Toolbar](#), and choose the PTZ control icon .
- 2) PTZ control panel will be displayed.





Item	Description
Channel	Click to select the channel of the PTZ camera.
Mode	Click to select PTZ or preset mode.
Pointer Panel	A) Click the direction arrow to select the direction of the PTZ camera. B) Click up / down / left / right arrow to move cursor in UTC OSD menu. C) Click  to switch to auto pan mode.
Speed	Adjust the PTZ speed.
Zoom	Click to zoom in / out.
Focus	Click to adjust the focus.
Iris	Click to adjust the iris setting (if the device supports).
Total	Display the total number of preset points.

Start Cruise	Start PTZ cruise by preset points.
No	Number of preset points.
Name	Name of preset points.
Time	Set the time duration for the camera to stay in the preset point.
GO TO	Click to move your PTZ camera to the preset point.
Add	Click to add preset points.
Clear	Click to delete the selected preset point.

5.1.5 Motion

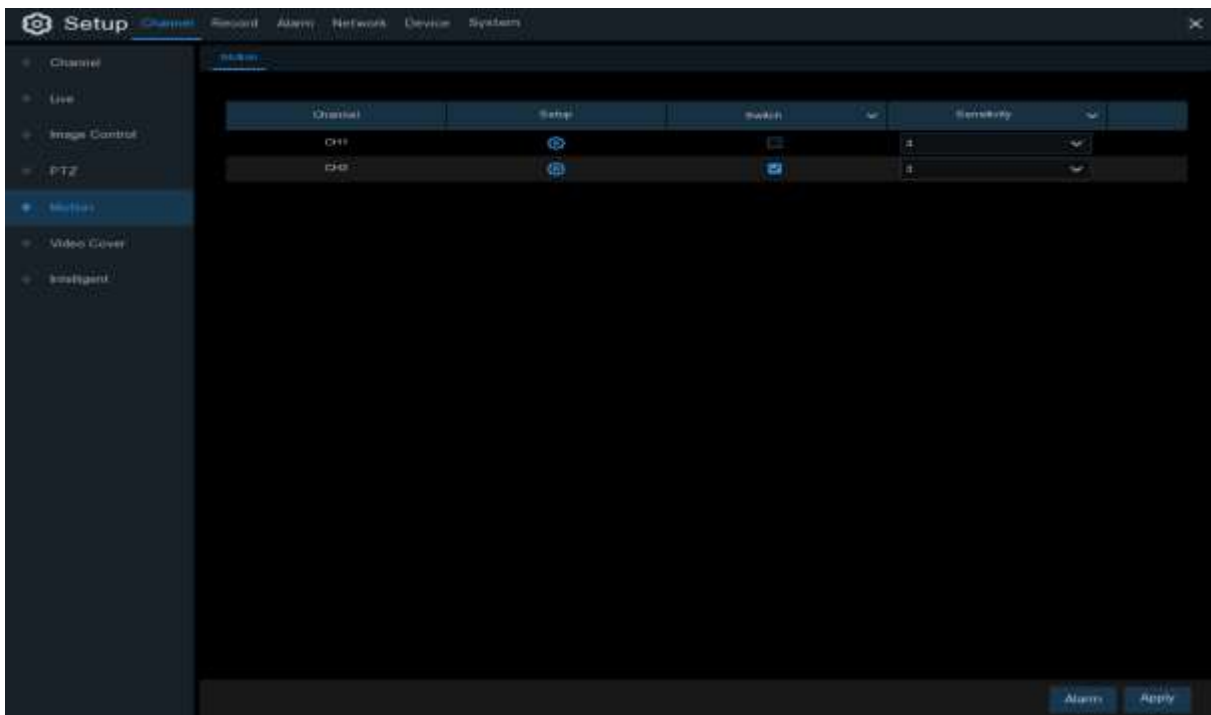
This menu allows you to configure motion parameters. When motion has been detected by one or more cameras, your NVR will alert you to a potential threat at your home. It does this by sending you an email alert with an attached image from the camera to use as a reference (if this option is enabled) and/or sending push notifications via the mobile app.



Setup: Click  icon into the setup page.

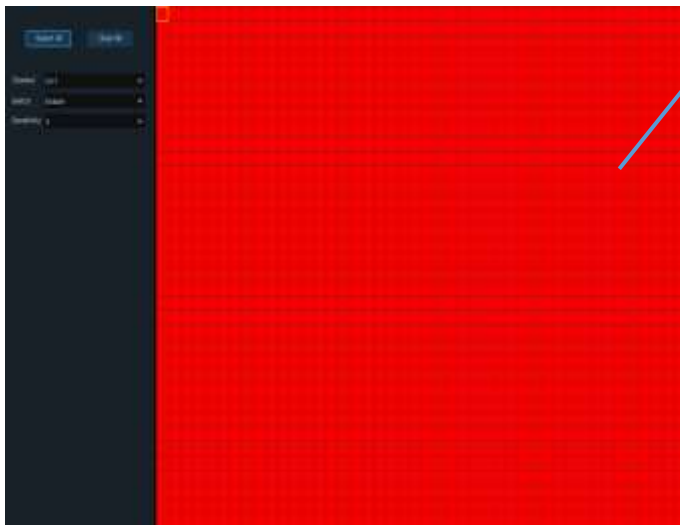

Motion Detection Area:

The whole screen is marked for motion detection (red blocks) as default. If you want to disable the motion detection on a certain area, click the grid cursor and then drag the mouse to highlight the scope to unmark the area into transparent blocks. After setting is completed, click the right button of your mouse to return and click **Save** to make the area setup effective.

Switch: Enable or disable motion detection.

Sensitivity: Set the sensitivity level. Level 1 the lowest sensitivity level while level 8 is the highest sensitivity level.

5.1.6 Video Cover

This menu allows you to create privacy zone(s) if you want to partially cover some certain part of the image. You can create up to 4 privacy zones in any size and location on the camera image. Enable the Privacy Zone, and choose how many zones you need. The zone(s) appear as “red box”. Click the edge of the red box and drag it to any size to create a privacy zone.

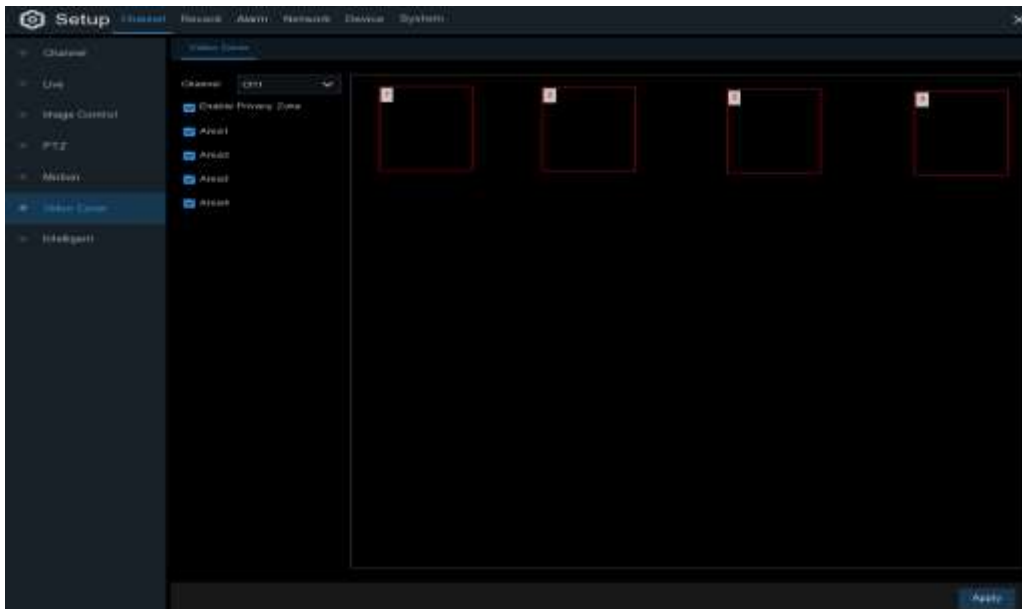

Note: The areas of privacy zones set will be invisible in both live view & recording video.

5.1.7 Intelligent

The intelligent analysis functions include **SOD (Stationary Object Detection)** and **Sound Detection**. These functions are only supported by the AI-capable UA-IP cameras listed below with UA-SNVR3240-N / UA-SNVRL810-P. Make sure to upgrade your camera to the latest firmware.

- UA-B580F3
- UA-R560F2
- UA-R580F2
- UA-R800F2

Note:

1. To properly connect to the IP cameras, make sure to use the correct port (**9000**) and protocol (**Private**). See *4.1.4 IP Camera* for details.
2. To configure AI functions of UA-SNVR3240-N, including **FD (Face Detection)**, **PD & VD (Pedestrian and Vehicle Detection)**, **PID (Perimeter Intrusion Detection)**, **LCD (Line Crossing Detection)**, **CC (Cross Counting)**, **HM (Heat Map)**, **CD (Crowd Density Detection)**, **QD (Queue Length Detection)**, **LPD (License Plate Detection)**, **RSD (Rare Sound Detection)** and **FR (Face Recognition)**, see *5.4 AI*.

5.1.7.1 SOD (Stationary Object Detection)

Stationary Object Detection function detects the objects left over or lost in the pre-defined region such as the baggage, purse, dangerous materials, etc., and a series of actions can be taken when the alarm is triggered.

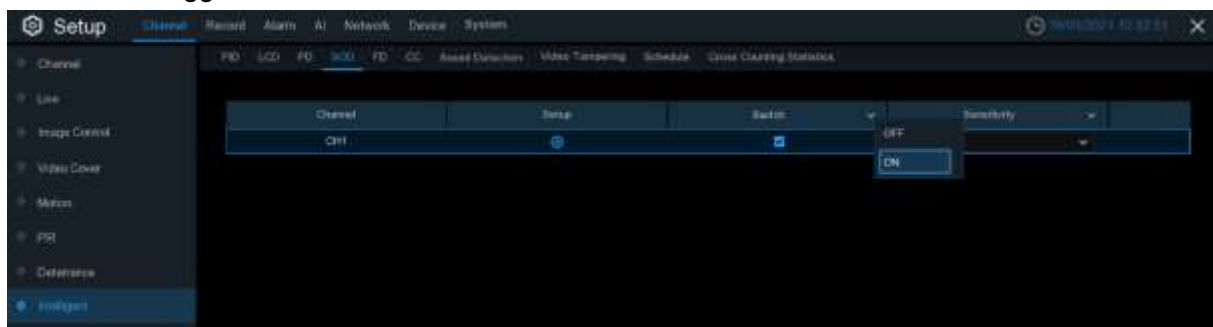

Switch: Check the box to enable SOD function.

Sensitivity: Set the sensitivity level. Level 1 the lowest sensitivity level while level 4 is the highest sensitivity level.

Click **Setup** icon  to draw a virtual region in the camera image.

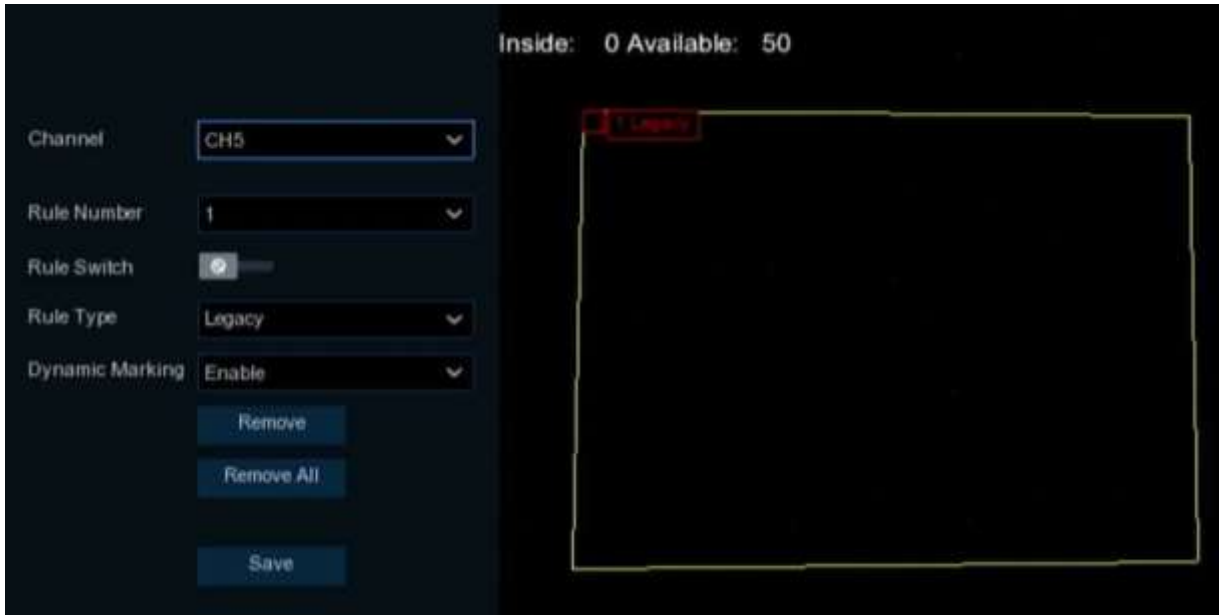

Channel: Select the channel you want to configure

Rule Number: Max. 4 rules available.

Rule Switch: Activate or inactivate the rule

1. Choose one of the **Rule Number**. It is the number of SOD area. Maximum 4 areas you can set for SOD function.
2. To enable the detection in **Rule Switch**.
3. Choose a **Rule Type**.
 Legacy: NVR will only detect the left-over objects;
 Lost: NVR will only detect the lost objects;
 Lost & Legacy: NVR will detect both left-over & lost objects.
4. Use your mouse to click 4 points in the camera picture to draw a virtual region. The shape of the region should be a convex polygon. Concave polygon is not applicable.
5. Click **Save** to save your settings.
6. If you want to adjust the size of the region, click the red box in the region, the borders of the region will be changed to red color. Long press the left button of your mouse to move the whole region, or drag the corners to resize the region.
7. If you want to remove one of the regions from the camera picture, click the red box in the region and then click **Remove** button. Click **Remove All** will delete all regions.

Notice:

- 1) The detection area shall be greater than or equal to the size of the detected object, such as the detection of a white bottle.
- 2) The detected object cannot be covered.



For Alarm setup, please refer to [5.3.3 Intelligent](#).

For Schedule setup, please refer to [5.1.8.3 Schedule](#).

5.1.7.2 Sound Detection

With the sound detection, it can trigger an alarm while detecting the sound rise or decline, and some certain actions can be taken when the alarm is triggered.

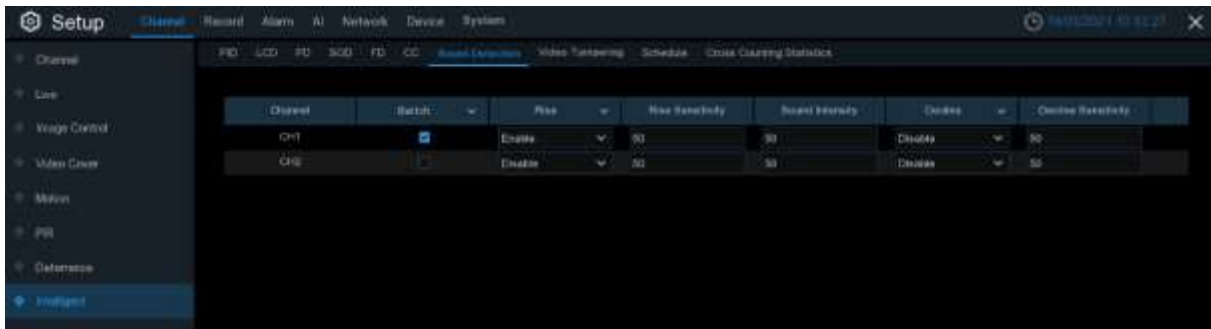

Switch: Enable or disable sound detection.

Rise: Enable or disable sound rise detection.

Rise Sensitivity: Set the sensitivity level. Level 1 the lowest sensitivity level while level 100 is the highest sensitivity level.

Sound Intensity: Set a threshold of sound intensity, the lower value, the more sensitivity.

Decline: Enable or disable sound Decline detection.

Decline Sensitivity: Set the sensitivity level. Level 1 the lowest sensitivity level while level 100 is the highest sensitivity level.

For Alarm setup, please refer to [5.3.3 Intelligent](#)

For Schedule setup, please refer to [5.1.8.3 Schedule](#).

5.1.7.3 Schedule

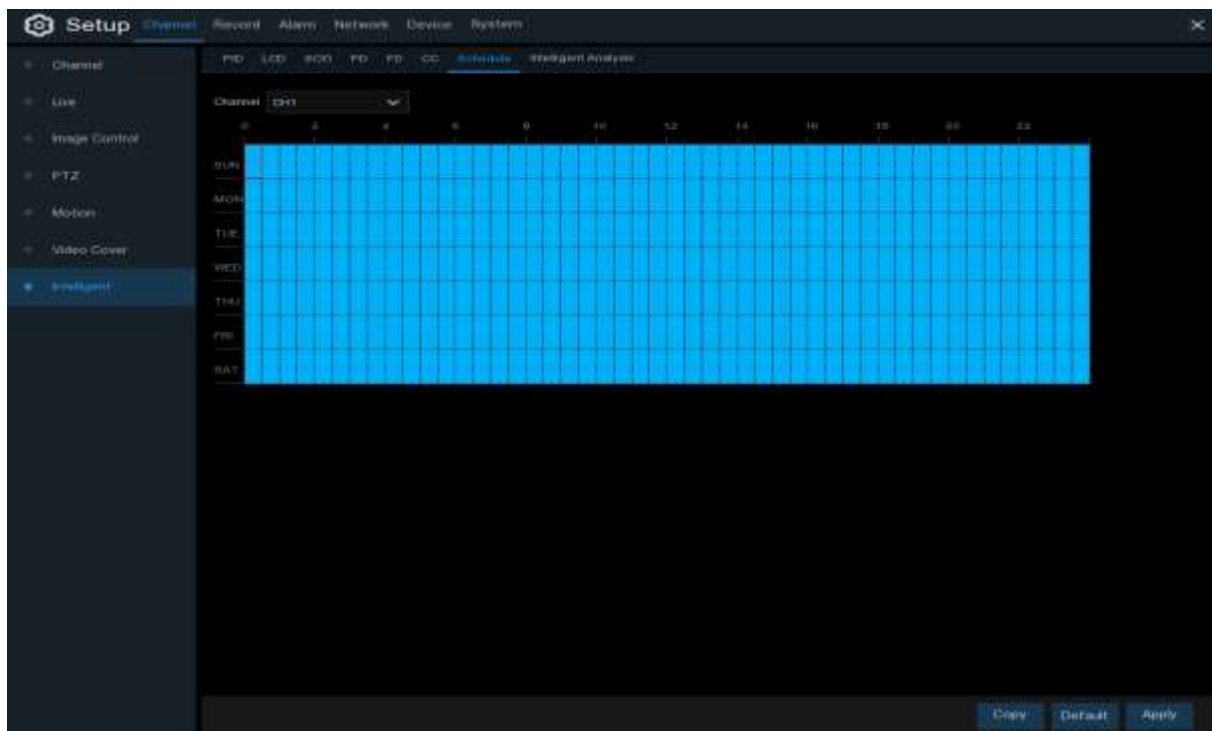

In order to activate the intelligent function, you need to config the schedule. The schedule will be active in 24 hours x 7 days.

To set the schedule, choose one channel then drag the cursor to mark the slots. The sky-blue blocks in the time slots will be active for Intelligent detections. The schedule is valid only for the selected channel each time when you set. If you want to use the same schedule for other channels, use **Copy** function. Click **Save** to save your settings.

5.2 Record

This menu allows you to configure the recording parameters

5.2.1 Encode

This menu allows you to configure the recording video or network transmission picture quality. Generally, Mainstream defines the recording video quality which will be saved in the HDD; Substream defines the video quality which is being viewed via remote access, for example web client & CMS; Mobilestream defines the video quality which is being viewed via remote access via mobile devices.

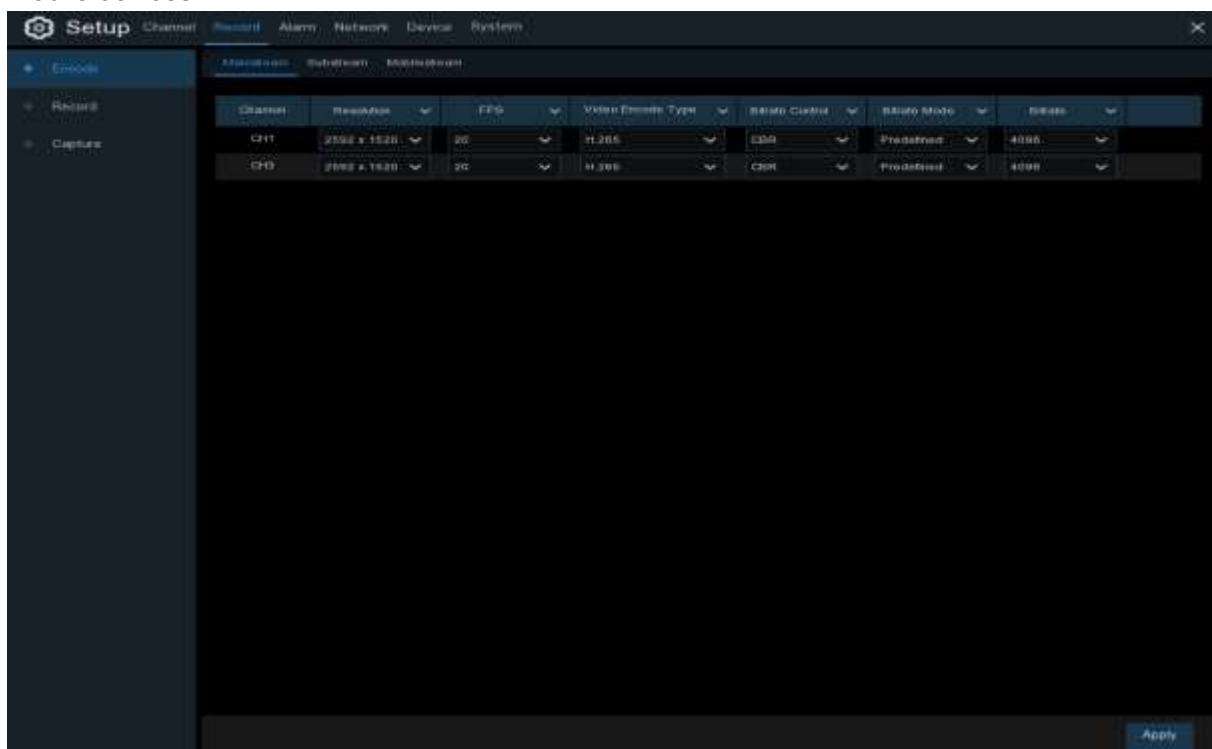

Resolution: This parameter defines how large the recorded image will be.

FPS: This parameter defines the number of frames per second the NVR will record.

Video Encode Type: For IP camera only. NVR support H.264 IP camera only. If you choose H.265, live view screen of the IP channel will display “[Decoding Failed](#)”.

Bitrate Control: Select the bitrate level. For a simple scene, such as a gray wall is suitable constant bitrate (**CBR**). For more complex scene, such as a busy street is suitable variable bitrate (**VBR**).

Bitrate Mode: If you want to set the bitrate by yourself, then choose **User-defined** mode. If you want to select the predefined bitrate, choose **Predefined** mode.

Bitrate: This parameter corresponds to the speed of data transfer that the NVR will use to record video. Recordings that are encoded at higher bitrates, will be of better quality.

5.2.2 Record

This menu allows you to configure the channel recording parameters.

5.2.2.1 Record

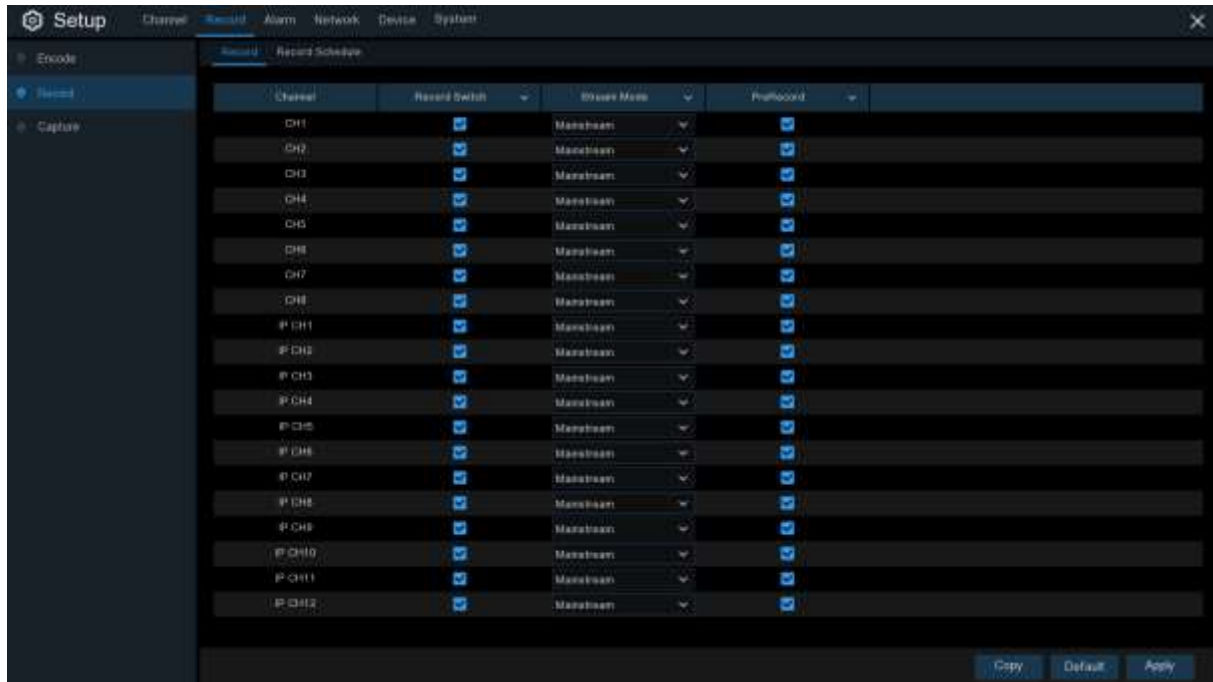

Record Switch: Check to enable the recording in this channel.

Stream Mode: Choose the recording quality. If you choose Dualstream, the system will record in both Mainstream & Substream.

PreRecord: If this option is enabled, the NVR starts recording a few seconds before an alarm event occurs. Use this option if your primary recording type is motion or I/O alarm based.

5.2.2.2 Record Schedule

This menu allows you to specify when the NVR records video and defines the recording mode for each channel. The recording schedule lets you set up a schedule like, daily and hourly by normal (continuous) recording, motion recording, I/O alarm recording & PIR recording (if your NVR supports). To set the recording mode, click first on the mode radio button (Normal, Motion, IO, PIR), then drag the cursor to mark the slots. The recording schedule is valid only for one channel. If you want to use the same recording schedule for other channels, use **Copy** function. Click **Apply** to save your settings.

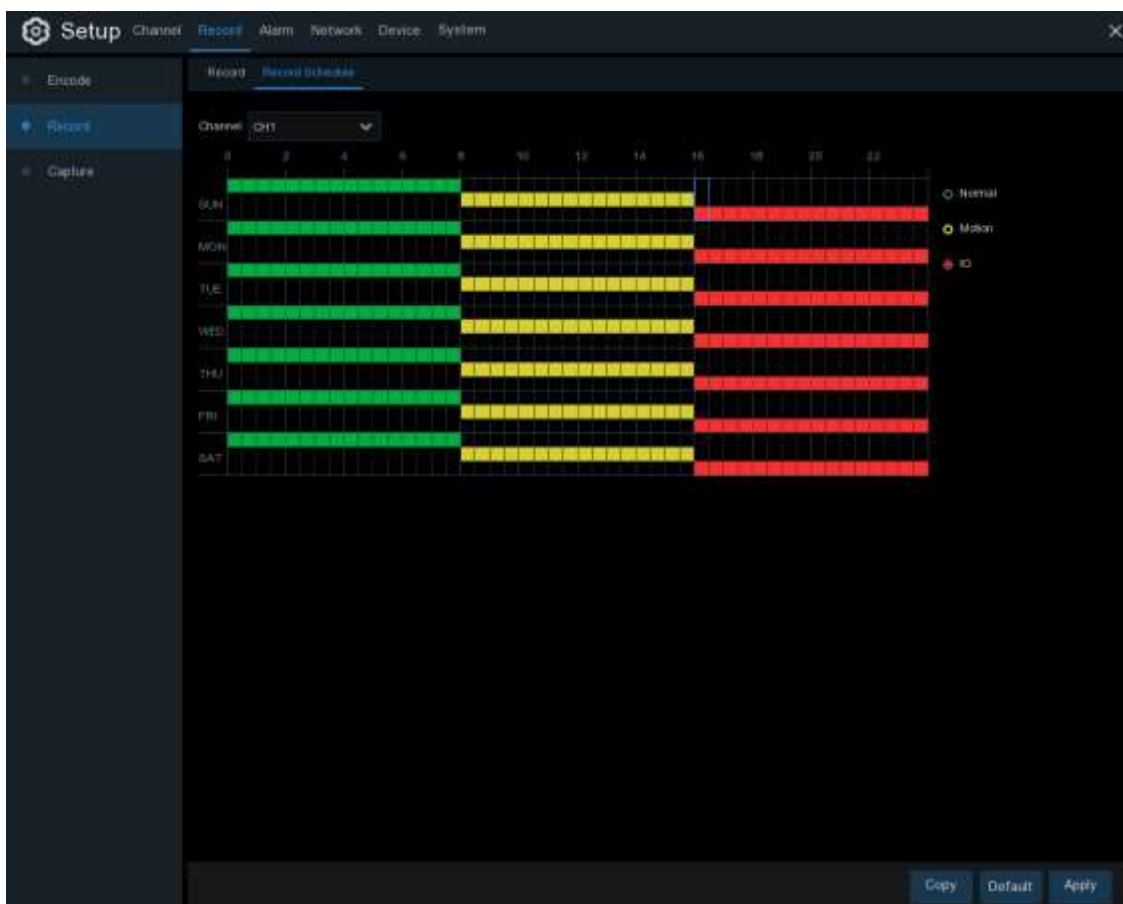

Channel: Select the channel to set its recording parameters.

Normal: When the time slot is marked green, this indicates the channel performs normal recording for that time slot.

Motion: When the time slot is marked yellow, this indicates the channel records only when a motion is detected during that time slot.

IO: When the time slot is marked red, this indicates the channel records only when the sensor is triggered during that time slot.

No Record: A time slot marked black means that there is no recording scheduled for the time slot.

5.2.3 Capture

This menu allows to configure the image capture function.

5.2.3.1 Capture

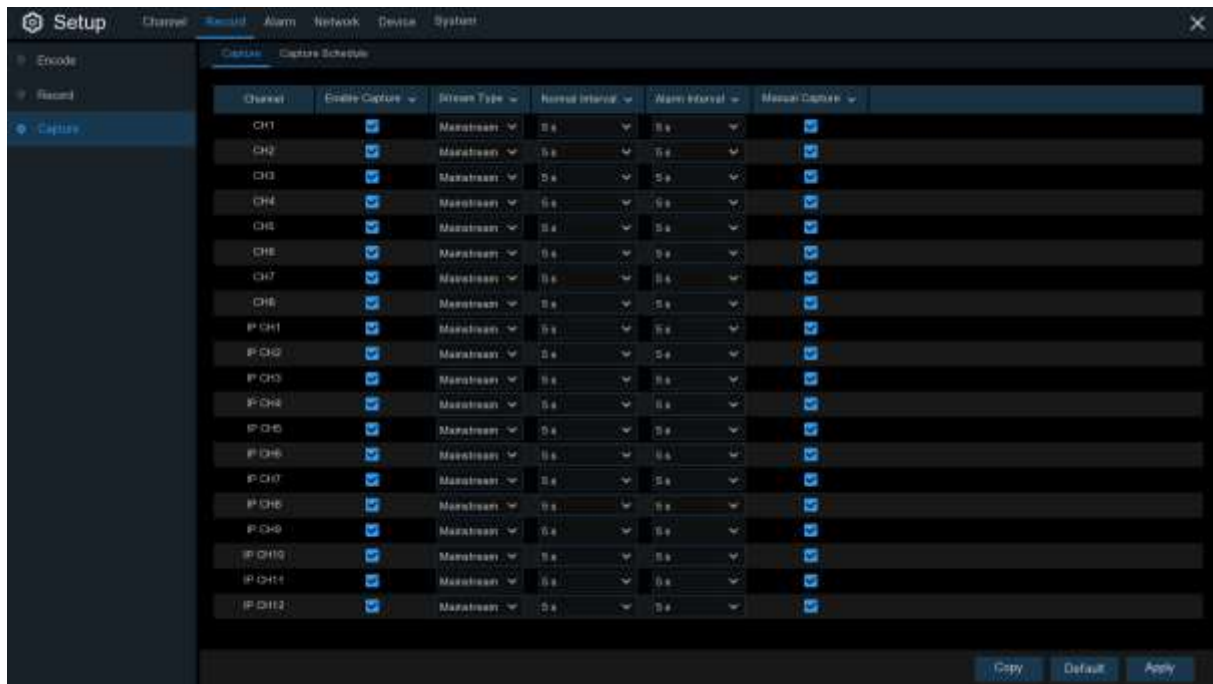

Enable Capture: Enable or disable automatic capturing on the channel.

Stream Type: Select the image resolution by mainstream or substream.

Normal Interval: Time interval to capture an image in normal recording.

Alarm Interval: Time interval to capture an image when motion, IO alarm or PIR is triggered

Manual Capture: Enable or disable manual capture in the channel

5.2.3.2 Capture Schedule

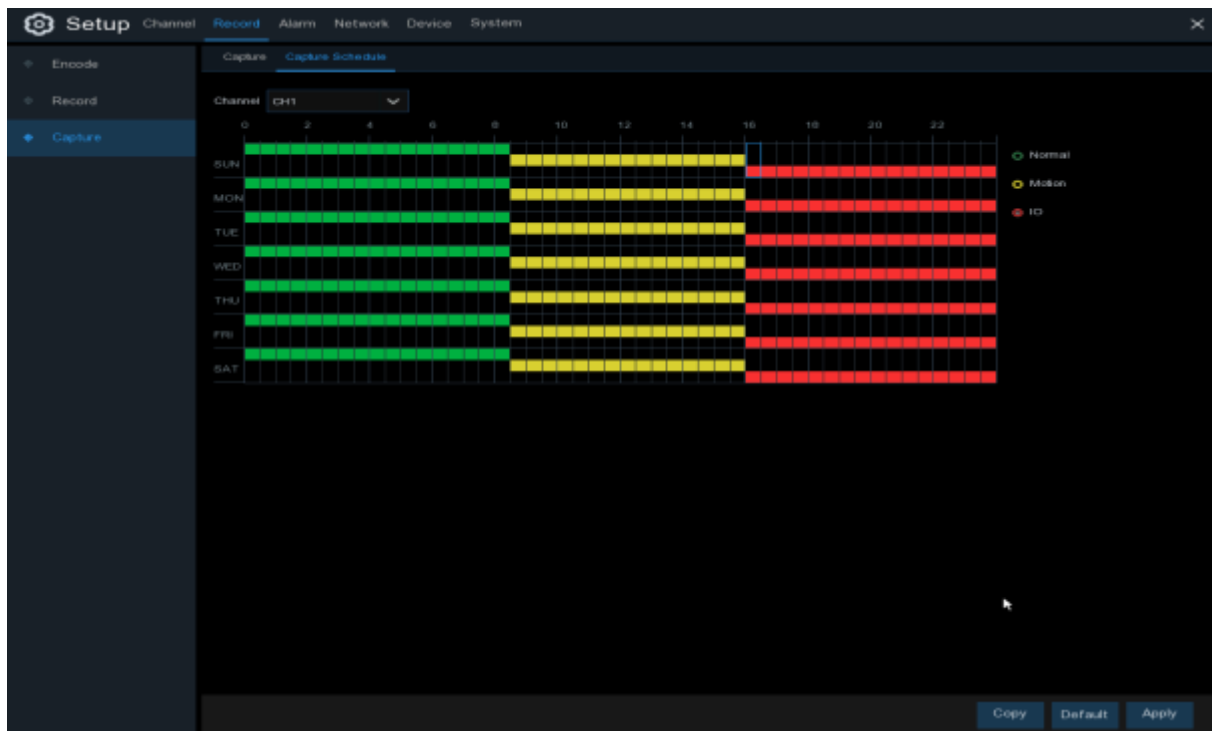

Channel: Select the channel to set its capture parameters.

Normal: When the time slot is marked green, this indicates the channel performs normal capture for that time slot.

Motion: When the time slot is marked yellow, this indicates the channel capture images only when a motion is detected during that time slot.

IO: When the time slot is marked red, this indicates the channel capture images only when the sensor is triggered during that time slot.

No Capture: A time slot marked black means that it won't capture any images for the time slot, but you can manually capture images if you enable the manual capture function in the channel.

5.3 Alarm

In this section, you can configure the alarm parameters.

5.3.1 Motion

Click **Alarm** button to configure the motion detection alarm function:

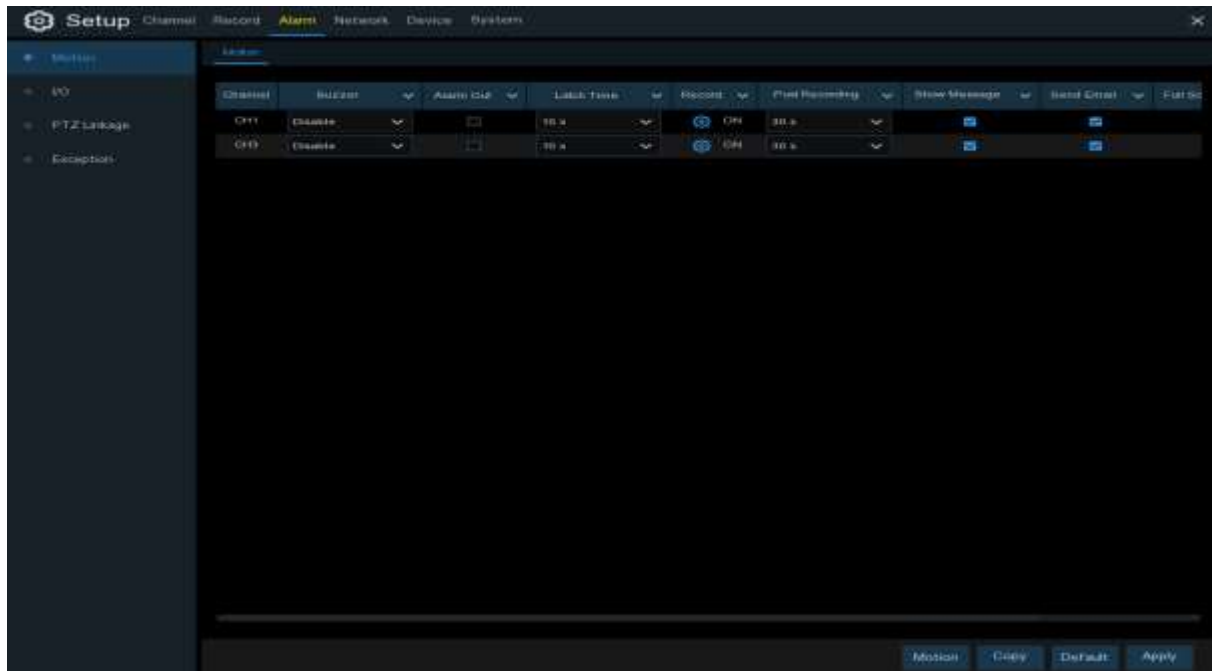

Channel: Channel name

Buzzer: The NVR can use its internal buzzer to emit an alarm tone. You can set the buzzer duration in seconds when the motion is detected.

Alarm Out: Optional function. If your NVR support to connect to external alarm device, you can set to emit an alarm tone.

Latch Time: To configure the external alarm time when motion is detected.

Record: Click  icon and choose which channel you want to record when the motion detection is triggered.

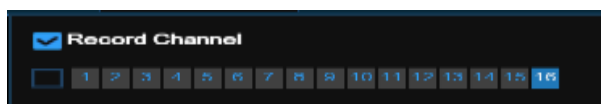

Post Recording: You can set how long after an event occurs that the NVR will continue to record. The recommended recording length is 30 seconds but it can be set higher up to 5 minutes.

Show Message: Check the box to display  icon on the live view screen when the motion is detected.

Send Email: You can let the NVR to send you an auto-email when the motion is detected.

Full Screen: If this function is enabled and a motion is detected in a channel, you will see that channel in full screen.

FTP Upload: To upload alarm images to FTP server when motion is detected. To enable FTP, see [5.4.4 FTP](#) for details.

5.3.2 I/O

This is an optional function, it will appear if your NVR supports sensor I/O, you connect external sensor I/O alarm devices to work with the NVR.

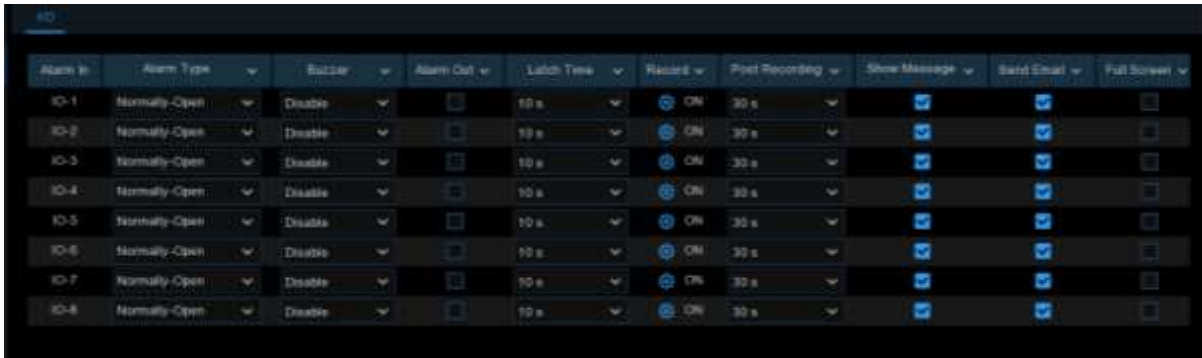

Alarm ID	Alarm Type	Buzzer	Alarm Out	Latch Time	Record	Post Recording	Show Message	Send Email	Full Screen
ID-1	Normally-Open	Disable	<input type="checkbox"/>	10 s	<input checked="" type="checkbox"/> ON	30 s	<input checked="" type="checkbox"/>	<input checked="" type="checkbox"/>	<input type="checkbox"/>
ID-2	Normally-Open	Disable	<input type="checkbox"/>	10 s	<input checked="" type="checkbox"/> ON	30 s	<input checked="" type="checkbox"/>	<input checked="" type="checkbox"/>	<input type="checkbox"/>
ID-3	Normally-Open	Disable	<input type="checkbox"/>	10 s	<input checked="" type="checkbox"/> ON	30 s	<input checked="" type="checkbox"/>	<input checked="" type="checkbox"/>	<input type="checkbox"/>
ID-4	Normally-Open	Disable	<input type="checkbox"/>	10 s	<input checked="" type="checkbox"/> ON	30 s	<input checked="" type="checkbox"/>	<input checked="" type="checkbox"/>	<input type="checkbox"/>
ID-5	Normally-Open	Disable	<input type="checkbox"/>	10 s	<input checked="" type="checkbox"/> ON	30 s	<input checked="" type="checkbox"/>	<input checked="" type="checkbox"/>	<input type="checkbox"/>
ID-6	Normally-Open	Disable	<input type="checkbox"/>	10 s	<input checked="" type="checkbox"/> ON	30 s	<input checked="" type="checkbox"/>	<input checked="" type="checkbox"/>	<input type="checkbox"/>
ID-7	Normally-Open	Disable	<input type="checkbox"/>	10 s	<input checked="" type="checkbox"/> ON	30 s	<input checked="" type="checkbox"/>	<input checked="" type="checkbox"/>	<input type="checkbox"/>
ID-8	Normally-Open	Disable	<input type="checkbox"/>	10 s	<input checked="" type="checkbox"/> ON	30 s	<input checked="" type="checkbox"/>	<input checked="" type="checkbox"/>	<input type="checkbox"/>

Alarm In: I/O channel.

Alarm Type: There are 3 types for your choice: Normally-Open, Normally-Close, and OFF. Choose the one to match your sensor type, or choose OFF to close the sensor trigger function.

Buzzer: The NVR can use its internal buzzer to emit an alarm tone. You can set the buzzer duration in seconds when a sensor is triggered.

Alarm out: Tick to enable external alarm device to emit an alarm tone when a sensor is triggered.

Latch Time: you can set how long the buzzer will sound when external sensor is triggered (10s, 20s, 40s, and 60s).

Record: Click  icon and choose which channel(s) you want to record when the motion detection is triggered.

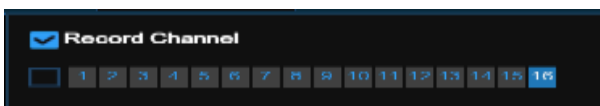

Post Recording: You can set how long alarm record will last when alarm ends (30s, 1 minute, 2 minutes, 5 minutes).

Show Message: Display the alarm messages on the screen when sensor is triggered.

Send Email: Set to send email to specified email when sensor is triggered.

Full Screen: When sensor is triggered, the corresponding channel will be switched to the full screen mode.

FTP Upload: To upload alarm images to FTP server when I/O alarm is triggered. To enable FTP, see [5.4.4 FTP](#) for details.

5.3.3 Intelligent

You can configure the SOD (Stationary Object Detection) / Sound Detection alarm functions here for UA-SNVR3240-N.

Channel: Channel name

Buzzer: The NVR can use its internal buzzer to emit an alarm tone. You can set the buzzer duration in seconds when an alarm is triggered.

Alarm Out: Optional function. If your NVR support to connect to external alarm device, you can set to emit an alarm tone.

Latch Time: To configure the external alarm time when an alarm is triggered.

Enable Record: Click  icon and choose which channel(s) you want to record when an alarm is triggered.



Post Recording: You can set how long after an event occurs that the NVR will continue to record. The recommended recording length is 30 seconds but it can be set higher up to 5 minutes.

Show Message: Check the box to display “S” icon on the live view screen when an alarm is triggered.

Send Email: You can let the NVR to send you an auto-email when an alarm is triggered.

FTP Picture Upload: To upload alarm images to FTP server when an alarm is triggered. To enable FTP, please view [5.5.4 FTP](#).

FTP Video Upload: To upload alarm video to FTP server when an alarm is triggered. To enable FTP, please view [5.5.4 FTP](#).

Picture to Cloud: To upload alarm images to Cloud server when an alarm is triggered. To enable Cloud, please view [5.6.2 Cloud](#).

Video to Cloud: To upload alarm video to Cloud server when an alarm is triggered. To enable Cloud, please view [5.6.2 Cloud](#).

Full Screen: If this function is enabled and an alarm is triggered in a channel, you will see its full screen images in live view.

5.3.4 Combination Alarm

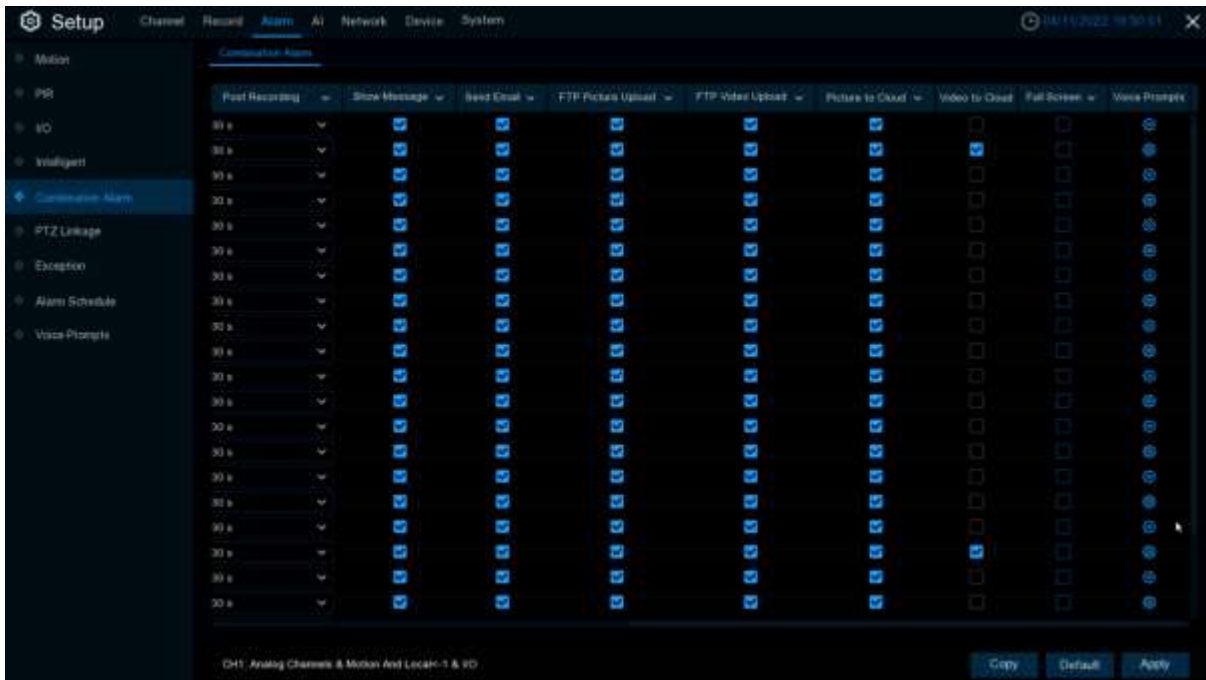

Channel: Channel name

Enable Alarm: Enable enables combination alarm (combination alarm system parameter of the channel configuration takes effect, alarm parameter set separately by the channel is not effective).

Disable does not enable combination alarm (combination alarm system parameter configured by the channel is not effective, and event alarm system parameter set separately by the channel does take effect).

Channel combination alarm is enabled. **Combination Configure** selects two alarm types. When both alarms are triggered within the same time period, the notification information such as buzzer, mail, push, upload is enabled. When only one of the alarms is triggered or when it is not triggered or when alarms other than the combination occurs, email, push and other notifications will not be sent. Two alarm types can be combined casually.

Buzzer: The DVR can use its internal buzzer to sound an alarm. You can set the buzzer duration (in seconds) when triggering a combined alarm.

Alarm out: Check whether the external alarm device is triggered when the combination alarm is triggered.

Latch Time: You can set the duration of triggering the external alert devices (10s, 20s, 40s, and 1Min).

Record: Click icon and select the channel to record when triggering the combination alarm.



Post Recording: You can set the duration of continuous DVR recording after the event occurs. The suggested recording time is 30 seconds, but can be set to up to 5 minutes.

Show Message: Select this box to display the corresponding alert icon on the real-time display screen when a combined alarm is detected.

Send Email: Set to send email to specified email when sensor is triggered.

FTP Picture Upload: To upload alarm images to FTP server when I/O alarm is triggered. To enable FTP, please view [5.5.4 FTP](#).

FTP Video Upload: To upload alarm videos to FTP server when **Combination alarm** is triggered. To enable FTP, please view [5.5.4 FTP](#).

Picture to Cloud: To upload alarm images to cloud storage when **Combination alarm** is triggered. Please view [5.6.2 Cloud](#).

Video to Cloud: To upload alarm videos to cloud storage when **Combination alarm** is triggered. Please view [5.6.2 Cloud](#).

Full Screen: When **Combination alarm** is triggered, the corresponding channel will be switched to the full screen mode.

Voice Prompts: Voice prompts, when triggering **Combination alarm**, the audio file imported by the voice prompt (requiring IPC to support the voice prompt function) can be visible for details [5.3.7 Voice Prompts](#).

Note: The Combination Alarm function is only applicable to UA-SNVRL810-P / SNVR1620-P V1.10 or later, and UA-SNVR3240-N.

5.3.5 PTZ Linkage

If you had connected the PTZ cameras, you can set the linkage between PTZ cameras and Motion Alarm and/or external I/O sensor alarm. With the linkage function, you can turn your PTZ cameras focus to the preset point when a motion or I/O alarm happens.

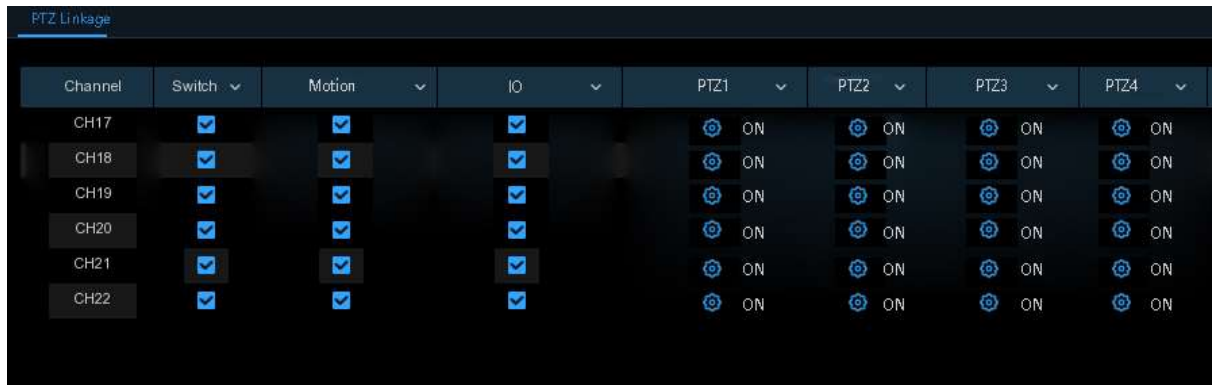

Channel	Switch	Motion	IO	PTZ1	PTZ2	PTZ3	PTZ4
CH17	<input checked="" type="checkbox"/>	<input checked="" type="checkbox"/>	<input checked="" type="checkbox"/>	ON	ON	ON	ON
CH18	<input checked="" type="checkbox"/>	<input checked="" type="checkbox"/>	<input checked="" type="checkbox"/>	ON	ON	ON	ON
CH19	<input checked="" type="checkbox"/>	<input checked="" type="checkbox"/>	<input checked="" type="checkbox"/>	ON	ON	ON	ON
CH20	<input checked="" type="checkbox"/>	<input checked="" type="checkbox"/>	<input checked="" type="checkbox"/>	ON	ON	ON	ON
CH21	<input checked="" type="checkbox"/>	<input checked="" type="checkbox"/>	<input checked="" type="checkbox"/>	ON	ON	ON	ON
CH22	<input checked="" type="checkbox"/>	<input checked="" type="checkbox"/>	<input checked="" type="checkbox"/>	ON	ON	ON	ON

Switch: Enable or disable the PTZ linkage function.

Motion: Motion detection alarm will trigger the PTZ linkage function it is checked.

IO: IO alarm will trigger the PTZ linkage function it is checked.

PTZ: Click  icon to associate the PTZ cameras with preset points. View preset point at [5.1.4.1](#)

[PTZ control.](#)

5.3.6 Exception

This menu allows you to set the type of events that you want the NVR to inform you.

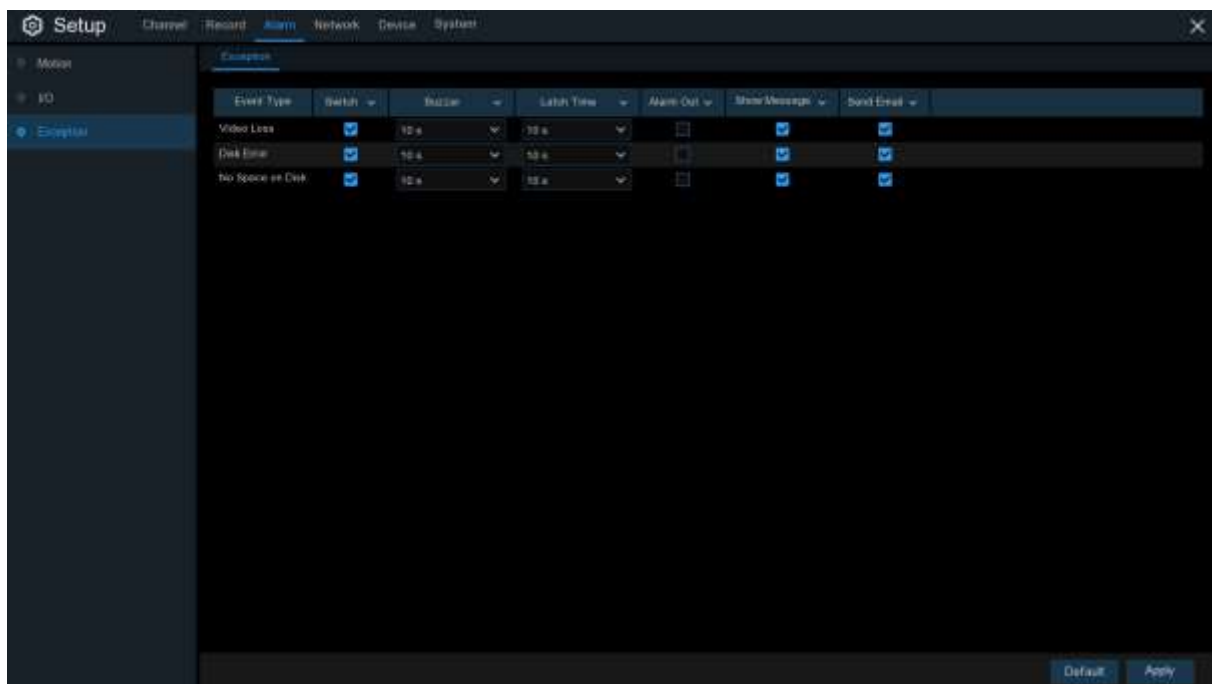

Event Type	Switch	Buzzer	Latch Time	Alarm Out	Show Message	Send Email
Video Loss	<input checked="" type="checkbox"/>	10 s	10 s	<input type="checkbox"/>	<input checked="" type="checkbox"/>	<input checked="" type="checkbox"/>
Disk Error	<input checked="" type="checkbox"/>	10 s	10 s	<input type="checkbox"/>	<input checked="" type="checkbox"/>	<input checked="" type="checkbox"/>
No Space on Disk	<input checked="" type="checkbox"/>	10 s	10 s	<input type="checkbox"/>	<input checked="" type="checkbox"/>	<input checked="" type="checkbox"/>

Event Type: Select the event type from below options:

- **No Space on Disk:** When an HDD is full.
- **Disk Error:** If the HDD is not detected properly.
- **Video Loss:** If a camera is not connected properly.

Switch: Check the box to enable the monitoring of the event.

Buzzer: Set the buzzer duration when the event occurs (Off/10s/20s/40s/60s). To disable buzzer, select **OFF**.

Latch Time: This is an optional function. Determine how long the external alarm device to sound (10s, 20s, 40s, 60s) if your NVR support to connect external alarm device.

Alarm Out: This is an optional function. Click to enable the external alarm device to sound. This is an optional function.

Show Message: Check the box to display a message on the screen when No Space on Disk, Disk Error, or Video Loss event happens.

Send Email: Let the NVR to send you an auto-email when an event occurs.

5.3.7 Voice Prompts

This function is to realize the alarm linkage when the alarm occurs. The system collects the alarm signal and the voice broadcast equipment, and automatically or manually plays the associated audio to the "intrusion" object on the scene.

Note: The Voice Prompts function is only applicable to UA-SNVRL810-P / SNVR1620-P V1.10 or later, and UA-SNVR3240-N.

5.3.7.1 File Management

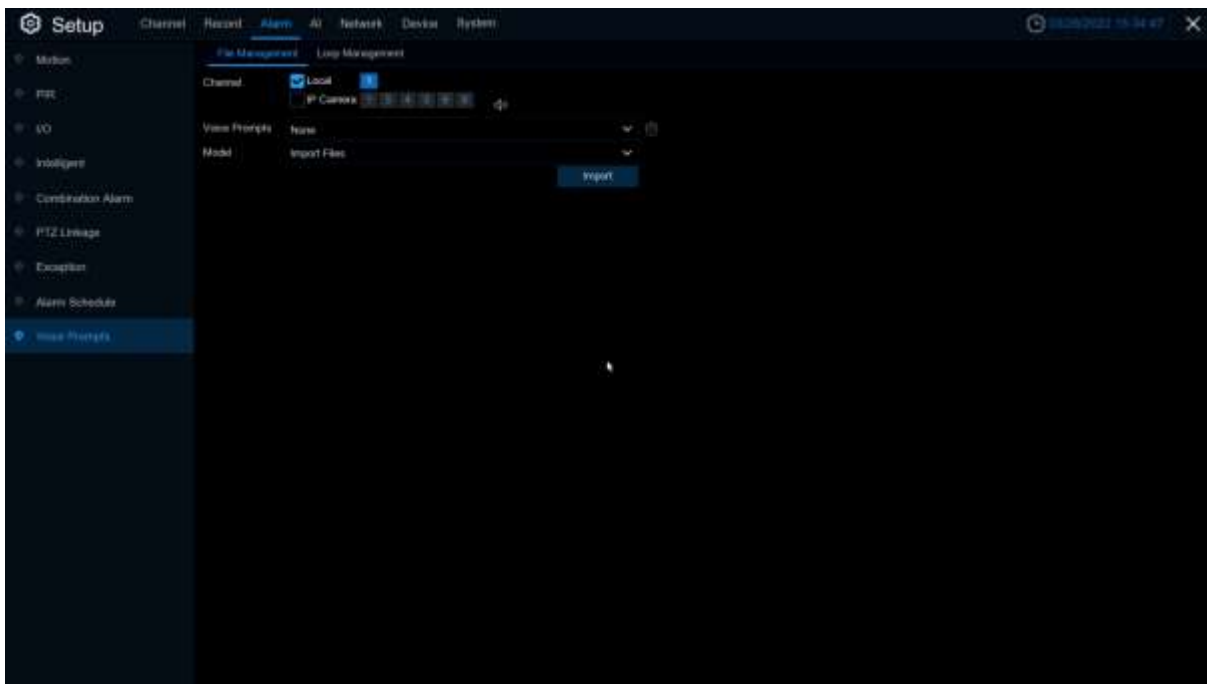

Click **Import** to import costumed audio. It supports three import modes: Import File, Local Conversion, and Internet Server Conversion.

Import File: Local import (support the import of audio files in MP3, WMA, WAV format)

Local Conversion: Local translation (input of text content to be translated, translated to audio file, and automatically saved to hard disk storage)

Internet Server Conversion: Web server translation (by locally entering the translated text content, sent to the network server for translation into audio files, and automatically saved to the local hard disk storage)

Local Conversion and **Internet Server Conversion** have more language box and text box than **Import File**. **Local Conversion** language selection is to English by default, and it doesn't choose any other language for the user.

The input box has a maximum allowed input length of 1,024 bytes. **Import File** import audio files, face database and license plate database allow file size of 1~500K, non-face database and license plate database allows file size of 1~5M.

After importing audio file, you can select which file to play in **Voice Prompt**.

Only Local is supported for the broadcast mode.

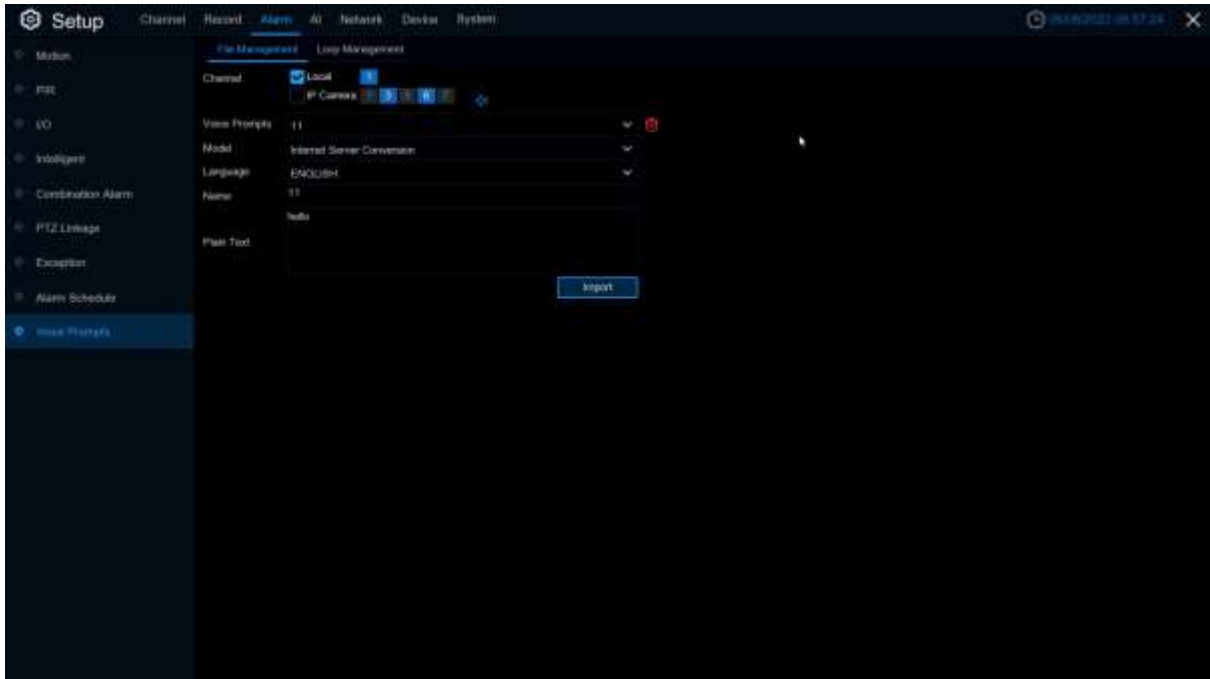

Local: Local broadcast (when choosing this broadcast mode, the audio output shall be connected to the device side)

Voice Prompts setting by time period: An alarm type can support setting the voice broadcast of up to 12 time periods. There is no conflict between the start and end time of any time period

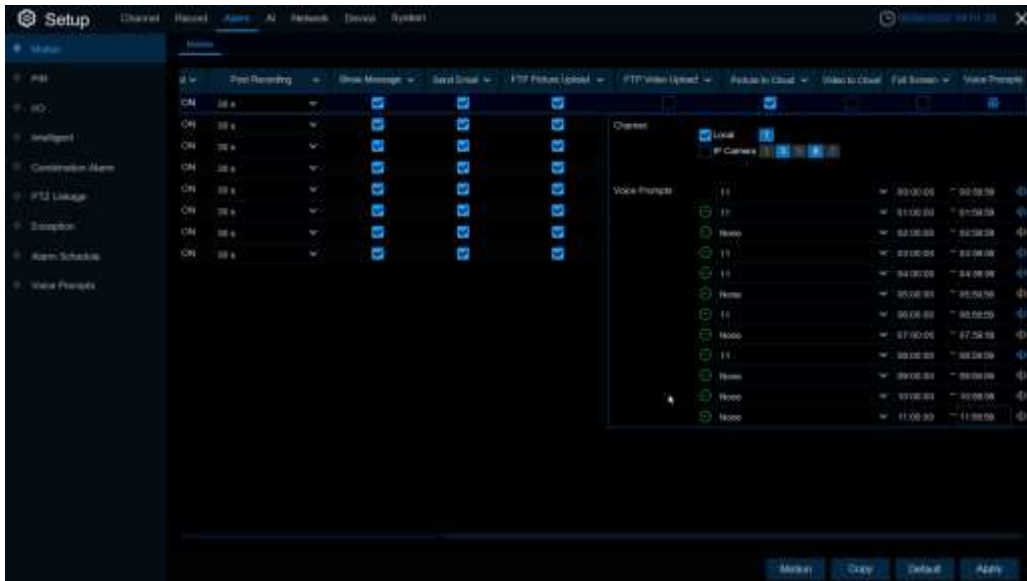

Voice broadcast setting based on face recognition: This function is to realize that when face recognition occurs, the system collects the alarm signal and the voice broadcast equipment for linkage, and automatically plays the associated audio to the scene "intrusion" object.

Note: Imported audio based on black and white list face images can only be used for the associated images.

When the face detection triggers the face detection, there will be a voice prompt.

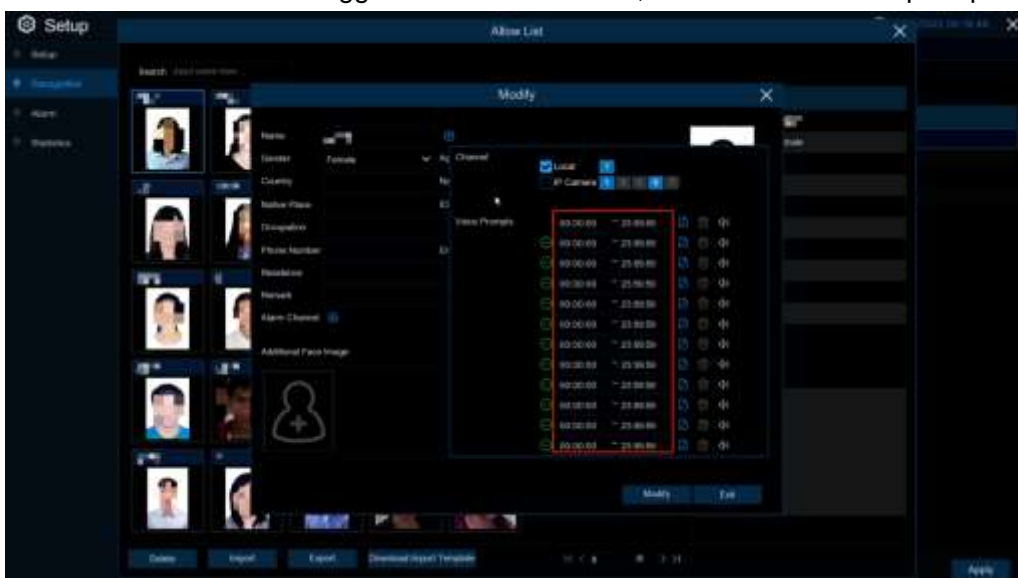

5.3.7.2 Loop Management

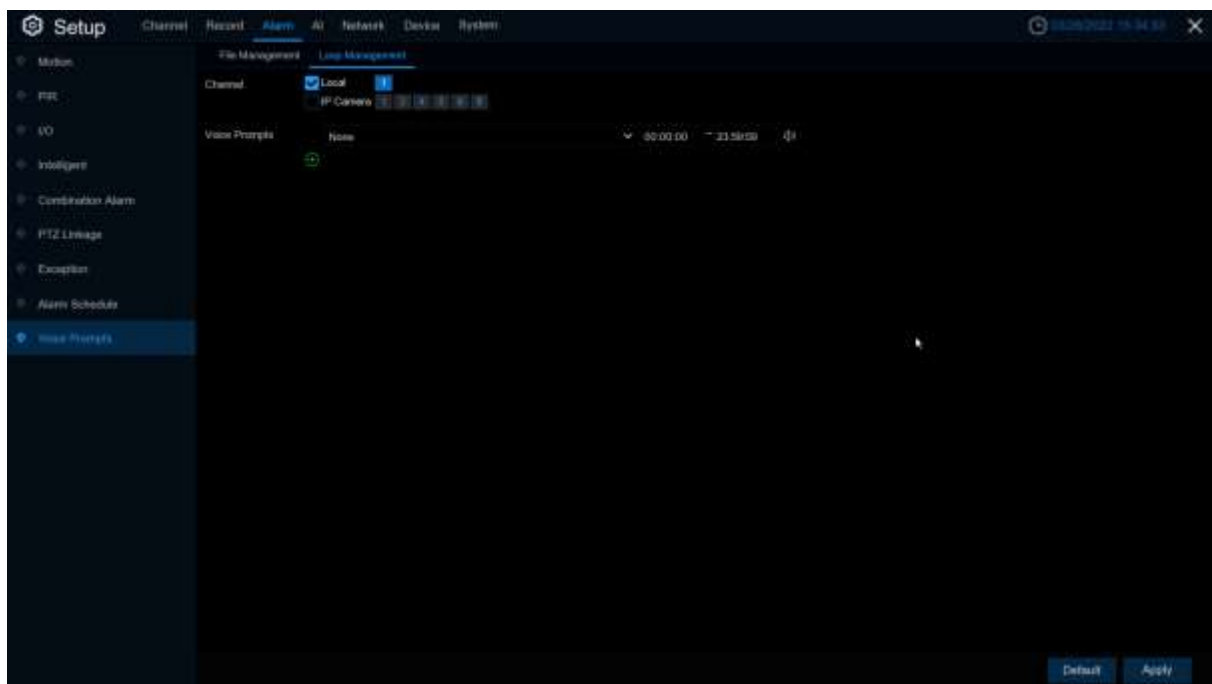

Voice Prompts selects the audio file, and after setting the time period, the selected audio file will be played repeatedly without alarm or hearing the audio file, supporting the voice broadcast for up to 12 time periods.

Local: Local broadcast (when choosing this broadcast mode, the audio output shall be connected to the device side)

5.4 AI

The AI functions include **FD (Face Detection)**, **PD & VD (Pedestrian and Vehicle Detection)**, **PID (Perimeter Intrusion Detection)**, **LCD (Line Crossing Detection)**, **CC (Cross Counting)**, **HM (Heat Map)**, **CD (Crowd Density Detection)**, **QD (Queue Length Detection)**, **LPD (License Plate Detection)**, and **RSD (Rare Sound Detection)**.

For UA-SNVR1620-P, you can also configure the functions of **SOD (Stationary Object Detection)** and **Sound Detection**.

Note:

1. The AI functions are only supported by the following AI-capable UA-IP cameras. Make sure to upgrade your camera to the latest firmware.
 - UA-B580F3
 - UA-R560F2
 - UA-R580F2
 - UA-R800F2
2. To properly connect to the IP cameras, make sure to the correct protocol (**Private**). See [4.1.4 IP Camera](#) for details.

5.4.1 Setup

5.4.1.1 FD (Face Detection)

Face Detection function detects the faces of moving people appear in a pre-defined region, and a series of actions can be taken when the alarm is triggered.

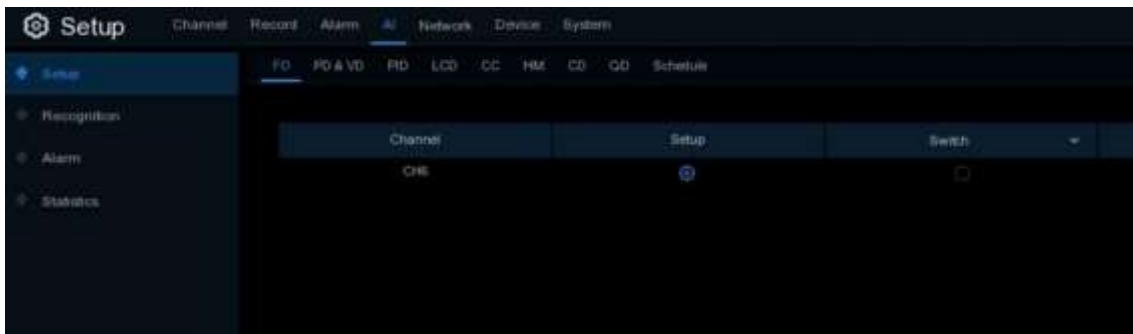

Switch: To enable or disable the face detection.

Click  to configure the face detection conditions.



Channel: Channel selection

Snap Mode: There are **“Optimal Mode”** (automatically select & push the best image from all face images of the same person whose faces were captured during his/her duration of stay), **“Realtime Mode”** (push the first captured face image and push again the last captured face image from the same person) and **“Interval Mode”** (customized the capture time and interval).

Apply Mode: Set the face detection angle, including “**Frontal View**”, “**Multi Angle**” and “**Customize**” mode.

If “**Customize**” mode is selected:

Roll Range: Set the range of face rotation under the customize mode.

Pitch Range: Set the range of face pitch under the customize mode

Yaw Range: Set the range of face horizontal flipping under the customize mode.

Min Pixel: Set the minimum detection pixel box. The face can be recognized only when it is larger than the pixel box.

Max Pixel: Set the maximum detection pixel box. The face can be recognized only when it is smaller than the pixel box.

Face Enhance: Face enhancement makes it easier to recognize the moving faces, but it may lower the whole picture quality.

Face Attribute: Enable this function to detect mask, glasses and facial expression.

Detection Mode: Motion Mode will detect moving faces. Static Mode will detect both moving faces and still faces.

Rule Kind: **Rect** (rectangular) and **Line** (linear)

If you choose **Rect** mode, you can choose “**Full Screen**” or “**Customize**” to adjust the shape of rectangular detection zone in the camera image. Faces appear in this zone will be detected and captured.

If you choose **Line** mode, you need to adjust the position, length of the line, and choose the detection direction from $B \rightarrow A$ or $A \rightarrow B$.

Dynamic Marking: If you enable this option, a capture box will be displayed upon the face image in both live view images and recording files.

5.4.1.2 PD & VD (Pedestrian and Vehicle Detection)

Pedestrian and Vehicle Detection function detects the moving people / vehicles in a pre-defined region, and a series of actions can be taken when the alarm is triggered.

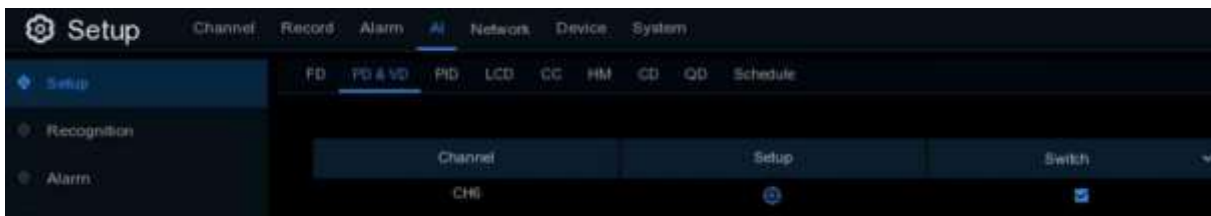

Switch: To enable or disable the Human & Vehicle detection.

Click to configure the detection conditions.

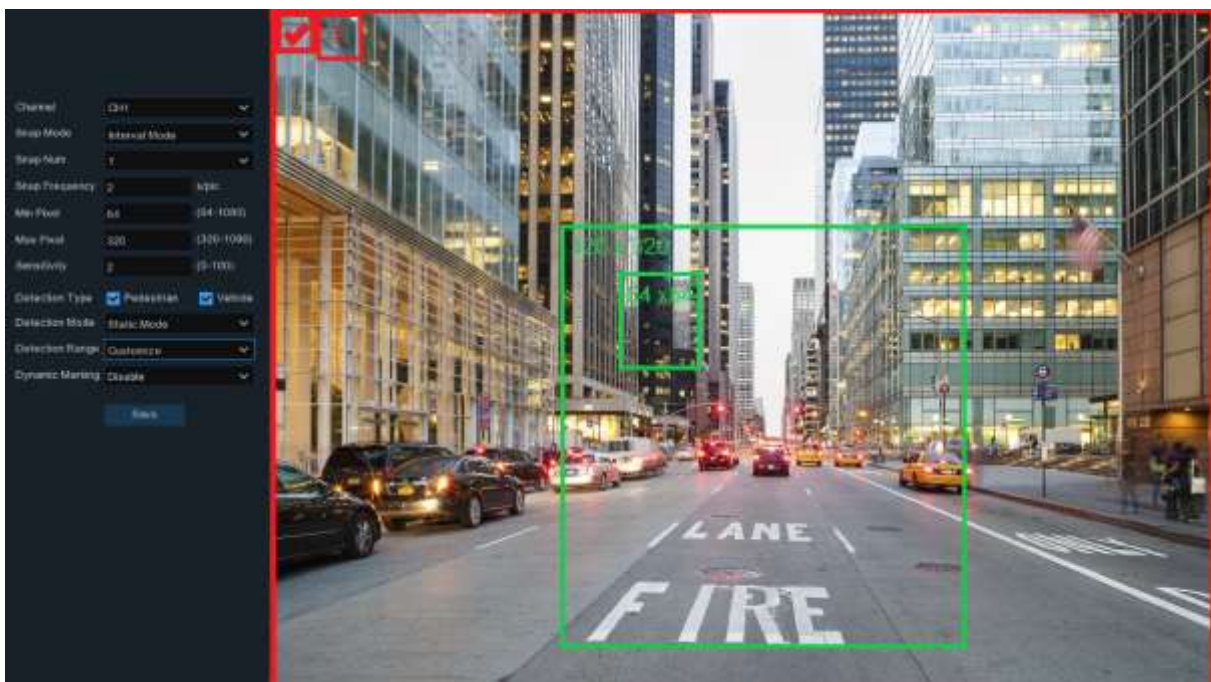

Channel: Channel selection

Snap Mode: There are “**Optimal Mode**” (automatically select & push the best image from all captured images of the same vehicle during its duration of stay), “**Realtime Mode**” (push the first captured image and push again the last captured image from the same vehicle) and “**Interval Mode**” (customized the capture time and interval).

Min Pixel: Set the minimum detection pixel box. The target objects can be recognized only when it is larger than the pixel box.

Max Pixel: Set the maximum detection pixel box. The target objects can be recognized only when it is smaller than the pixel box.

Sensitivity: Set the sensitivity level. Level 1 the lowest sensitivity level while level 100 is the highest sensitivity level.

Detection Type: Choose the detection target objects.

Detection Mode: Motion Mode will detect moving objects. Static Mode will detect both moving faces and still objects.

Detection Range: Set the detection zone. You can choose “**Full Screen**” or “**Customize**” to adjust the shape of rectangular detection zone in the camera image. Target objects appear in this zone will be detected and captured.

Dynamic Marking: If you enable this option, a capture box will be displayed upon the detected objects in both live view images and recording files.

5.4.1.3 PID (Perimeter Intrusion Detection)

Perimeter Intrusion Detection function detects people, vehicle or other objects which enter and loiter in a pre-defined virtual region, and some certain actions can be taken when the alarm is triggered.



Switch: To enable or disable the Perimeter Intrusion Detection.

Click  to configure the detection conditions.

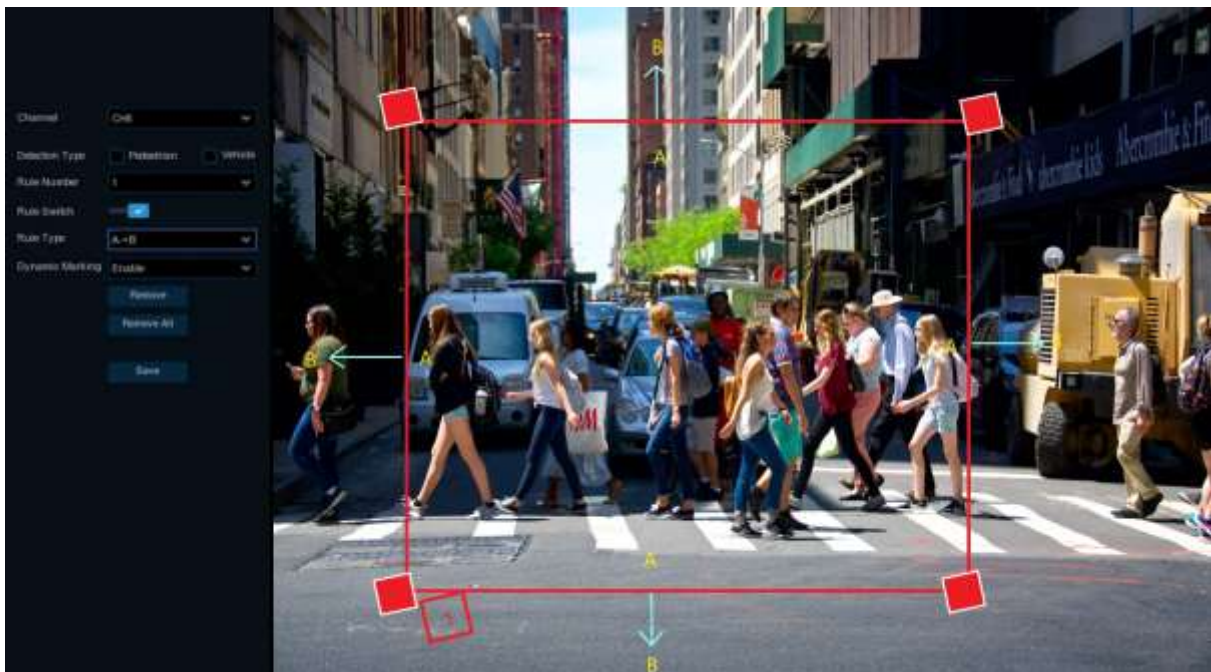

Channel: Channel selection

Detection Type: Choose the detection target objects.

Rule Number: Max. 4 rules available.

Rule Switch: Activate or inactivate the rule.

Rule Type: Detection direction from $B \rightarrow A$, $A \rightarrow B$ or $A \leftrightarrow B$

Dynamic Marking: If you enable this option, the border of the detection zone will be displayed in both live view images and recording files.

1. Choose one of the **Rule Number**. It is the number of LCD lines. Maximum 4 lines you can draw.
2. Choose the detection target type.
3. To enable the detection in **Rule Switch**.
4. Choose a **Rule Type**.
 - A→B: NVR will only detect the objects move from side A to side B;
 - B→A: NVR will only detect the objects move from side B to side A;
 - A↔B: NVR will detect the objects move from either side B to side A or side A to side B.
5. Use your mouse to click 4 points in the camera picture to draw a virtual region. The sharp of the region should be a convex polygon. Concave polygon will be not able to save.
6. Click **Save** to save your settings.
7. If you want to modify the position or sharp of region, click the red box in the region, the borders of the region will be changed to red color. Click and hold the left button of your mouse to move the position of the region, or drag the corners to resize the region.
8. If you want to remove one of the regions from the camera picture, click the red box in the region and then click **Remove** button. Click **Remove All** will delete all regions.

Notice:

- 1) The perimeter shall not be too close to the edges/corners of the camera picture, since it may fail to trigger the detection when the target pass through the edges/corners.
- 2) The shape of the regions shall not be too narrow/small, since it may fail to trigger the detection when the target passes through outside the perimeter.

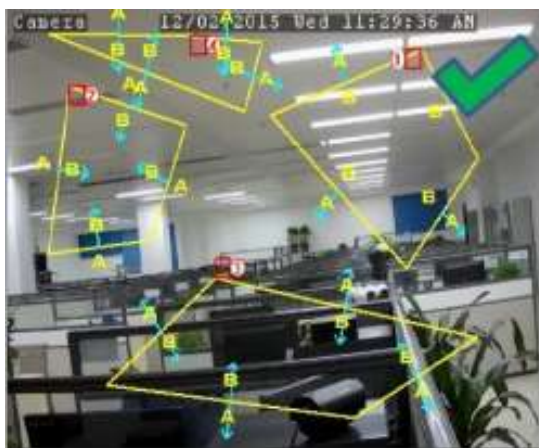

5.4.1.4 LCD (Line Crossing Detection)

Line Crossing Detection function detects people, vehicle or other objects which cross a pre-defined virtual line, and some certain actions can be taken when the alarm is triggered.



Switch: Check the box to enable the LCD function.

Sensitivity: Set the sensitivity level. Level 1 the lowest sensitivity level while level 4 is the highest sensitivity level.

Click **Setup** icon  to configure the detection conditions.



Channel: Select the channel you want to configure

Detection Type: Choose the detection target objects.

Rule Number: Max. 4 rules available.

Rule Switch: Activate or inactivate the rule

Dynamic Marking: If you enable this option, the border of the detection zone will be displayed in both live view images and recording files.

1. Choose one of the **Rule Number**. It is the number of LCD lines. Maximum 4 lines you can draw.
2. Choose the detection target type.
3. To enable the detection in **Rule Switch**.

4. Choose a **Rule Type**.
 - A→B: NVR will only detect the action from side A to side B;
 - B→A: NVR will only detect the action from side B to side A;
 - A↔B: NVR will detect the action from either side B to side A or side A to side B.
5. Use your mouse to click 2 points in the camera picture to draw a virtual line.
6. Click **Save** to save your settings.
7. If you want to modify the position or length of the line, click the red box in the line, the color of the line will be changed to red color. Click and hold the left button of your mouse to move the line, or drag the terminals to modify the length or position of the line.
8. If you want to remove one of the lines from the camera picture, click the red box in the line and then click **Remove** button. Click **Remove All** will delete all lines.

Notice:

- 1) The lines shall not be too close to the edges of the camera picture, to avoid any failure to trigger an alarm when the target cross through it.
- 2) The lines shall not be set too short, to avoid any failure to trigger an alarm when the target passes outside it.

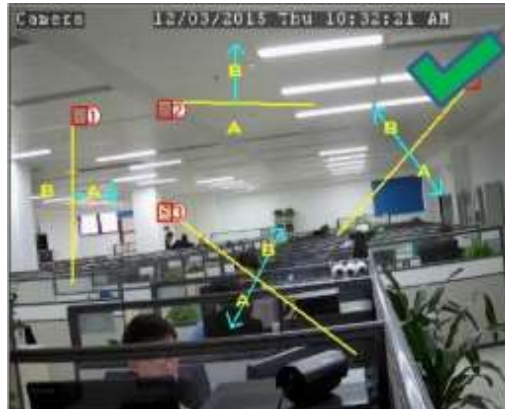

5.4.1.5 CC (Cross-Counting)

Cross-Counting function counts the times for moving objects or people across the virtual lines.



Switch: Check the box to enable the function.

Sensitivity: Set the sensitivity level. Level 1 the lowest sensitivity level while level 4 is the highest sensitivity level.

Click **Setup** icon to configure the detection conditions.



Channel: Select the channel you want to configure

Type: Choose the detection target objects. **Motion** will detect all moving objects, **Person** will detect human beings only, **Vehicle** will detect vehicles only.

Alarm Number: The NVR will send an alert if the number of entries minus the number of exits exceeds the alarm number. E.g., the number of entries is 601 while the number of exits is 400, and the alarm number you set is 200, $601-400 > 200$, then the NVR will send an alert.

Start Time: Set the detection start time.

End Time: Set the detection end time.

Reset Count: Clear the counting number.

Rule Number: Only 1 rule available.

Rule Switch: Activate or inactivate the rule.

1. Choose the detection target type.
2. Set the **Alarm Number**, **Start Time** and **End Time**.
3. To enable the detection in **Rule Switch**.
4. Choose a **Rule Type**.
 - A→B:** If a target object is detected moving from side A to side B, the system will count 1 to enter number; if a target object is detected moving from side B to side A, the system will count 1 to exit number.
 - B→A:** If a target object is detected moving from side B to side A, the system will count 1 to enter number; if a target object is detected moving from side A to side B, the system will count 1 to exit number.
5. Use your mouse to click 2 points in the camera picture to draw a virtual line.
6. Click **Save** to save your settings.
7. If you want to modify the position or length of the line, click the red box in the line, the color of the line will be changed to red color. Click and hold the left button of your mouse to move the line, or drag the terminals to modify the length or position of the line.
8. If you want to remove one of the lines from the camera picture, click the red box in the line and then click **Remove** button. Click **Remove All** will delete all lines.

Notice:

- 1) The lines shall not be too close to the edges of the camera picture, to avoid any failure to trigger an alarm when the target cross through it.
- 2) The lines should be in the area that detected object can be reach.
- 3) The lines shall not be set too short, to avoid any failure to trigger an alarm when the target passes outside it.



5.4.1.6 HM (Heat Map)

Automatically regular detect and count the movement of objects in the monitoring area. The frequency of people flows will be identified by different colors.



Switch: Check the box to enable LCD function.

Click **Setup** icon  to configure the detection conditions.

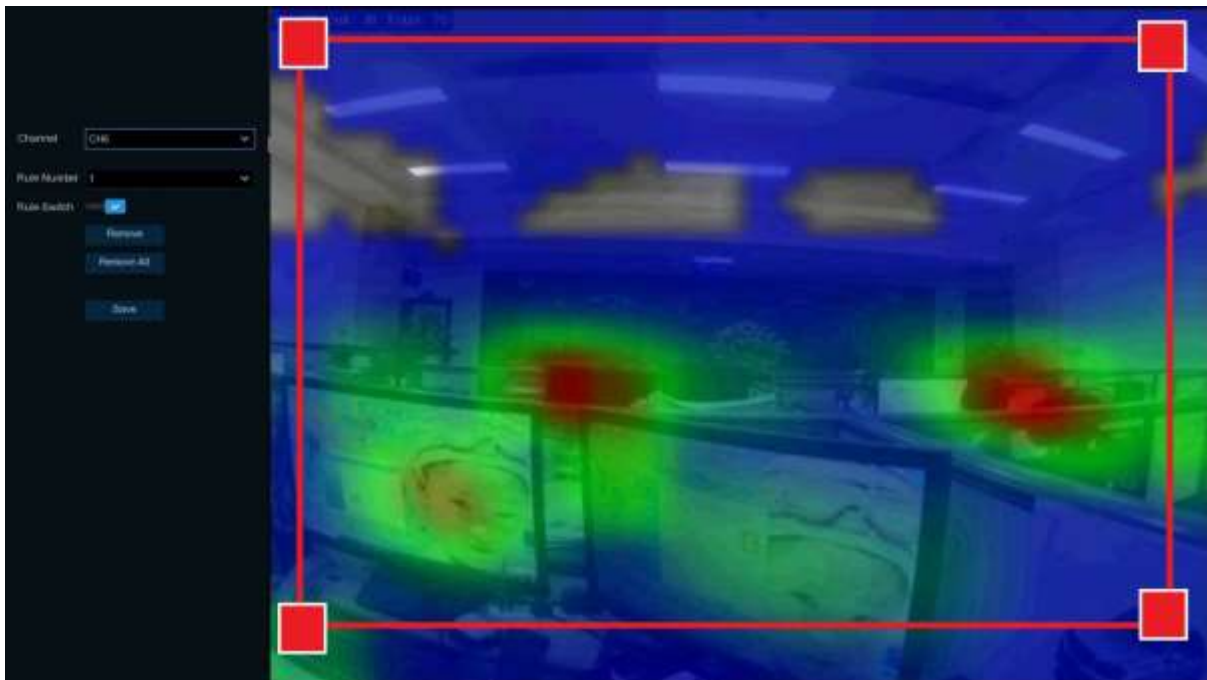

1. To enable the detection in **Rule Switch**.
2. Use your mouse to click 4 points in the camera picture to draw a virtual region. The sharp of the region should be a convex polygon. Concave polygon will be not able to save.
3. Click **Save** to save your settings.
4. If you want to modify the position or sharp of region, click the red box in the region, the borders of the region will be changed to red color. Click and hold the left button of your mouse to move the position of the region, or drag the corners to resize the region.
5. If you want to remove one of the regions from the camera picture, click the red box in the region and then click **Remove** button. Click **Remove All** will delete all regions.

5.4.1.7 CD (Crowd Density Detection)

Crowd density detection is used to detect crowd gathering to maintain a controllable order in certain area.



Switch: Check the box to enable the CD function.

Sensitivity: Set the sensitivity level. Level 1 the lowest sensitivity level while level 4 is the highest sensitivity level.

Click **Setup** icon to configure the detection conditions.



Min Pixel: Set the minimum detection pixel box. The people can be recognized only when he/she is larger than the pixel box.

Max Pixel: Set the maximum detection pixel box. The people can be recognized only when he/she is smaller than the pixel box.

Max Detection: The NVR will send an alert if the number of people inside the detection area exceeds the Max Detection number.

Dynamic Marking: If you enable this option, the border of the detection zone will be displayed in both live view images and recording files.

1. Set the min. pixel and max. pixel.
2. Set the limitation number in **Max. Detection**.
3. To enable the detection in **Rule Switch**.
4. Set the **Detection Range** to be full screen or customize.
5. If you choose customized detection range, you will need to use your mouse to click 8 points in the camera picture to draw a virtual region.
6. Click **Save** to save your settings.
7. If you want to modify the position or sharp of region, click the red box in the region, the borders of the region will be changed to red color. Click and hold the left button of your mouse to move the position of the region, or drag the corners to resize the region.
8. If you want to remove one of the regions from the camera picture, click the red box in the region and then click **Remove** button. Click **Remove All** will delete all regions.

5.4.1.8 QD (Queue Length Detection)

Queue length detection is used to detect the status of a queue, including its length and stagnation time.



Switch: Check the box to enable the QD function.

Sensitivity: Set the sensitivity level. Level 1 the lowest sensitivity level while level 4 is the highest sensitivity level.

Click **Setup** icon to configure the detection conditions.



Min Pixel: Set the minimum detection pixel box. The people can be recognized only when he/she is larger than the pixel box.

Max Pixel: Set the maximum detection pixel box. The people can be recognized only when he/she is smaller than the pixel box.

Max Detection: The NVR will send an alert if the number of crowds in the line inside the detection area exceeds the Max Detection number.

Max. Pro Time: The NVR will send an alert if the stagnation time of the queue is longer than the given processing time.

Dynamic Marking: If you enable this option, the border of the detection zone will be displayed in both live view images and recording files.

1. Set the min. pixel and max. pixel.
2. Set the limitation number in **Max. Detection**.
3. Set the limitation number in **Max. Pro Time**, the unit is second.
4. To enable the detection in **Rule Switch**.
5. Set the **Detection Range** to be full screen or customize.
6. If you choose customized detection range, you will need to use your mouse to click 8 points in the camera picture to draw a virtual region.
7. Click **Save** to save your settings.
8. If you want to modify the position or sharp of region, click the red box in the region, the borders of the region will be changed to red color. Click and hold the left button of your mouse to move the position of the region, or drag the corners to resize the region.
9. If you want to remove one of the regions from the camera picture, click the red box in the region and then click **Remove** button. Click **Remove All** will delete all regions.

5.4.1.9 LPD (License Plate Detection)

In this menu, you can set the relevant parameters of the license plate detection.

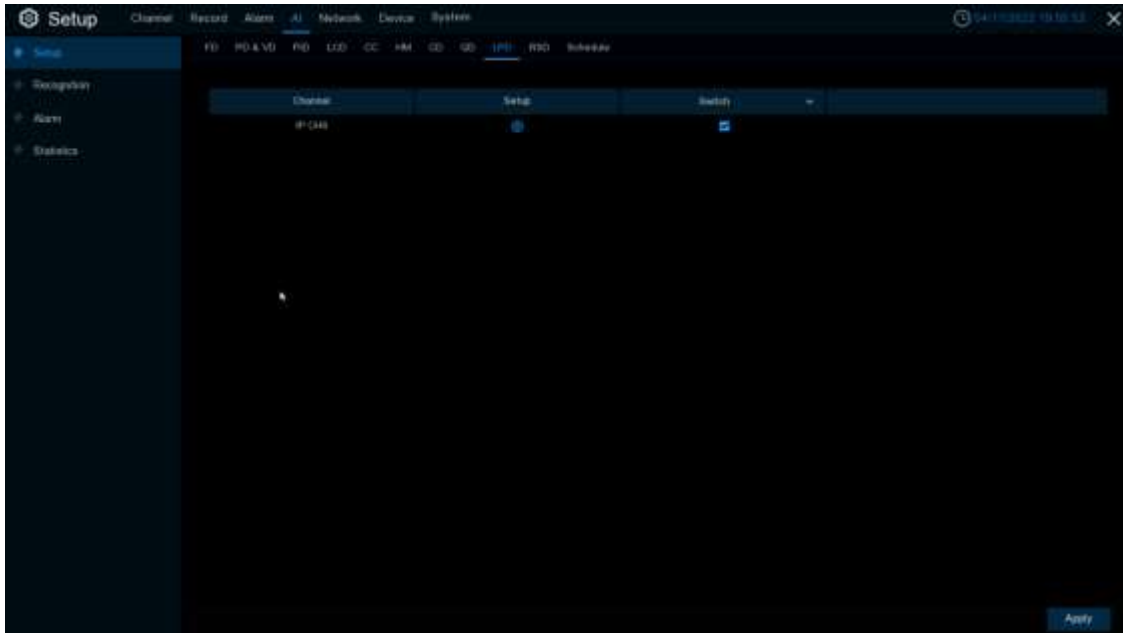

Setup: Click  to enter setup page.

Switch: Enable or disable LPD function.



Channel: Channel selection.

Snap Mode: There are “**Default Mode**” (push only one captured image with the best quality), “**Realtime Mode**” (push the first captured image and push again the last captured image from the same vehicle) and “**Interval Mode**” (customized the capture time and interval).

Min pixel: Minimum recognition pixel box, the license plate must be greater than the set minimum pixel to be recognized.

Max pixel: Maximum recognition pixel box, the license plate should be less than the set maximum pixel to be recognized.

Sensitivity: Sensitivity, the larger the value, the easier to detect the target.

Detection Mode: License plate detection mode, there are two modes.

Static Mode: Check the static license plate in the picture.

Motion Mode: Filter out the stationary vehicles and their license plates to detect only the vehicles in the dynamic process.

Detection Range: There are two areas for license plate detection as follows:

Full Screen: Full-screen detection,

Customize: Custom detection area.

Dynamic Marking: Tracking box.

5.4.1.10 RSD (Rare Sound Detection)

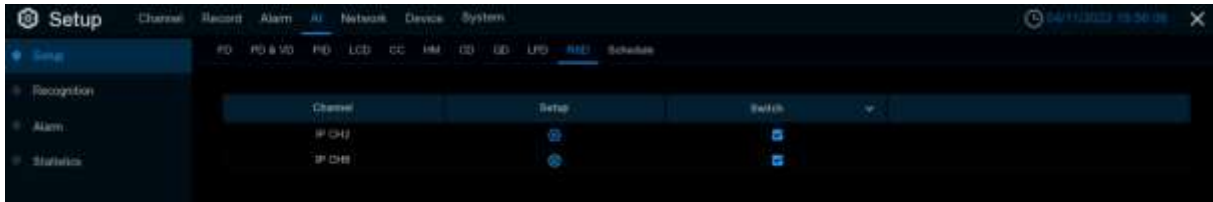

Setup: Click  to enter setup page.

Switch: Enable or disable RSD function.



Channel: Channel selection.

Sensitivity: Sensitivity, 1 is the minimum, 100 in the maximum.

Detection Type: Choose the detection type by clicking to enable detection for **Baby Crying Sound**, **Dog Barking**, or **Gunshot**.

5.4.1.11 SOD (Stationary Object Detection)

See 5.1.7.1 SOD (Stationary Object Detection) for details.

5.4.1.12 Sound Detection

See 5.1.7.2 Sound Detection for details.

5.4.1.13 Schedule



In order to active the AI function, you need to config the schedule. The schedule will be active in 24 hours x 7 days.

To set the schedule, choose one channel then click on one of the detection items on the right side, then drag the cursor to mark the slots. The schedule is valid only for the selected channel each time when you set. If you want to use the same schedule for other channels, use **Copy** function. Click **Save** to save your settings.

5.4.2 Face Recognition

To start face recognition, you need to configure the face recognition algorithm model and database.

Note:

1. The Face Recognition function is only applicable to **UA-SNVR1620-P** and **UA-SNVR3240-N** when connected to the following UA-IP cameras with specified firmware versions. Before configuring Face Recognition, make sure **Face Detection** is enabled on the connected camera.
 - UA-B580F3 (V1.01 or later)
 - UA-R560F2 (V1.01 or later)
 - UA-R580F2 (V1.01 or later)
 - UA-R800F2 (V1.01 or later)
2. To see AI applications for different scenarios using Face Recognition results, see [5.8.2 Face Attendance](#), [6.1.6.1 Face Search](#), [6.1.6.4 Repeat Visitors](#), and [6.1.6.5 Face Attendance](#).

5.4.2.1 Model Configuration



To choose the face algorithm model. Auto select recognition model is recommended. Face Recognition is enabled by default.

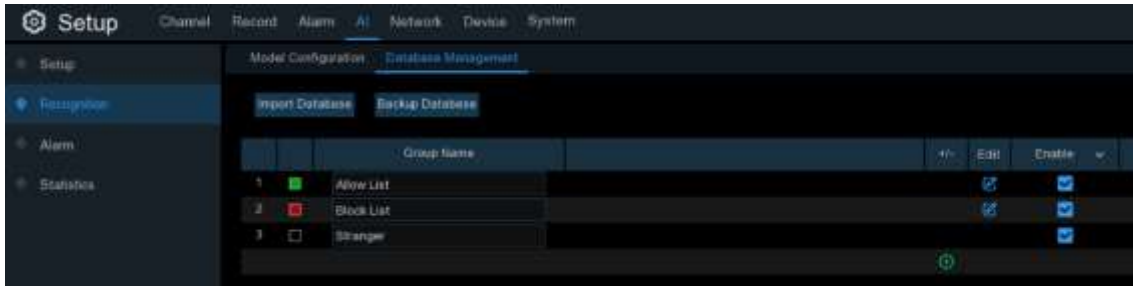

5.4.2.2 Database Management

You can create the face database to classify different faces.



There are 3 default groups: **Allow List**, **Block List**, and **Stranger**. You can use the add icon  and delete icon  to add or delete customized groups.

Import Database: Import database from USB memory / local HDD storage.

Backup Database: Export database to USB memory / local HDD storage.

Enable: Check to enable the group.

Edit: Click edit icon  to edit the group. This page appears.

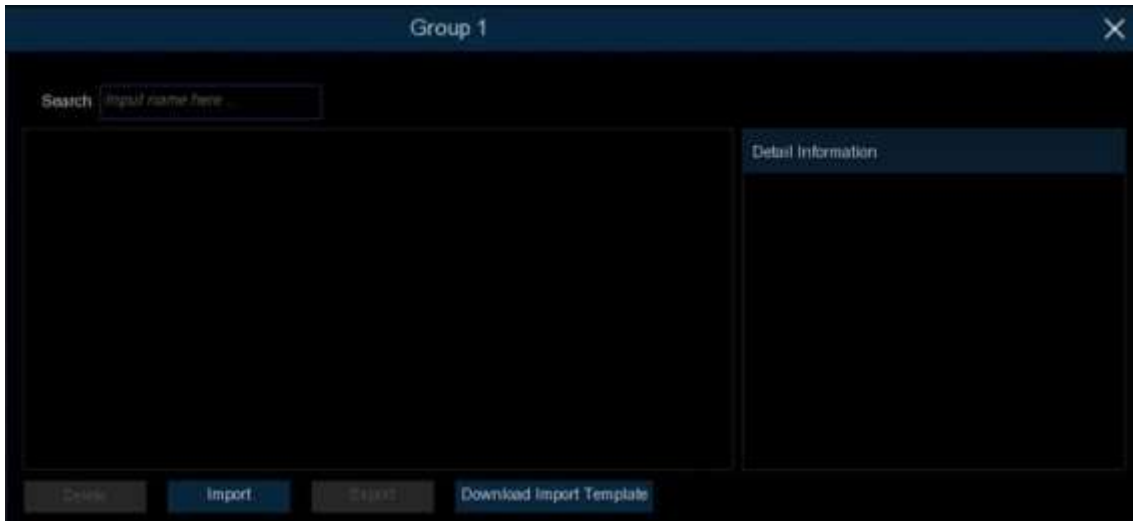

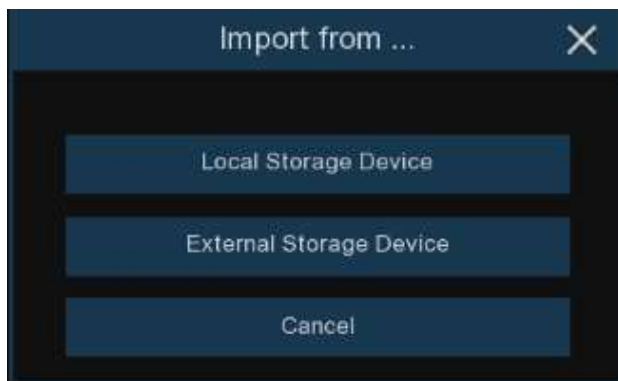

Import: Click the Import button to import face images. You're able to import files from NVR local HDD storage and/or external storage.

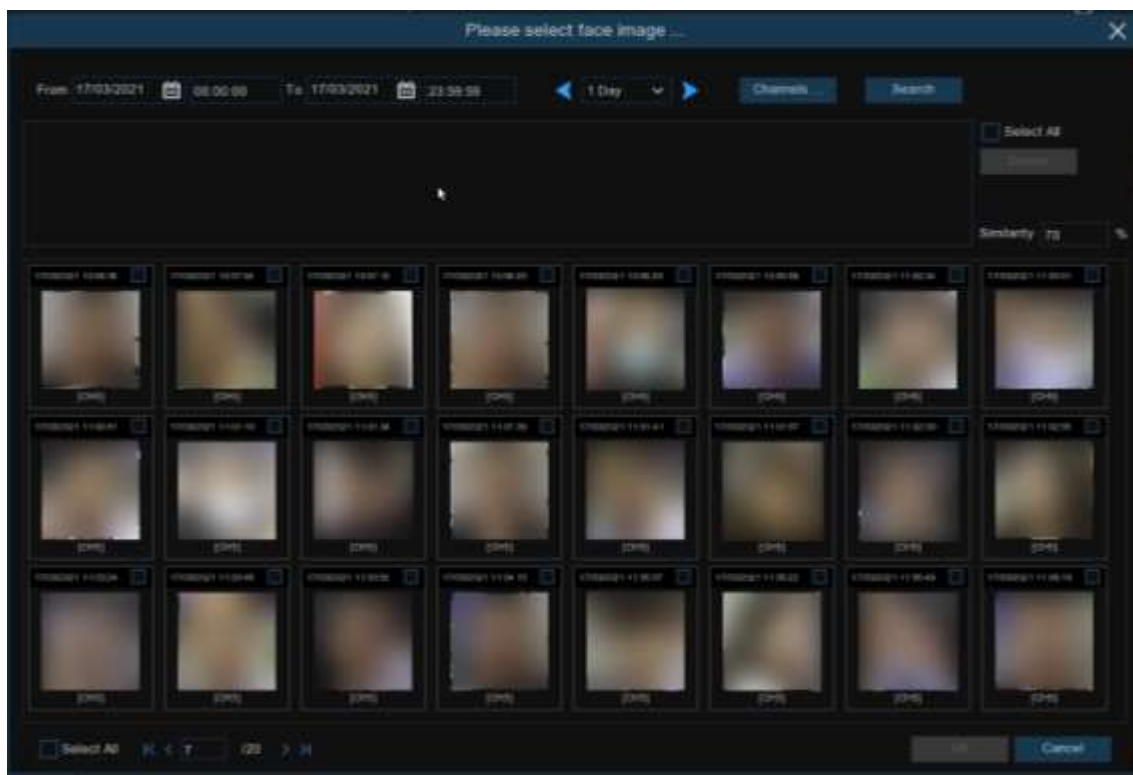

Click **Local Storage Device** to import face images which were captured and saved in the NVR local HDD storage.



1. Choose the start time and end time manually. Or you can select the time interval from 1 day, 2 days, 3 days, 4 days, 5 days, 6 days, 1 week and 1 month, and then click the  or  button to move to left or right period.
2. Choose the channels you want to search.
3. Click **Search** button.
4. The result will be displayed in the bottom window.
5. Check the box upon the face images you want to add, or click **Select All** to add all images.

6. If you want to narrow down the search result, you can choose one or multiple images in the bottom window as target face(s), and then set the **Similarity** value. Click **Search** again, the system will search and display the faces which are similar with your target face(s).
7. Click **OK** to add images. You can edit the personal information for the faces you want to import.
8. Click **Import** button to import the face images.

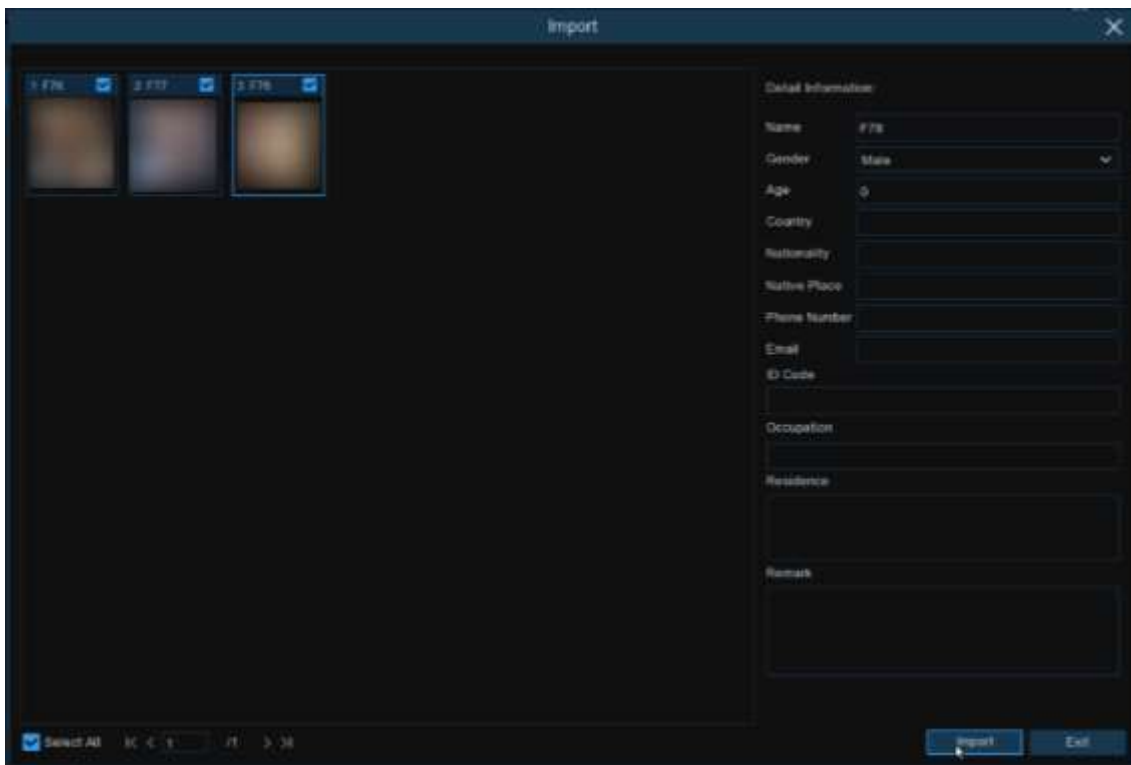

Use the same method to add face images from external USB storage devices.

5.4.3 Alarm

5.4.3.1 FR (Face Recognition)

To configure alarm actions for different face groups when faces detected.

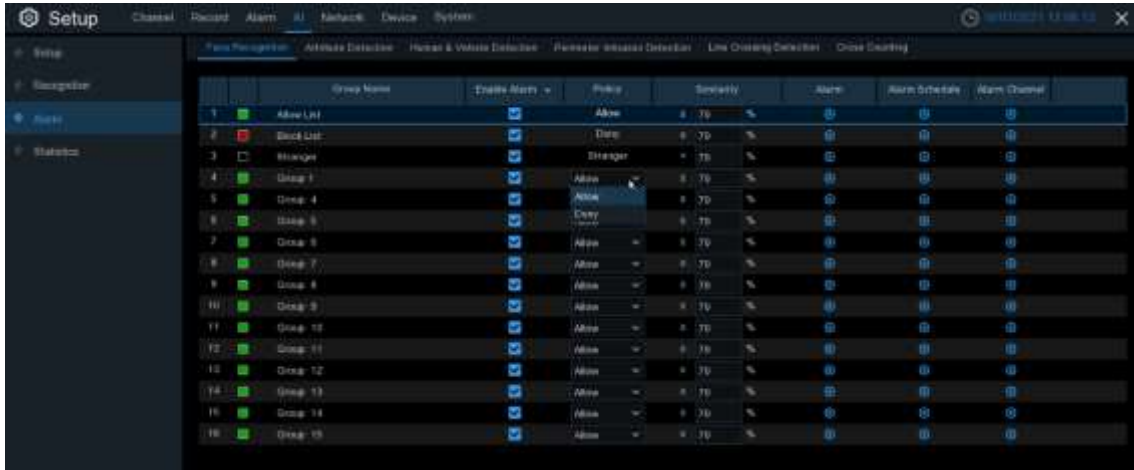

Enable Alarm: To enable or disable the alarm function.

Policy: To set the group to be **Allow** list or **Deny** list.

Similarity: Set the similarity of comparison.

Alarm Channel: To choose which channel(s) will be applied to the alarm setting.

Alarm: Click to configure the alarm actions.

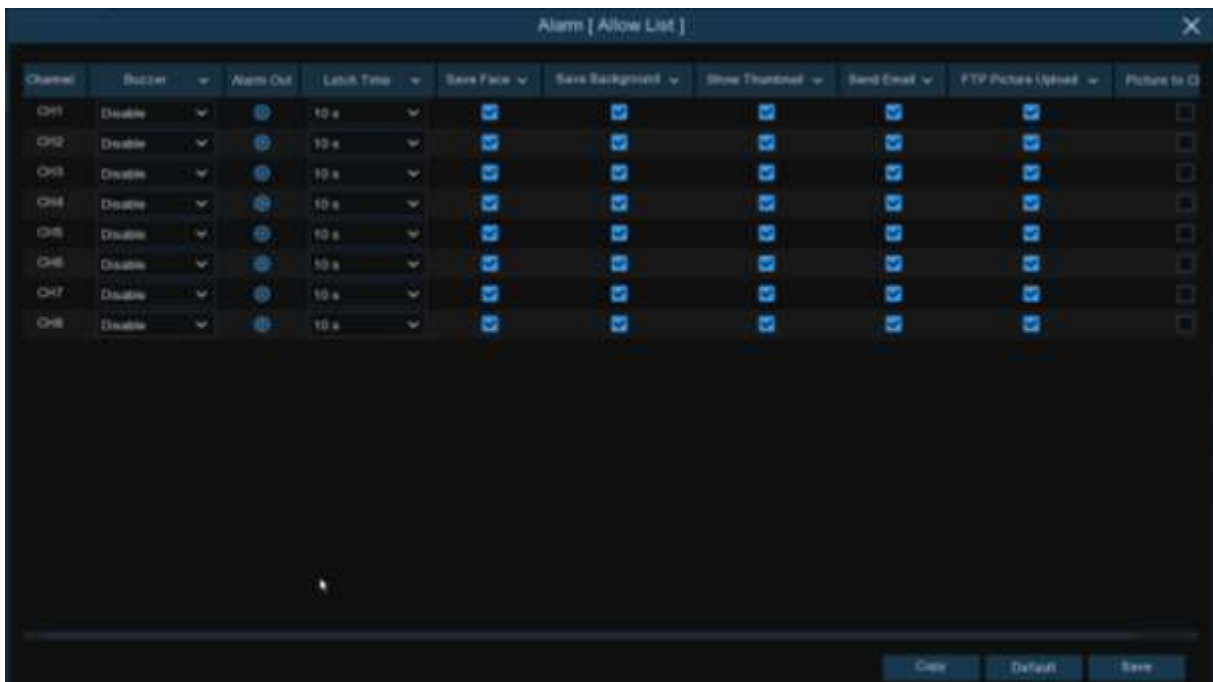

Buzzer: The NVR can use its internal buzzer to emit an alarm tone. You can set the buzzer duration in seconds when an alarm is triggered.

Alarm Out: Optional function. If your NVR support to connect to external alarm device, you can set to emit an alarm tone.

Latch Time: To configure the external alarm time when an alarm is triggered.

Face Capture: To save the captured face.

Save Background: To save the whole image when an alarm is triggered.

Show Thumbnail: To pop-up the thumbnail image in live view screen when an alarm is triggered.

Send Email: You can let the NVR to send you an auto-email when an alarm is triggered.

FTP Picture Upload: To upload alarm images to FTP server when an alarm is triggered. To enable FTP, please view [5.5.4 FTP](#).

Picture to Cloud: To upload alarm images to Cloud server when an alarm is triggered. To enable Cloud, please view [5.6.2 Cloud](#).

Alarm Schedule: Click  icon to configure the alarm schedule for each channel.



Channel: Select the channel to set its capture parameters.

To set the schedule, choose one channel then drag the cursor to mark the slots. The blue blocks in the time slots will be active for alarm. The schedule is valid only for the selected channel each time when you set. If you want to use the same schedule for other channels, use **Copy** function. Click **Save** to save your settings.

5.4.3.2 AD (Attribute Detection)

Attribute detection is a function to detect people's facial features and send an alarm according to the settings. This is applicable for **Face Detection** function.



Alarm Type: Select the alarm trigger condition. If the selection is **“No Mask”**, the NVR will send an alarm if it detects a person doesn't wear a face mask. If the selection is **“Wear Mask”**, the NVR will send an alarm if it detects a person wears a face mask.

Buzzer: The NVR can use its internal buzzer to emit an alarm tone. You can set the buzzer duration in seconds when an alarm is triggered.

Alarm Out: Optional function. If your NVR support to connect to external alarm device, you can set to emit an alarm tone.

Latch Time: To configure the external alarm time when an alarm is triggered.

Record: Click  icon and choose which channel(s) you want to record when the alarm is triggered.



Post Recording: You can set how long after an event occurs that the NVR will continue to record. The recommended recording length is 30 seconds but it can be set higher up to 5 minutes.

Show Message: Check the box to display **“S”** icon on the live view screen when the alarm is triggered.

Send Email: You can let the NVR to send you an auto-email when an alarm is triggered.

Full Screen: If this function is enabled and an alarm is triggered in a channel, you will see its full screen images in live view.

5.4.3.3 Other AI Alarms

To configure alarm actions for the following AI functions: **PD & VD (Pedestrian and Vehicle Detection)**, **PID (Perimeter Intrusion Detection)**, **LCD (Line Crossing Detection)**, **CC (Cross Counting)**, **HM (Heat Map)**, **CD (Crowd Density Detection)**, **QD (Queue Length Detection)**, **LPD (License Plate Detection)**, and **RSD (Rare Sound Detection)**.

For UA-SNVR1620-P, you can also configure the alarms for **SOD (Stationary Object Detection)** and **Sound Detection** here.

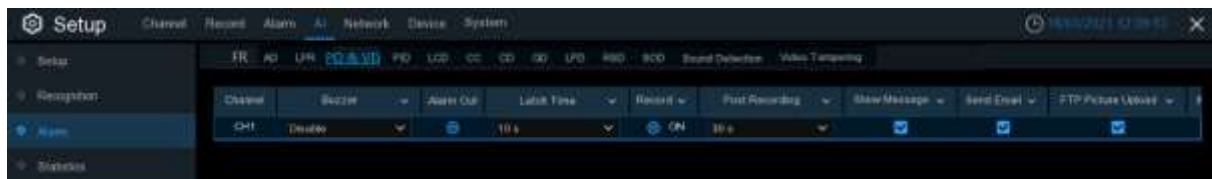

Buzzer: The NVR can use its internal buzzer to emit an alarm tone. You can set the buzzer duration in seconds when an alarm is triggered.

Alarm Out: Optional function. If your NVR support to connect to external alarm device, you can set to emit an alarm tone.

Latch Time: To configure the external alarm time when Human & Vehicle is detected.

Record: Click  icon and choose which channel(s) you want to record when the Human & Vehicle detection is triggered.



Post Recording: You can set how long after an event occurs that the NVR will continue to record. The recommended recording length is 30 seconds but it can be set higher up to 5 minutes.

Show Message: Check the box to display “S” icon on the live view screen when an alarm is triggered.

Send Email: You can let the NVR to send you an auto-email when an alarm is triggered.

FTP Picture Upload: To upload alarm images to FTP server when an alarm is triggered. To enable FTP, please view [5.5.4 FTP](#).

Picture to Cloud: To upload alarm images to Cloud server when an alarm is triggered. To enable Cloud, please view [5.6.2 Cloud](#).

Full Screen: If this function is enabled and an alarm is triggered in a channel, you will see that channel in full screen.



5.4.4 Statistics

You are able to check and manage the statistics of **FR (Face Recognition)**, **PD&VD (Pedestrian and Vehicle Detection)**, **CC (Cross Counting)**, and **HM (Heat Map)** in this section.

5.4.4.1 FR (Face Recognition)

You can check the face recognition statistics in a certain period.



1. Choose the group(s) and channel(s).
2. Select the period from day, week, month, quarter and year.
3. Click the calendar icon to choose the date, and click  or  button to move to last or next period.
4. The statistics will be displayed in pie chart and column chart.
5. Click **Export** button if you want to export the data to USB memory.

Note: See the following sections for the functions of **Face Search**, **Repeat Visitors**, and **Face Attendance**:

- [6.1.9.1 Face Search](#)
- [6.1.9.4 Repeat Visitors](#)
- [6.1.9.5 Face Attendance](#)

5.4.4.2 PD&VD (Pedestrian and Vehicle Detection)

You can check the face recognition statistics in a certain period.



1. Choose the detection type in **Intelligent / AI**.
2. Choose the channel(s).
3. Select the period from day, week, month, quarter and year.
4. Click the calendar icon to choose the date, and click **<** or **>** button to move to last or next period.
4. The statistics will be displayed in pie chart and column chart.
5. Click **Export** button if you want to export the data to USB memory.

5.4.4.3 CC (Cross-Counting)

You can check the cross counting statistics in a certain period.

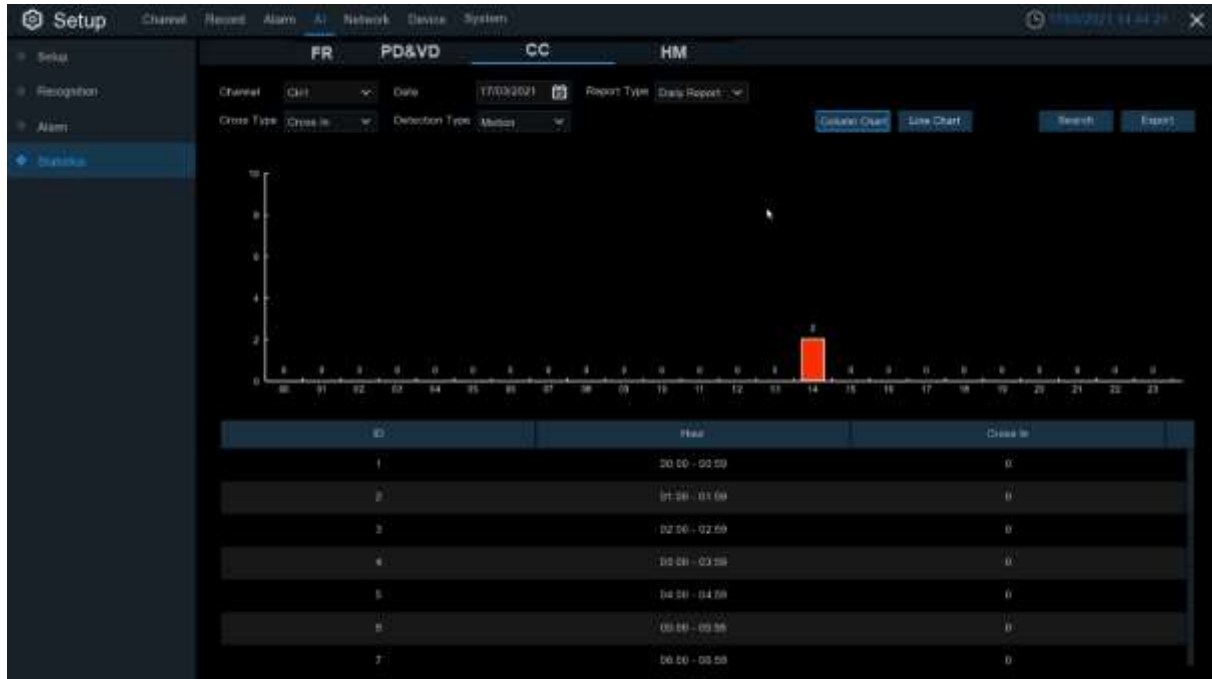

1. Choose the channel & date.
2. Choose the **Report Type**: Daily, Weekly, Monthly or Annually.
3. Choose the **Cross Type**: Cross In or Cross Out.
4. Choose the **Detection Type**: Motion, Person or Vehicle.
5. Click **Search** button, the result will be displayed in either **Column Chart** or **Line Chart**.
6. Click **Export** button if you want to export the data to USB memory.

5.4.4.4 HM (Heat Map)

You can check the heat map statistics in a certain period.

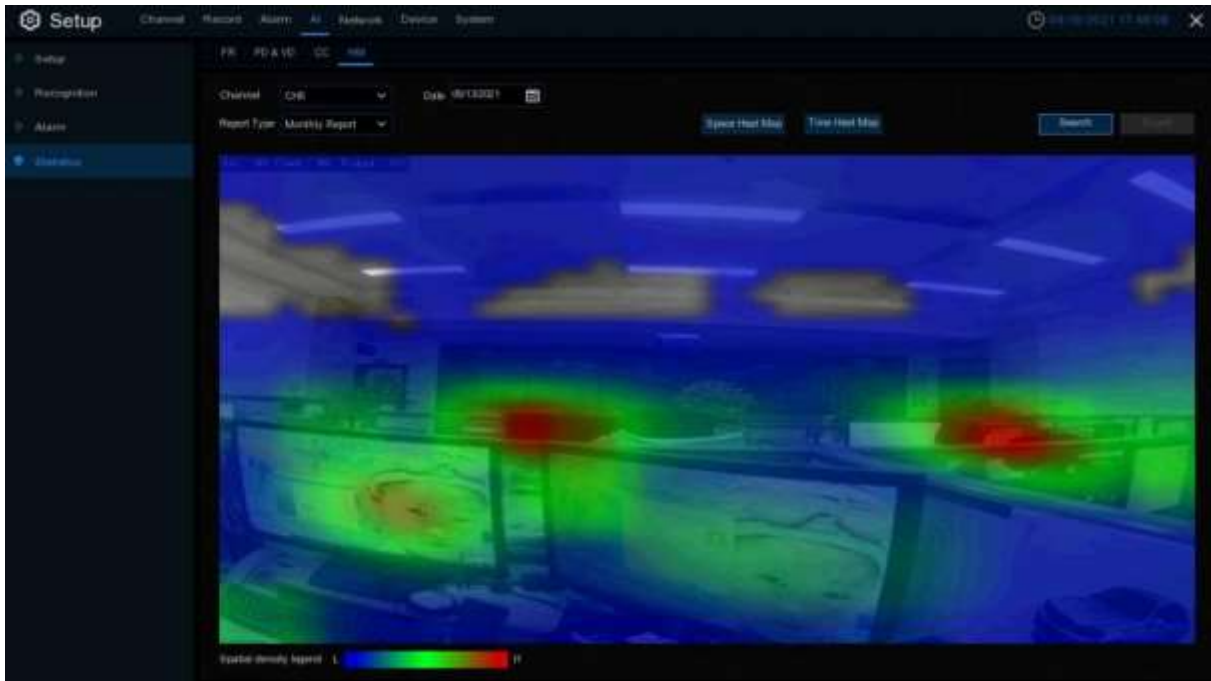

1. Choose the channel & date.
2. Choose the **Report Type**: Daily, Weekly, Monthly or Annually.
3. Set the **Start Hour / End Hour**.
4. Click **Search** button, the result will be displayed in either **Column Chart** or **Line Chart**.
5. The result can be displayed by Space & Time.

5.5 Network

This menu allows you to configure network parameters, such as PPPoE, DHCP. The most common types are DHCP. Most probably your network type is DHCP, unless the network is manually addressed. If you need an authentication user name and password to the Internet, then choose PPPoE.

5.5.1 General

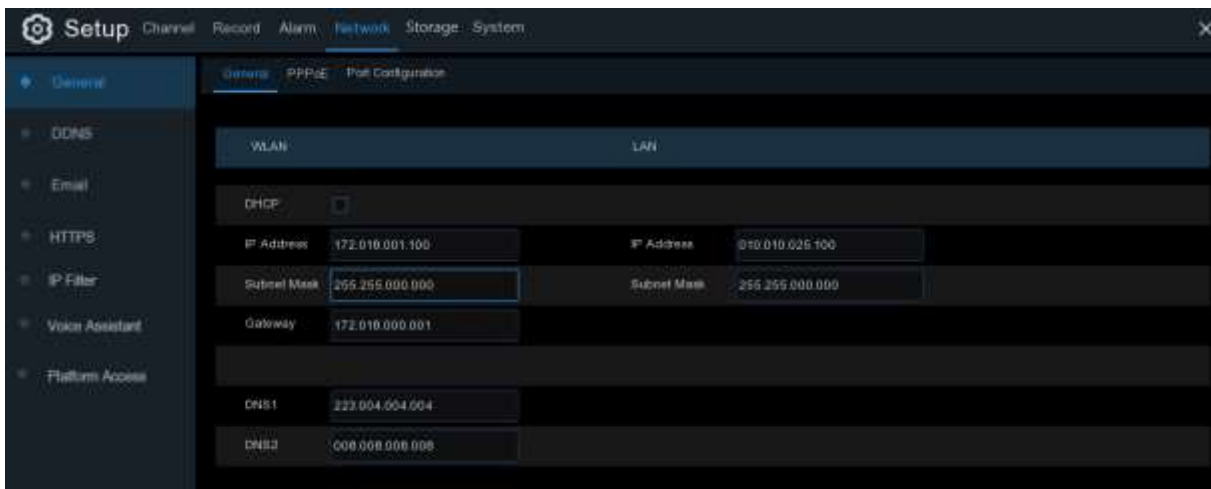

If you connect to a router allows to use DHCP, check the **DHCP** box. The router will assign automatically all the network parameters for your NVR. Unless the network is manually addressed below parameters:

IP Address: The IP address identifies the NVR in the network. It consists of four groups of numbers between 0 to 255, separated by periods. For example, “192.168.001.100”.

Subnet Mask: Subnet mask is a network parameter which defines a range of IP addresses that can be used in a network. If IP address is like a street where you live then subnet mask is like a neighborhood. The subnet address also consists of four groups of numbers, separated by periods. For example, “255.255.000.000”.

Gateway: This address allows the NVR to access the Internet. The format of the **Gateway** address is the same as the **IP Address**. For example, “192.168.001.001”.

DNS1/DNS2: DNS1 is the primary DNS server and DNS2 is a backup DNS server. Usually should be enough just to enter the DNS1 server address.

5.5.1.1 PPPoE

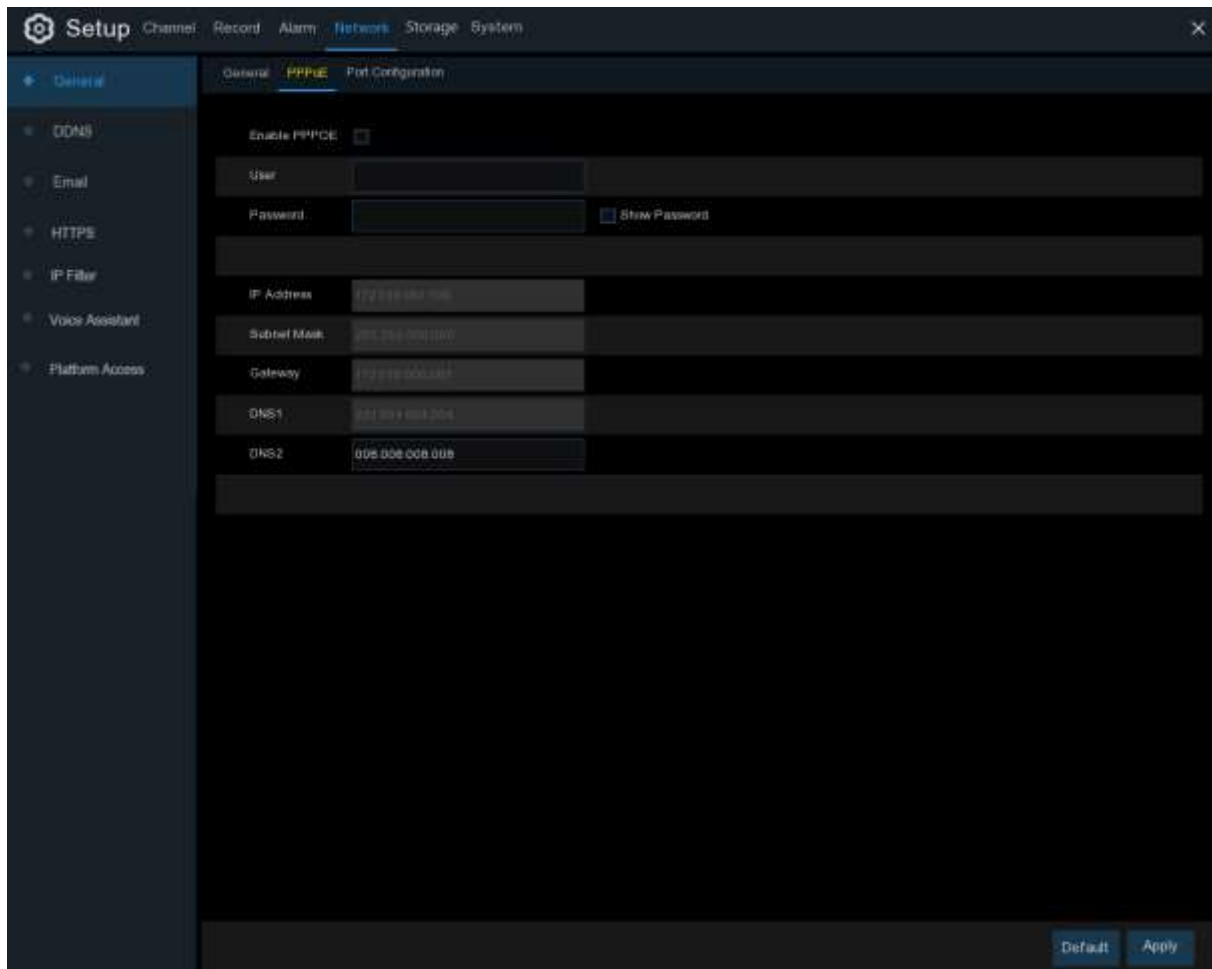

This is an advanced protocol that allows the NVR to connect to the network more directly via DSL modem.

Check the “Enable PPPOE” box, and then enter the User name & Password of the PPPoE.

Click **Apply** to save, system will reboot to activate the PPPoE setting.

5.5.1.2 Port Configuration

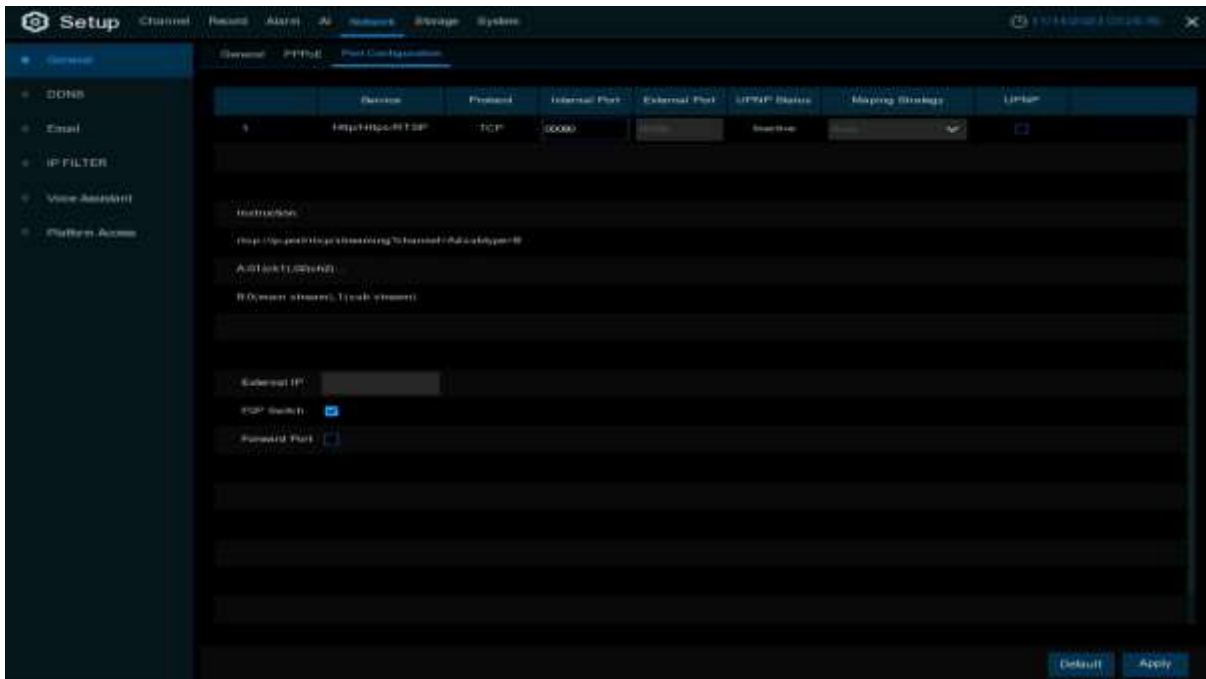

http/https/rtsp: This port is mostly used to log into your NVR via webpage or 3rd party streaming player by rtsp protocol. If the default port number (80) is used by other devices in the network, you may need to change it.

Internal Port: It is mostly used to access the NVR from the same LAN.

External Port: It is mostly used to access the NVR from a different LAN or internet. You need to forward the external ports to internet from your router manually. If you want to access your NVR via internet, which would be a little more complicated for users without network knowledge. Using UPNP would make it easier.

UPNP is a network protocol designed to allow network-connected devices to automatically obtain and forward the ports from the router.

1. Tick the checkbox of "**UPNP**".
2. Choose "**Auto**" on Mapping Strategy, the external port will be automatically obtained and forwarded from your router.
3. If you want to change the external port by manual, choose "**Manual**" on Mapping Strategy and then modify the port accordingly.

P2P Switch: Click to enable P2P function.

5.5.2 DDNS

This menu allows you to configure DDNS settings. The DDNS provides a static address to simplify remote connection to your NVR. To use the DDNS, you first need to open an account on the DDNS service provider's web page.

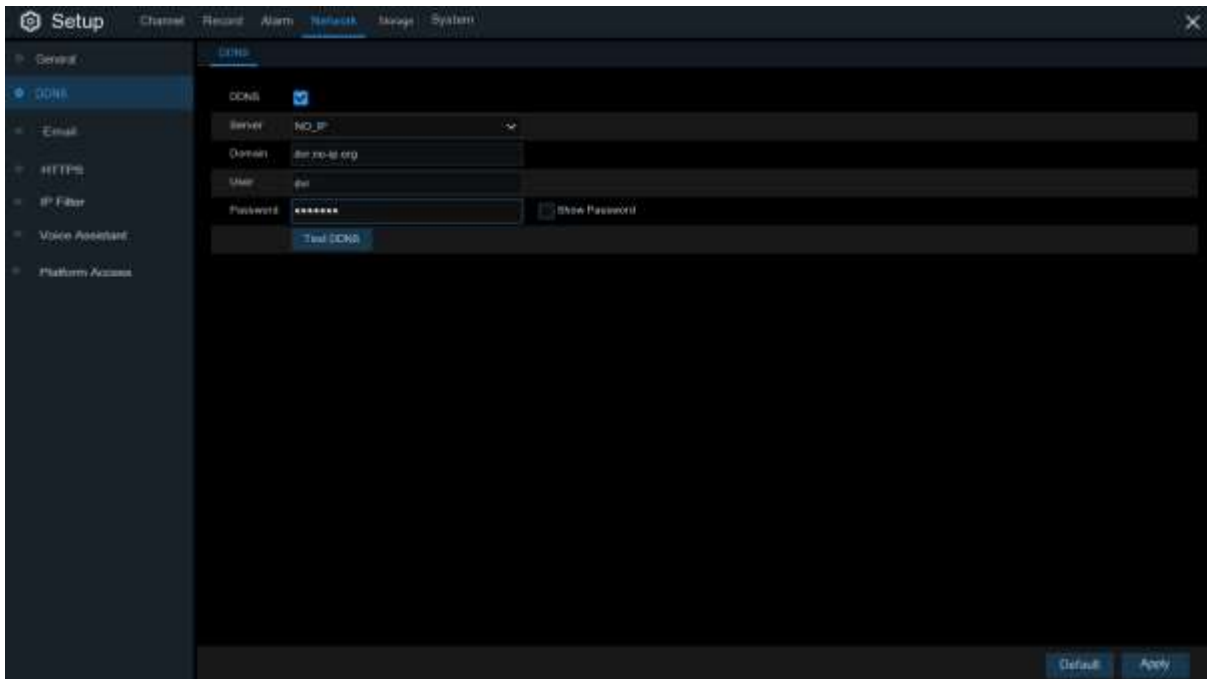

DDNS: Check to enable DDNS.

Server: Select the preferred DDNS server (DDNS_3322, DYNDNS, NO_IP, CHANGEIP, DNSEXIT, GeoDDNS).

Domain: Enter the domain name you created on the DDNS service provider's web page. This will be the address you type in the URL box when you want to connect remotely to the NVR via PC. For example: NVR.no-ip.org.

User/Password: Enter the user name and password you obtained when creating an account on the DDNS service provider's web page.

After all parameters are entered, click **Test DDNS** to test the DDNS settings. If the test result is "Network is unreachable or DNS is incorrect", check whether the network works fine, or the DDNS information is correct or not.

5.5.3 Email

This menu allows you to configure email settings. Complete these settings if you want to receive the system notifications on your email when an alarm is triggered, HDD becomes full, HDD is in error state, or Video Loss occurs.

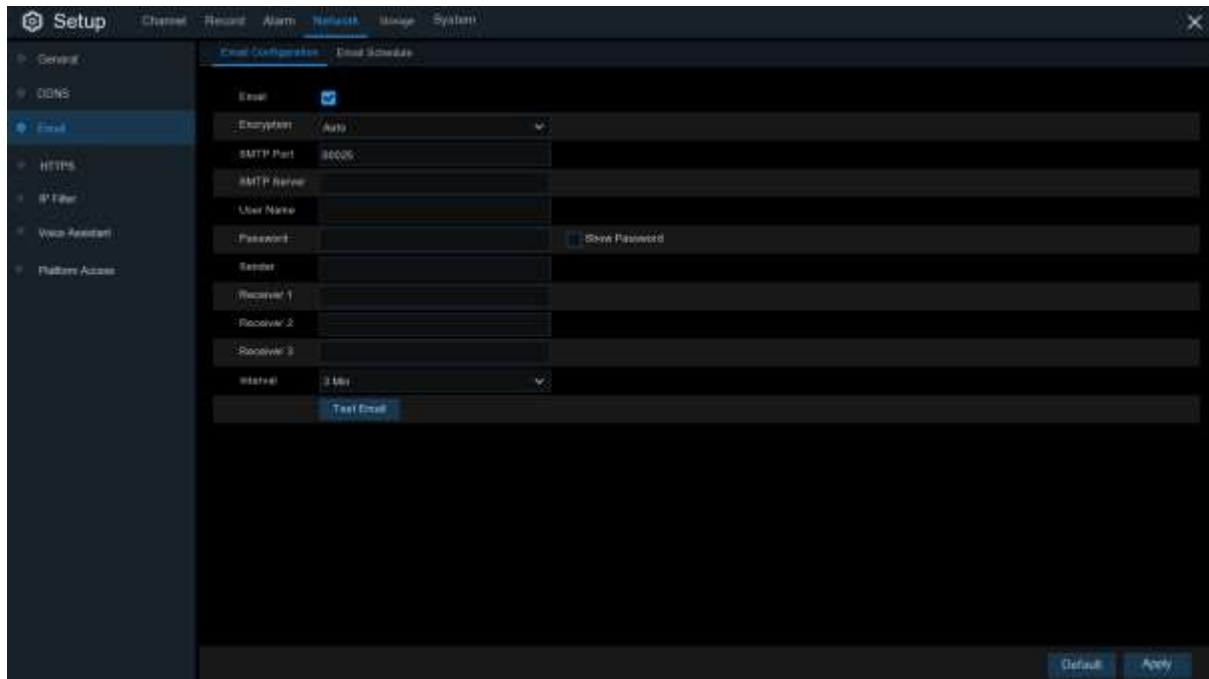

5.5.3.1 Email Configuration

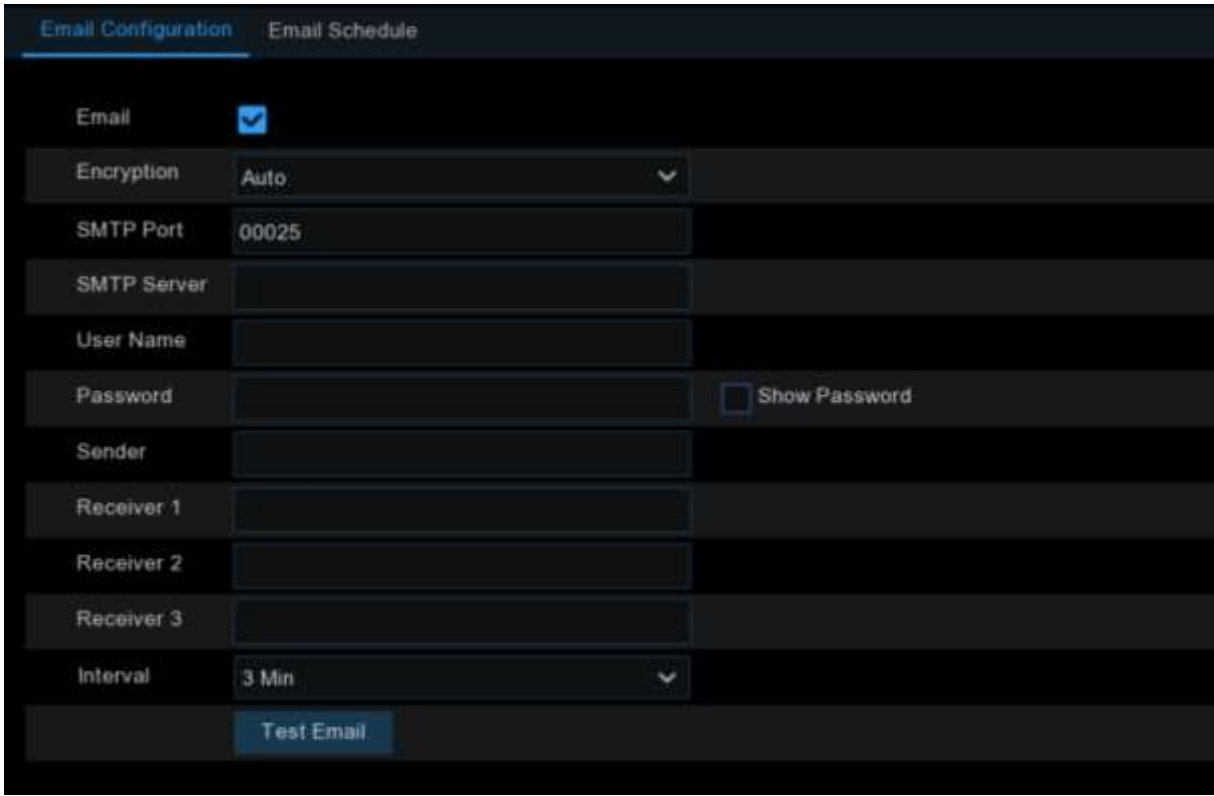

Email: Check to enable.

Encryption: Enable if your email server requires the SSL or TLS verification. If you are not sure, set to be **Auto**.

SMTP Port: Enter the SMTP port of your email server.

SMTP Server: Enter the SMTP server address of your email.

User Name: Enter your email address.

Password: Enter the password of your email.

Receiver 1~3: Enter the email address where you want to receive the event notifications from the NVR.

Interval: Configure the length of the time interval between the notification emails from the NVR.

To make sure all settings are correct, click **Test Email**. The system sends an automated email message to your inbox. If you received the test email, it means the configuration parameters are correct.

5.5.3.2 Email Schedule

You need to configure the schedule to fully implement the Email notification.

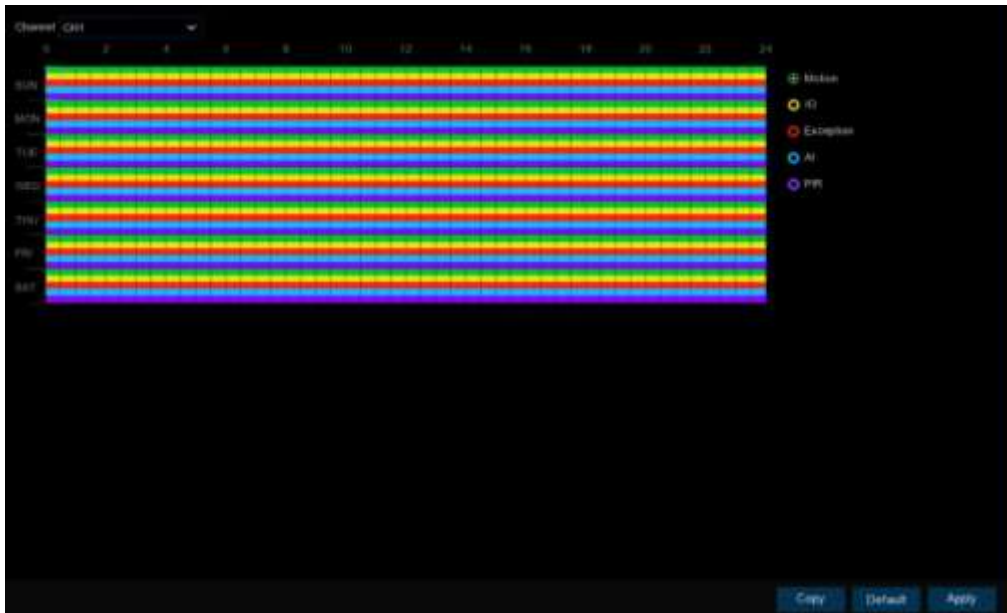

The color codes on email schedule have the following meanings:

Green: Slot for Motion detection.

Yellow: Slot for I/O Alarm (optional).

Red: Slot for Exception (HDD full, HDD error, or Video Loss).

Blue: Slot for Intelligent Analysis / AI detection.

5.5.4 IP Filter

This function allows you to set a allow list and black list so that only the IP addresses on the allow list can connect to the device.

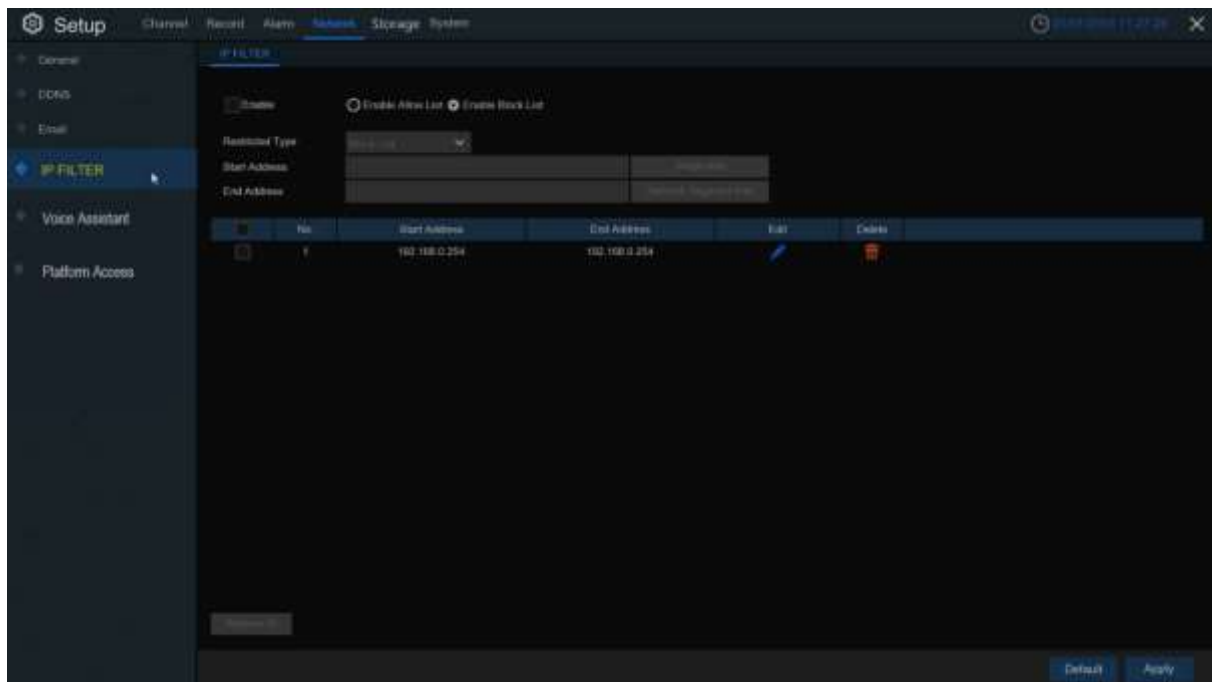

- **Enable:** Enable or disable the IP filter function. Once enabled, you can select to filter the IP addresses by allow list or black list.
- **Restricted Type:** Select the list (**Black List** or **Allow List**) to finish relevant configurations.
- **Single Add:** Enter the IP address to add to the list.
- **Network Segment Add:**
 - ⊙ **Start Address:** Input the **Start Address**.
 - ⊙ **End Address:** Input the **End Address**.

5.5.5 Voice Assistant

This menu allows you to project a preview onto the screen via Amazon or Google cast Screen.

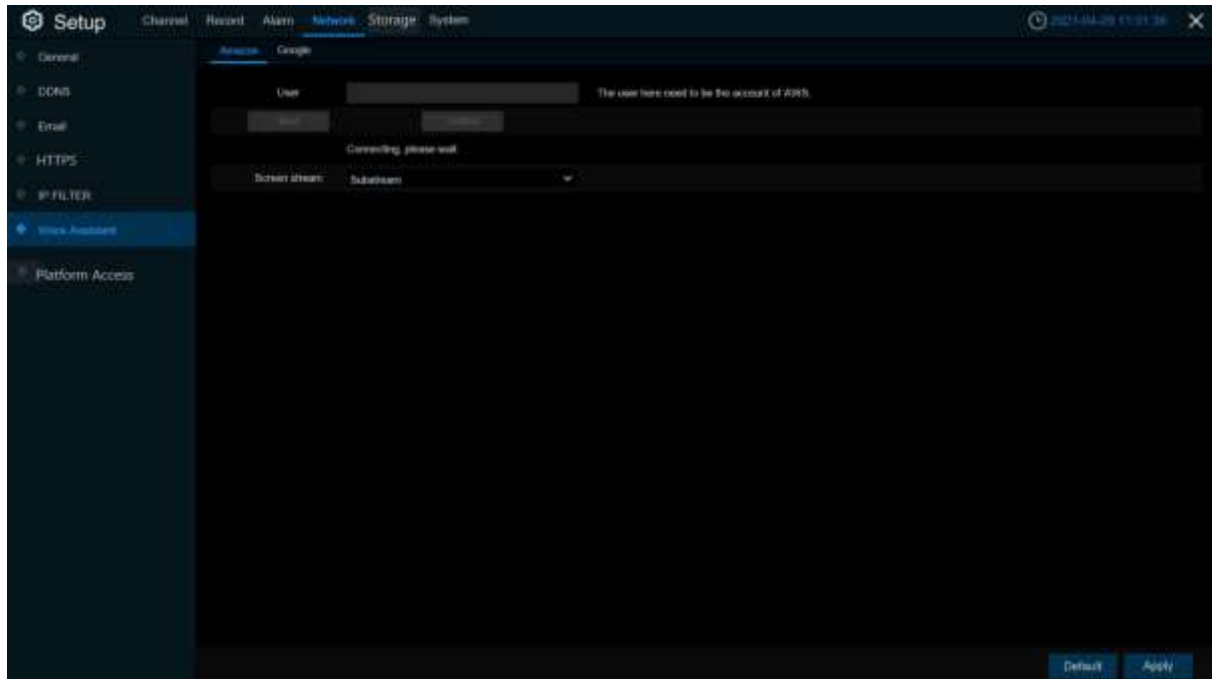

- **User:** Input the Google / AWS account.
- **Bind:** Click to bind the account.
- **UnBind:** Click to unbind the account.
- **Screen stream:** Set the cast screen stream.

For Amazon: After the binding is finished, give a voice command Discover to the remote controller of fire stick TV, then can add the device bound to the linked account. Open Amazon Alexa APP, click the **Device** at the right corner to check the added devices.

5.5.6 Platform Access

5.5.6.1 Onvif

Enable this function to allow devices to be searched and added by other third-party platforms through the ONVIF protocol.

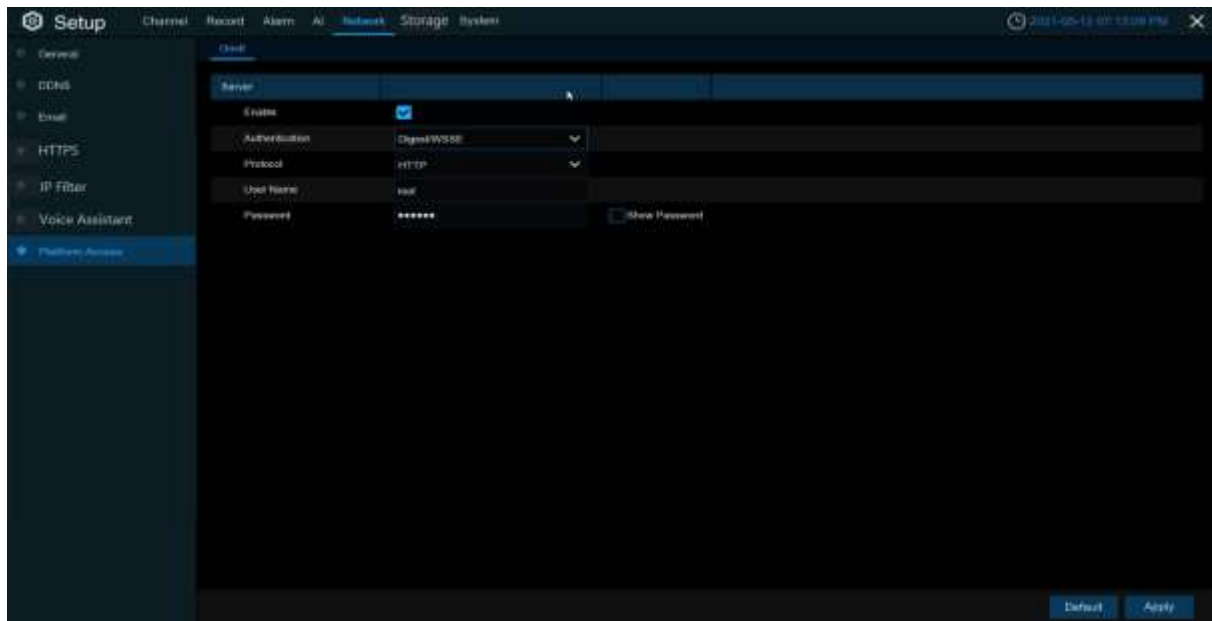

Enable: Enable switch. If turn off this menu, the service will be failed.

Authentication: Login authentication mode, authentication methods including Digest_sha256, Digest, Digest/WSSE, and WSSE.

Protocol: Connection protocol

Username: Login user name

Password: Login user password

Note: The stream connected by the back end through the ONVIF protocol are all the pictures of the first channel.

5.5.6.2 RTMP

The audio and video streams of the NVR channels can be pushed to the YouTube website by RTMP for live broadcasting. To use this function, you need to do the following: Register a YouTube account, create a live streaming studio, set the URL and live code of the live streaming studio, set the live server address bar for the device, and enable and configure the code stream type and live broadcasting channels. After saving the configuration, you can go to the YouTube live room to refresh the page to watch live broadcasting.

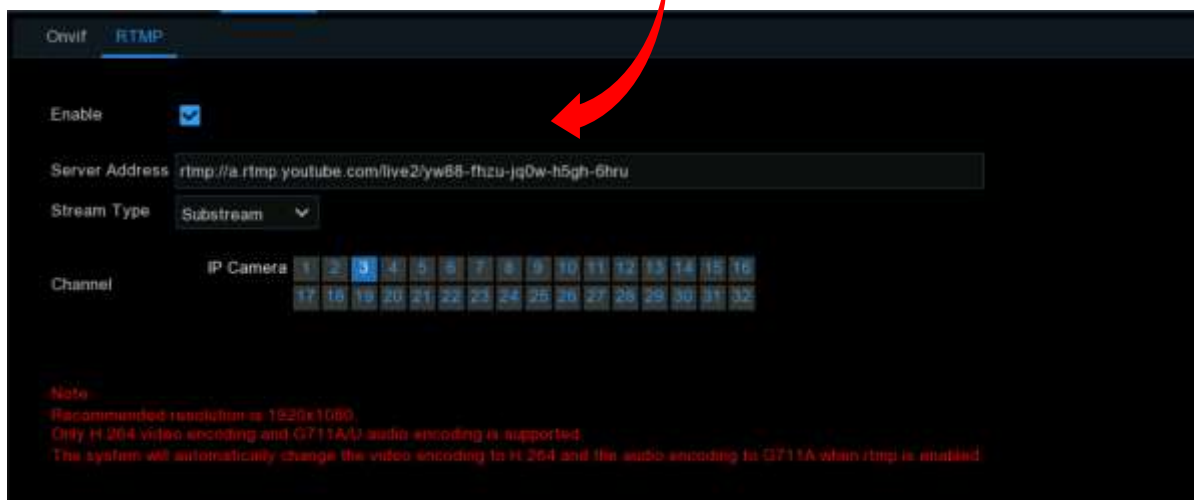
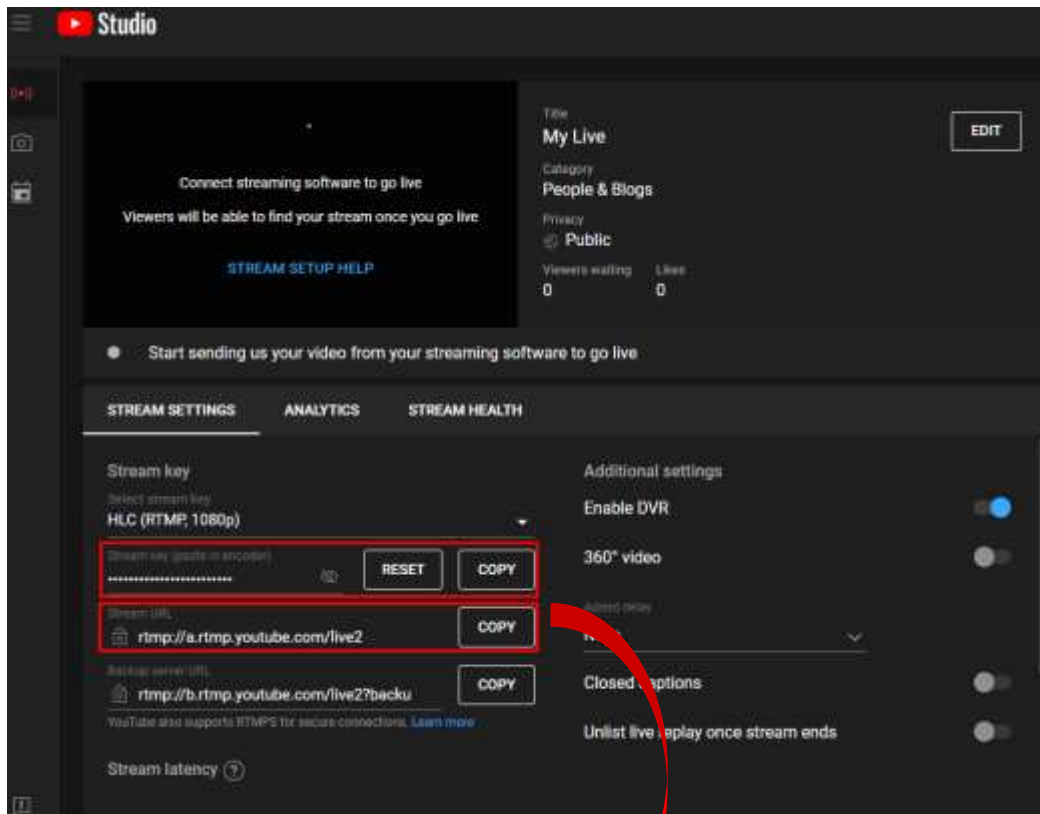

Enable: Used to set whether to enable the RTMP live broadcasting function.

Server Address: Enter the live broadcasting address and live code of the YouTube server. (Note: "/" is used between the live broadcasting address and live code of the YouTube server.)

Stream Type: Select the stream type of the live broadcasting channel. Both main stream and substream are supported.

Channel: Select the channel for live broadcasting. Only one channel can be selected.

Note:

1. To ensure the live broadcasting effect, it is recommended that the resolution of the stream not exceed 1920 × 1080.

2. Live broadcasting can be conducted for only the data streams of H.264 video encoding format and G711A/U audio encoding format.
 3. A YouTube live code can be set for only one device and cannot be reused.
-

5.6 Storage

In this section, you can configure the internal HDD function.

5.6.1 Disk

This menu allows you to check & configure the internal HDD(s). You need to format the HDD only at the first startup and if you replace a new HDD.

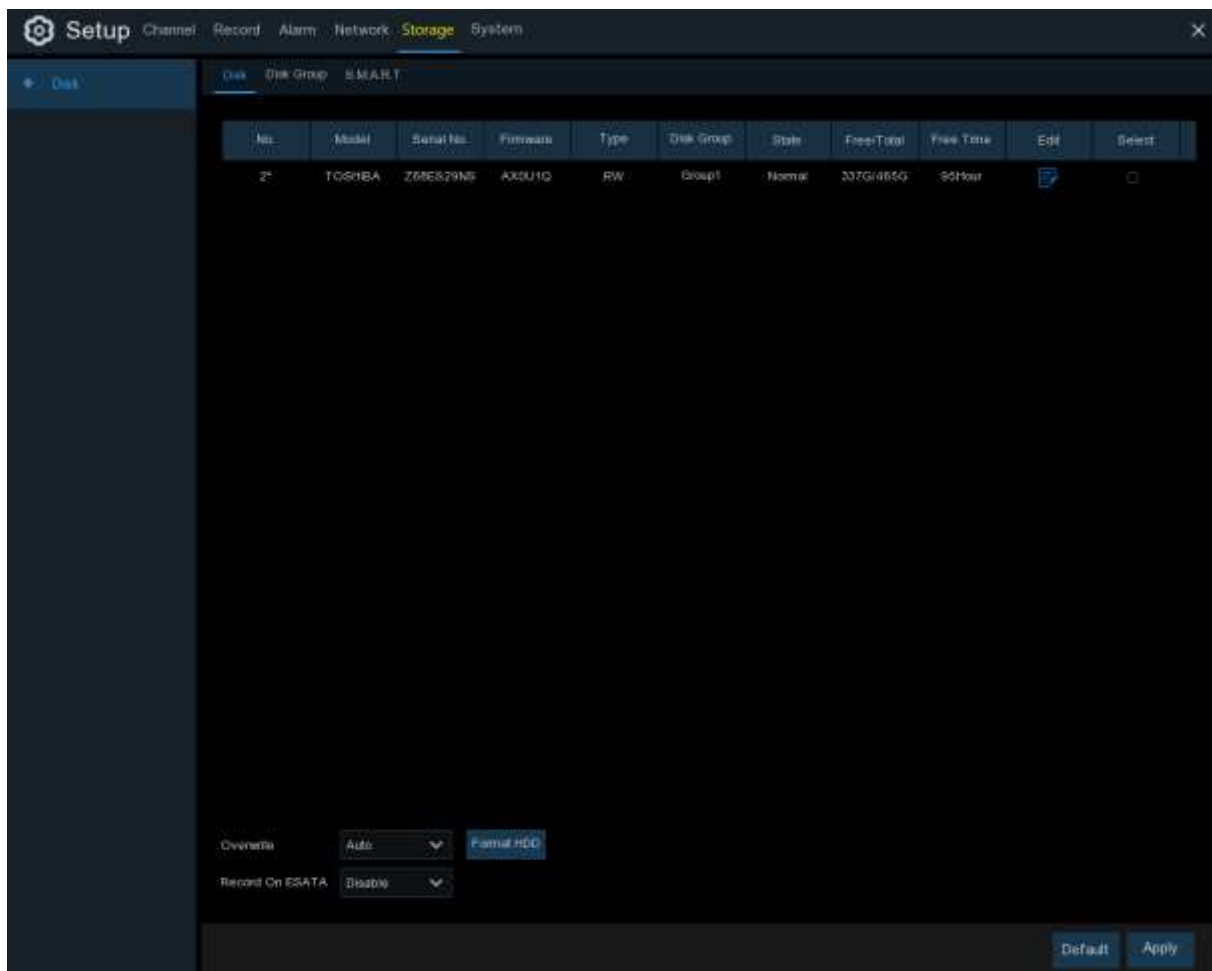

Format HDD: Select the HDD you want to format and then click **Format HDD**. To start formatting, you need to enter your user name and password and then click **OK** to confirm to continue formatting.

Overwrite: Use this option to overwrite the old recordings on the HDD when the HDD is full. For example, if you choose the option 7 days then only the last 7 days recordings are kept on the HDD. To prevent overwriting any old recordings, select **OFF**. If you have disabled this function, check the HDD status regularly, to make sure the HDD is not full. Recording will be stopped if HDD is full.

Record on ESATA: This menu only displayed when your NVR is coming with an e-SATA port on the rear panel. It will allow to record the video to external e-SATA HDD to enhance your HDD capacity. If the e-SATA recording function is enabled, e-SATA backup function will be disabled.

If your NVR supports to install multiple HDDs, the edit icon  appears in your system, you can click it to edit the HDD as below:

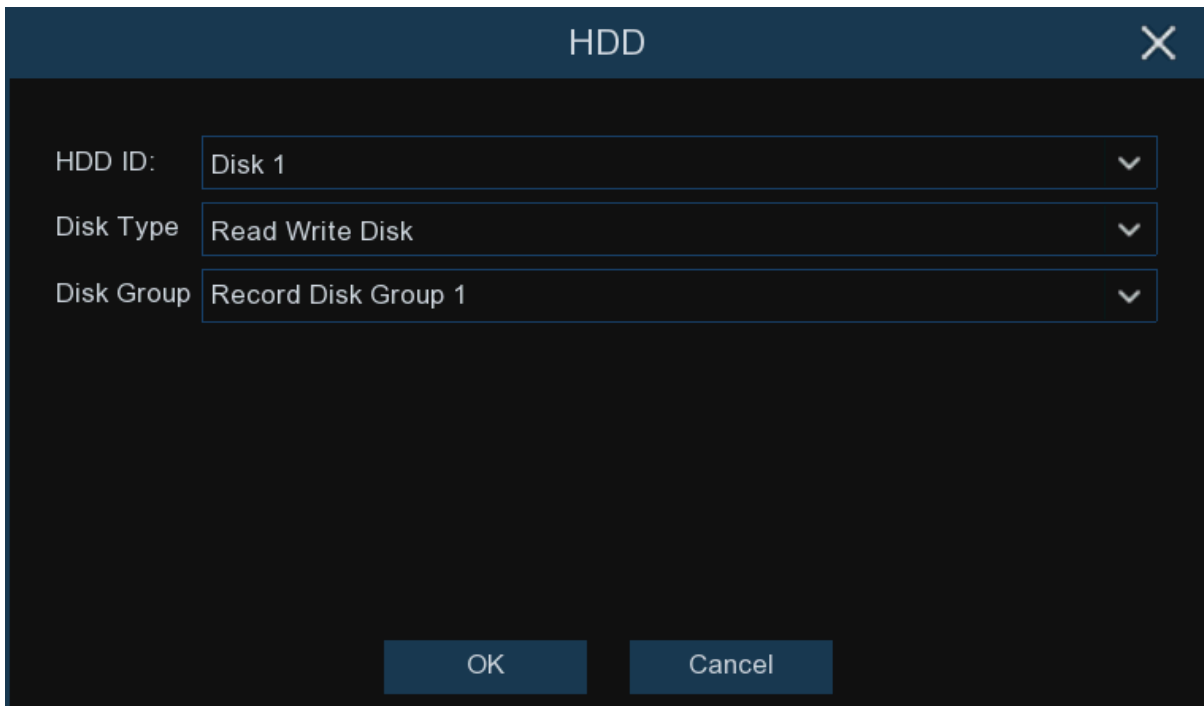

Disk Type: Read-write, read-only, and redundant.

Read-write mode is the normal status for a HDD to save recording or search recording to play.

To prevent important video data from being overwritten during cyclic recording, the HDD can be set as **Read-only** mode. New recording will be not able to save into this read-only HDD. You can still search recording from this read-only HDD to play.

A **Redundant** HDD can be used to automatically backup video footage on the recording (read-write) hard drive. When a redundant HDD is set, the system can be set to record cameras in parallel to both the recording hard drive and the redundant hard drive in case of hard drive failure.

5.6.1.1 Disk Group

If your NVR supports to install multiple HDDs, you can configure the HDD to be different groups. HDD groups allow you to balance recordings across multiple hard drives. For example, you can record channels 1~4 to one hard drive and 5~8 to a second hard drive. This can reduce the amount of wear on the hard drives and may extend the life of the hard drives.

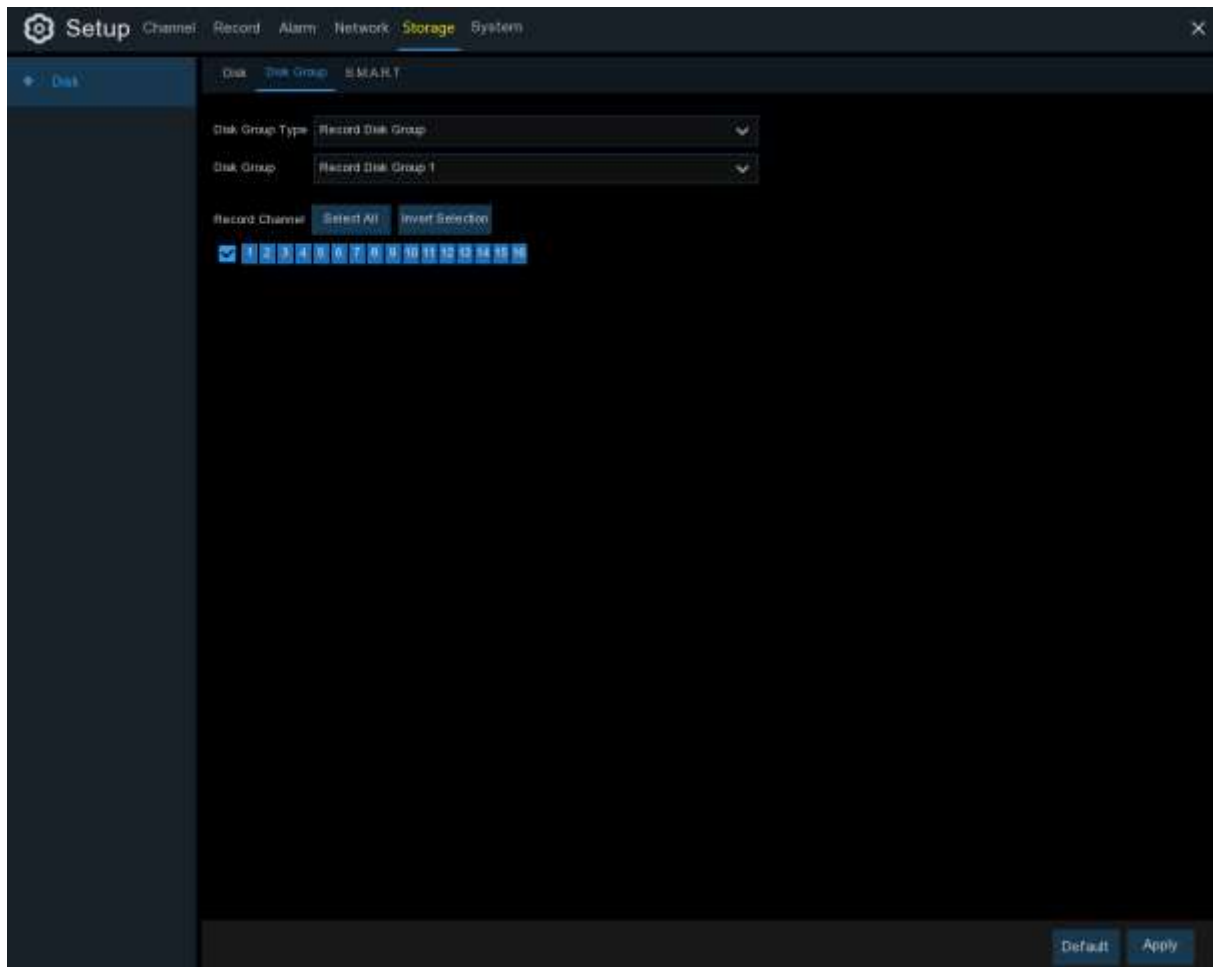

1. Use the dropdown next to **Disk Group Type** to select the type of group to configure.
2. Use the dropdown next to **Disk Group** to select the specific group within the selected group type.
3. Click the numbered boxes representing channels to record channels to HDDs in the selected group.
4. Click **Apply** to save.

5.6.1.2 S.M.A.R.T

This function can be used to display technical information on the hard drive installed inside your NVR. You can also perform a test (there are three types available) to evaluate and detect potential drive errors.

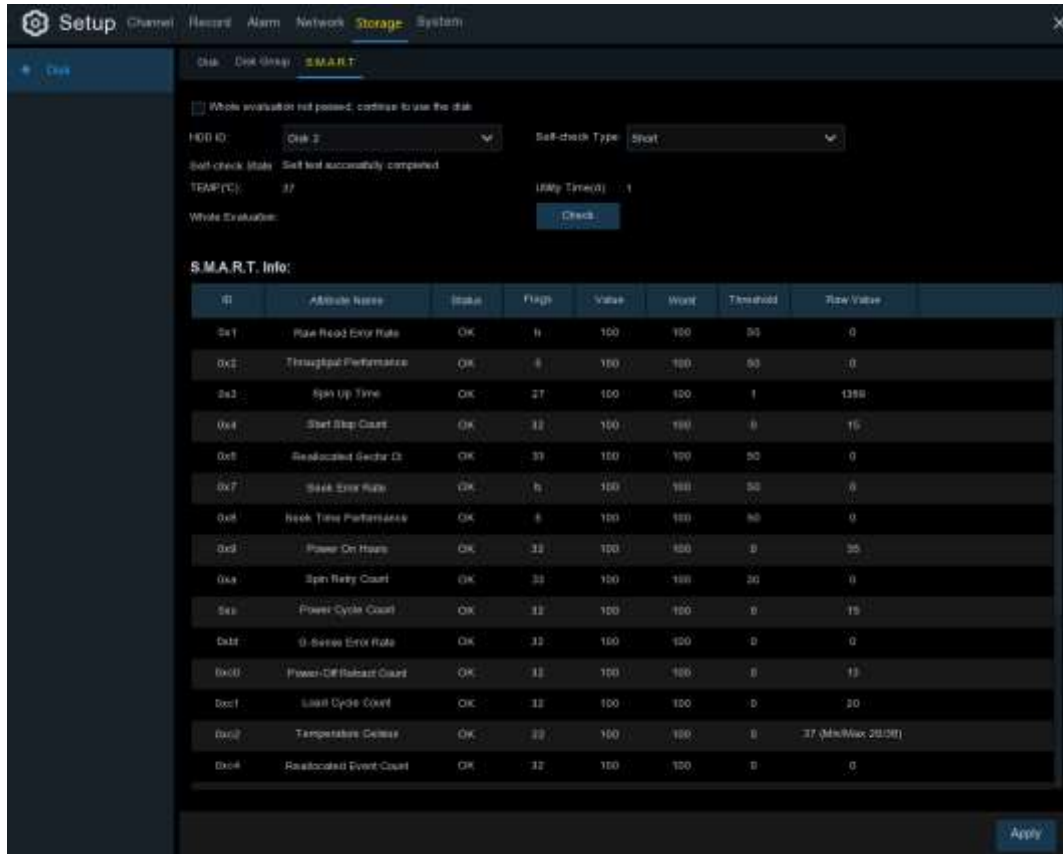

Whole Evaluation not passed, continue to use the disk: If for some reason the hard drive has developed a fault (such as one or more bad sectors), you can instruct your NVR to continue saving to the drive.

Self-check Type: There are three types available:

Short: This test verifies major components of the hard drive such as read/write heads, electronics and internal memory.

Long: This is a longer test that verifies the above as well as performing a surface scan to reveal problematic areas (if any) and forces bad sector relocation

Conveyance: This is a very quick test that verifies the mechanical parts of the hard drive are working.

Note: When performing a test, your NVR will continue to work as normal. If an HDD S.M.A.R.T error found, the HDD can be continued to use, but there will be a risk to lose recording data. It is recommended to replace a new HDD.

5.6.2 Cloud

Cloud function allows to upload pictures and videos to your cloud storage. It supports Dropbox and Google Drive storage now.

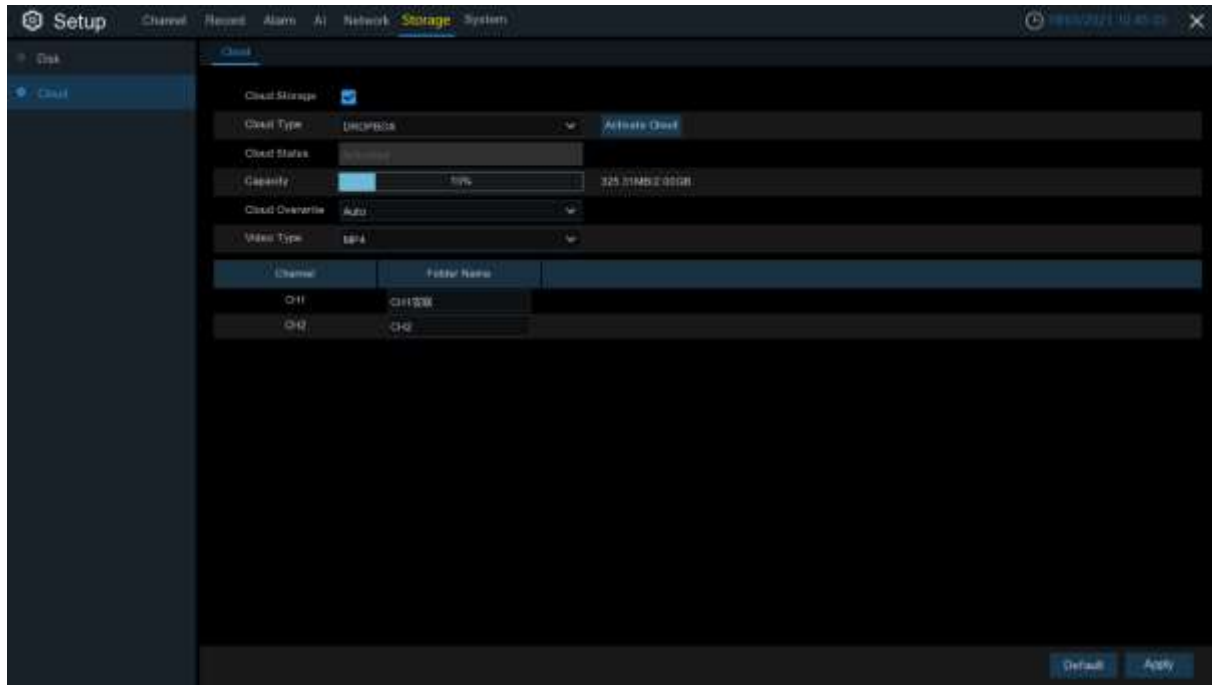

Cloud Type: To choose Dropbox or Google Drive.

Cloud Overwrite: Use this option to overwrite the old recordings on the storage when it is full. For example, if you choose the option 7 days then only the last 7 days recordings are kept on the storage. To prevent overwriting any old recordings, select **OFF**. If you have disabled this function, please check the cloud storage status regularly, to make sure the capacity is not full. Recording will be stopped if the space is full.

Video Type: To choose the video format you want to upload.

Take Dropbox as example:

1. Check **Cloud Storage** to enable the function.
2. Choose Dropbox from **Cloud Type**.
3. Set the **Overwrite**.
4. Choose the **Video Type**.
5. Define the folder name for each channel.
6. Click the **Activate Cloud** button, the system will send an activation letter to your receiver email box which you have set in the Email Setup page.

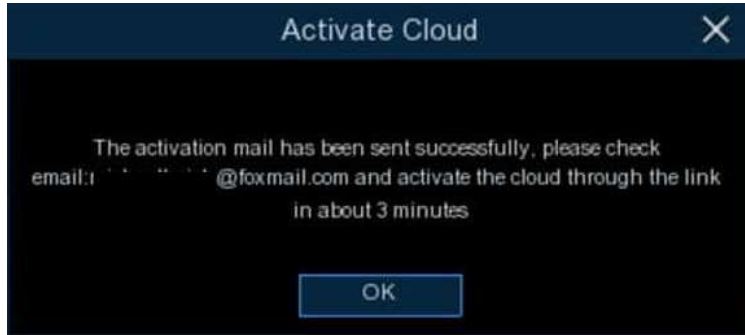

7. Login your email box and click the link in the email content. It will turn to the cloud server authorization login page. Input your Dropbox account name and password to login.

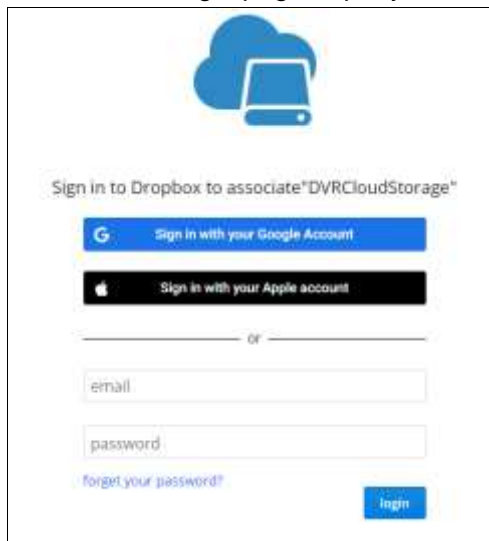

8. Input the NVR's local IP address and web port, and then click **Authorize**.

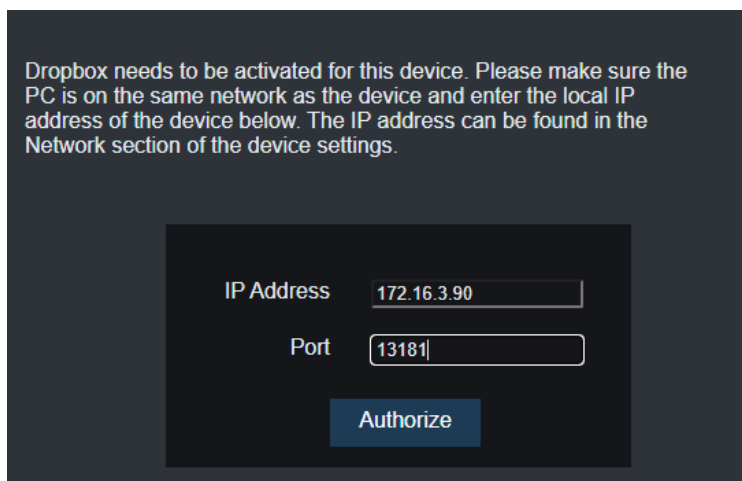

9. Input the NVR's user name and password and then click OK.

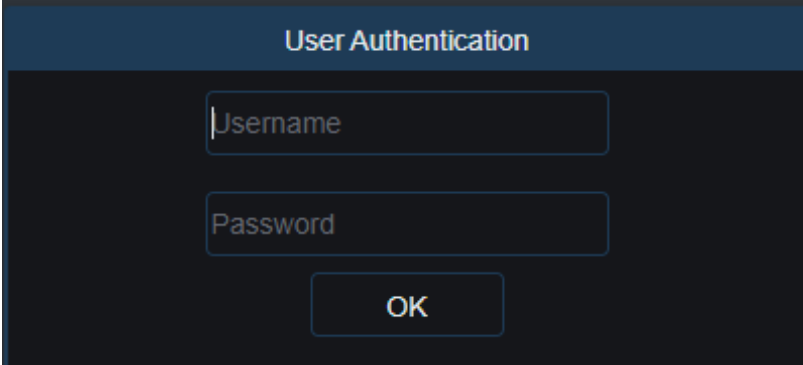

A dark-themed dialog box titled "User Authentication". It contains two input fields: "Username" and "Password". Below the fields is a single button labeled "OK".

10. Authorization finished; the webpage will turn to your Dropbox.

Authorization succeeded! Return [Dropbox](#)
It will automatically jump in 1 seconds!

11. The Cloud has completed the setup if you find a new folder named by your NVR device name and MAC address in the Dropbox storage. Your alarm pictures and videos will be uploaded to this folder.

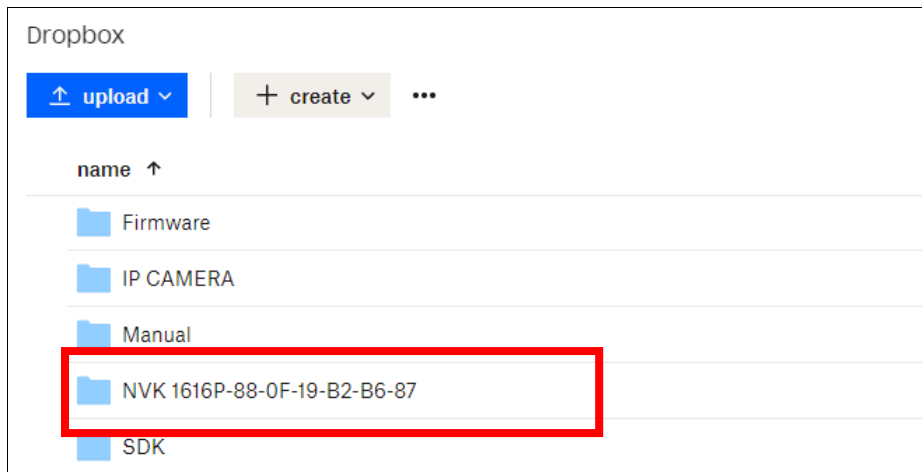

5.6.3 FTP

This menu allows you to enable FTP function to view and load captured snapshots from NVR to your storage device over FTP. This is only applicable to UA-SNVRL810-P / UA-SNVR3240-N.

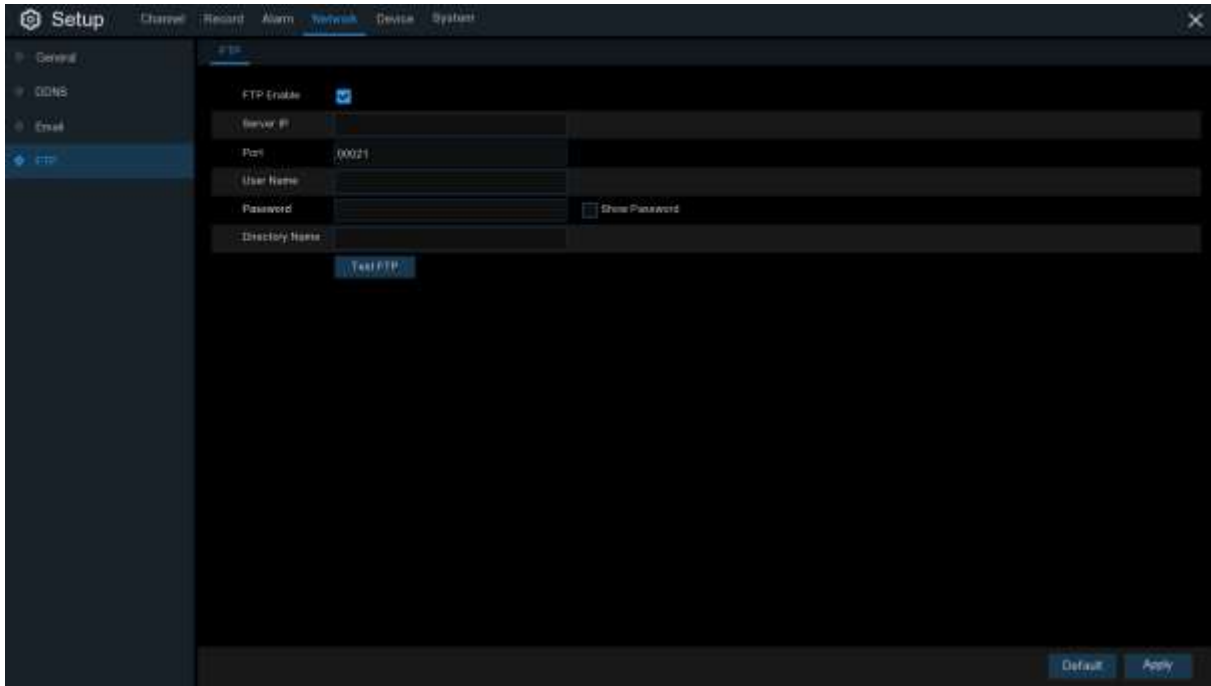

FTP Enable: Click to enable FTP function.

Server IP: Enter your FTP server IP address or domain name.

Port: Enter the FTP port for file exchanges.

Name/ Password: Enter your FTP server user name and password.

Directory Name: Enter the default directory name for the FTP file exchanges.

Test FTP: Click to test the FTP settings.

Note: To view images or to play videos uploaded to FTP server, make sure you use [USA Vision Player](#).

5.7 System

Change general system information such as date, time and region, edit passwords and permissions, and more.

5.7.1 General

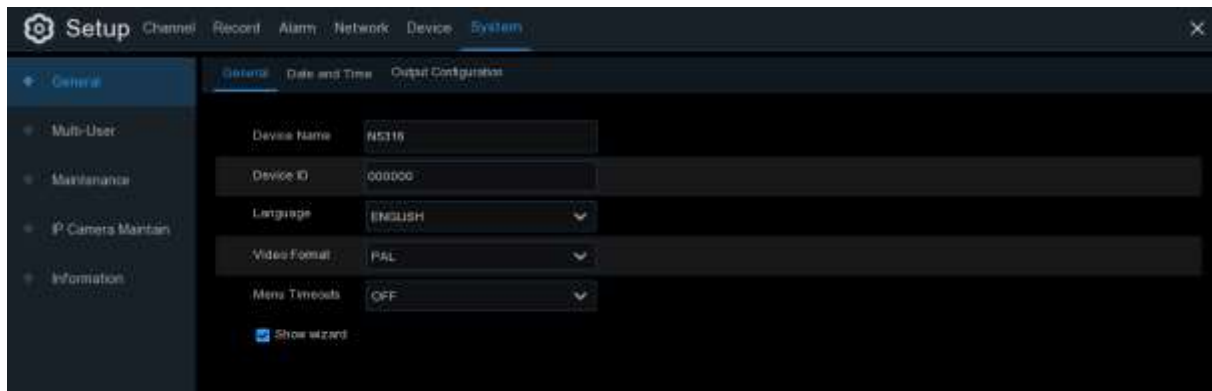

Device Name: Enter the desired name for your NVR. The name can include both letters and numbers.

Device ID: Enter the desired ID for your NVR. The device ID is used to identify the NVR, and can only be composed of numbers. For example, 2pcs NVRs are installed in the same place, the Device ID is 000000 for one of the NVRs, and 111111 for another NVR. When you want to operate the NVR with a remote controller, both of the NVR may receive the signal from controller & act at the same time. If you want to control only the NVR with ID 111111, you can input the Device ID 111111 in login page with remote controller for further operations.

Language: Select a language you would like the system menus to be displayed in. Multiple languages are available.

Video Format: Select the correct video standard for your region.

Menu Timeouts: Click the drop-down menu to select the time your NVR will exit the Main Menu when idle. This function is set to “OFF” by default (password protection will be temporarily disabled).

Show Wizard: Click the checkbox if you would like to display the Startup Wizard each time you turn on or reboot your NVR.

5.7.1.1 Date and Time

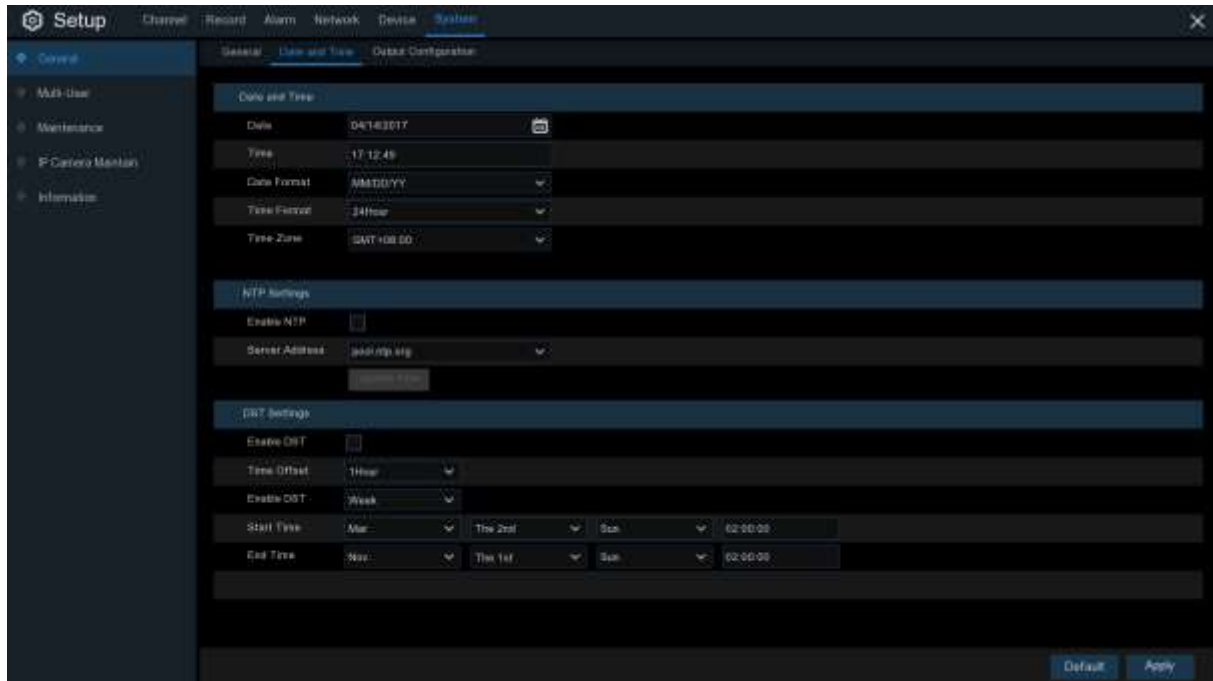

Date & Time

Date: Click the calendar icon to change the date.

Time: Click the dialogue box to change the time.

Date Format: Select the preferred date format.

Time Format: Select the preferred time format.

Time Zone: Select a time zone relevant to your region or city.

5.7.1.2 NTP Settings

The NTP (Network Time Protocol) function allows your NVR to automatically sync its clock with a time server. This gives it the ability to constantly have an accurate time setting (your NVR will periodically sync automatically).

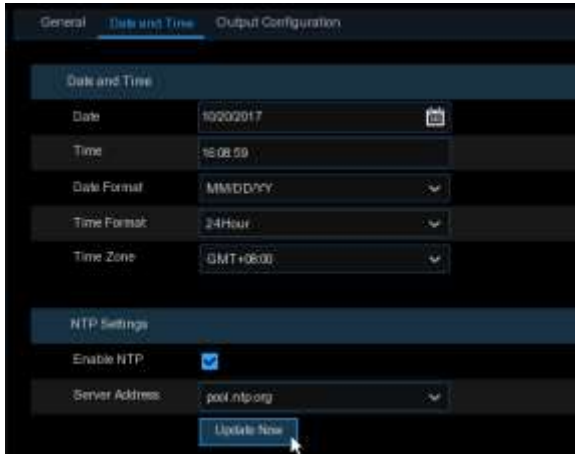

Check to enable the **NTP**, and select a **Server Address**, click Update Now to manually sync the date & time.

Click **Apply** to save your settings.

When NTP function is enabled, system will update the system time at 00:07:50 per day, or every time when the system is starting up.

5.7.1.3 DST Settings

The DST (Daylight Saving Time) function allows you to select the amount of time that Daylight Saving has increased by in your particular time zone or region.

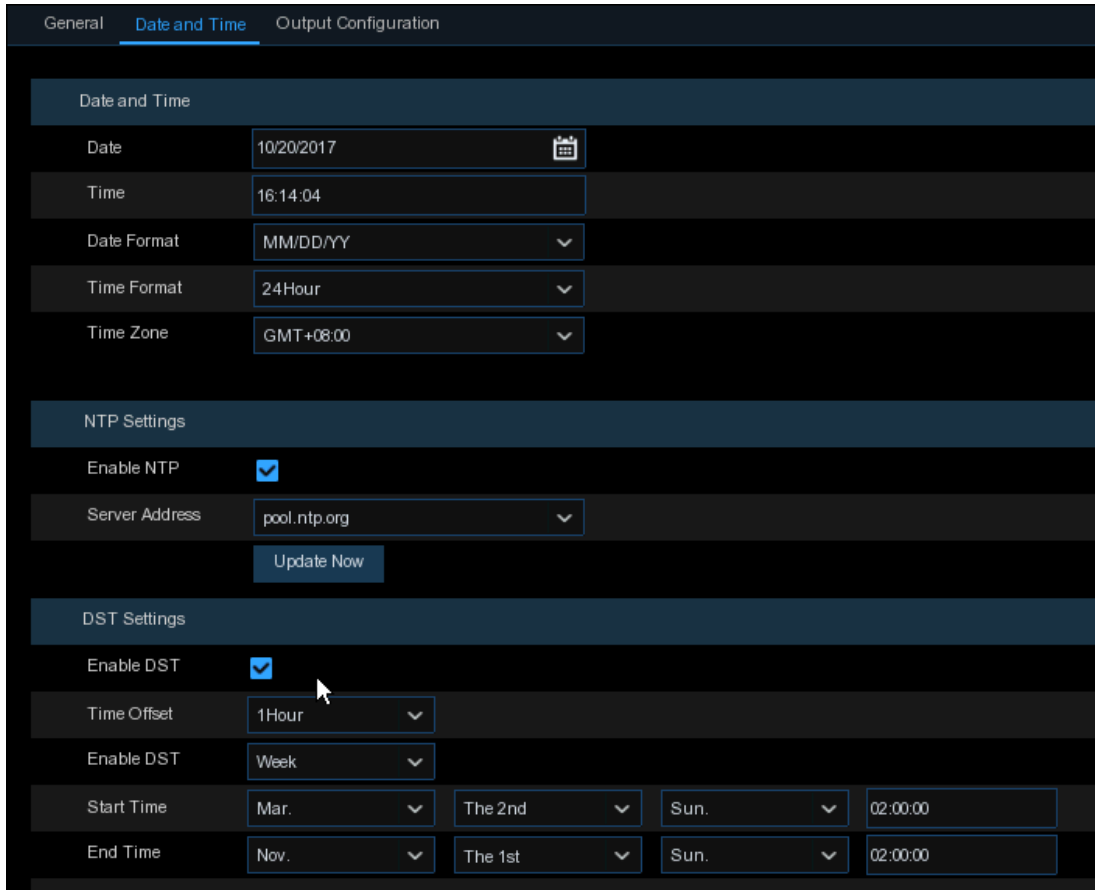

Date and Time				
Date	10/20/2017			
Time	16:14:04			
Date Format	MM/DD/YY			
Time Format	24Hour			
Time Zone	GMT+08:00			
NTP Settings				
Enable NTP	<input checked="" type="checkbox"/>			
Server Address	pool.ntp.org			
Update Now				
DST Settings				
Enable DST	<input checked="" type="checkbox"/>			
Time Offset	1 Hour			
Enable DST	Week			
Start Time	Mar.	The 2nd	Sun.	02:00:00
End Time	Nov.	The 1st	Sun.	02:00:00

Enable DST: If Daylight Saving applies to your time zone or region, check this option to enable.

Time Offset: Select the amount of time that Daylight Saving has increased by in your time zone. This refers to the difference in minutes, between Coordinated Universal Time (UTC) and the local time.

Enable DST: You can select how Daylight Saving starts and ends:

Week: Select the month, a particular day and time when Daylight Saving starts and ends. For example, 2 a.m. on the first Sunday of a particular month.

Date: Select the start date (click the calendar icon), end date and time when Daylight Saving starts and ends.

Start Time / End Time: Set the start time and end time for Daylight Saving.

5.7.2 Output Configuration

This menu allows you to configure video output parameters.

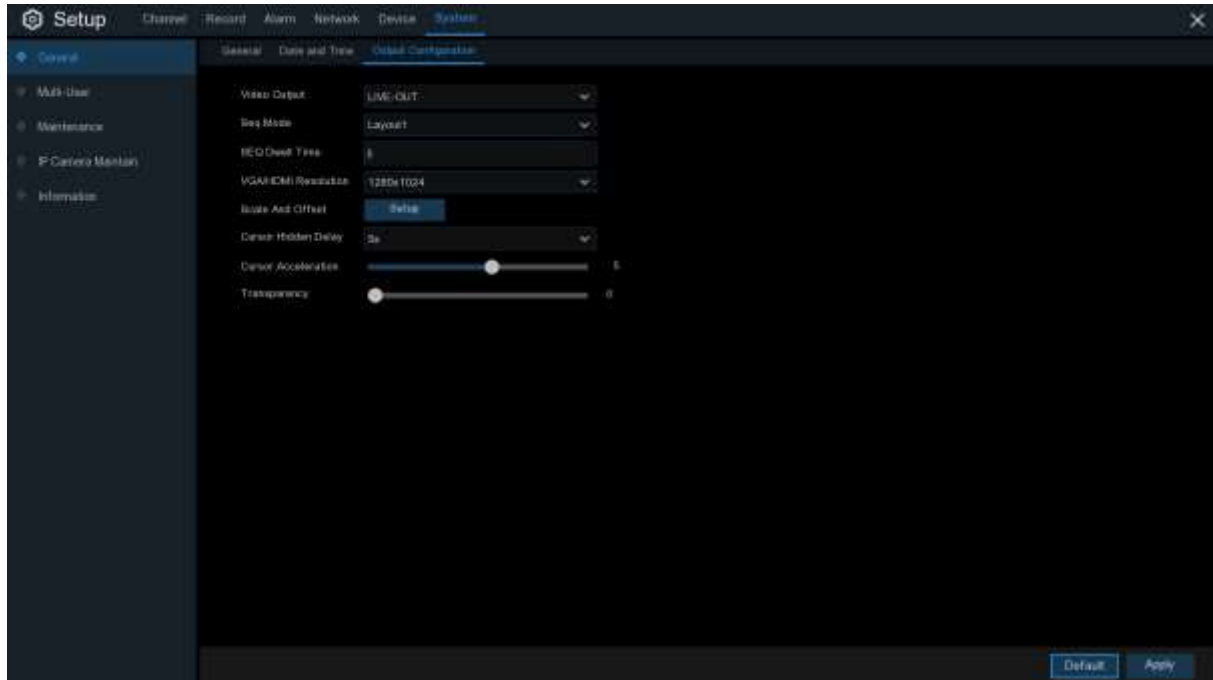

Video Output: To choose the output options:

LIVE-OUT is used to configure the main output parameters.

5.7.2.1 LIVE-OUT

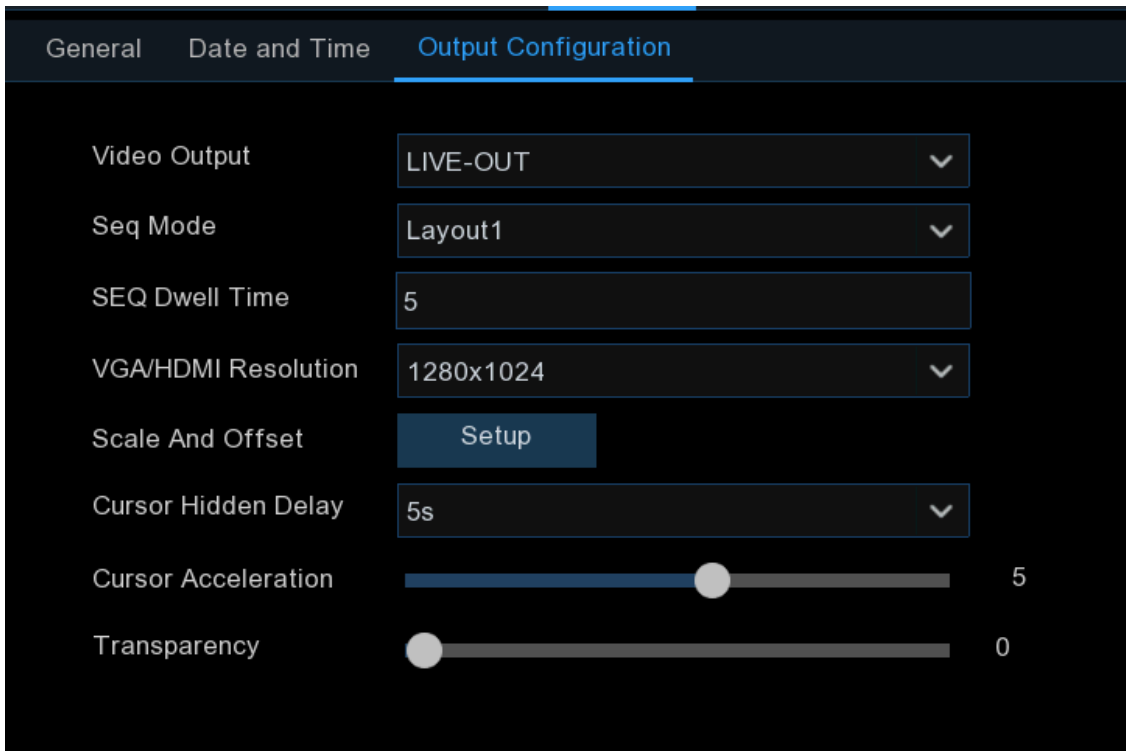

Choose **LIVE-OUT** from the Video Output drop-down menu.

SEQ Mode: Select how many video channels you would like to display when your NVR is in sequence mode.

SEQ Dwell Time: Enter in seconds the maximum length of time you would like to display a video channel in sequence mode before displaying the next video channel (300 seconds is the maximum).

Output Resolution: Select a display resolution that is suitable for your TV. 1920 x 1080 will suit most TVs. If your NVR supports 4K output resolution, you can select either 2K (2560 x 1440) or 4K (3840 x 2160) to take advantage of the higher resolution that your 4K TV provides.

Scale and Offset: The NVR supports to adjust the size & position of the display screen to match your monitor or TV. Click **Setup** button to adjust.

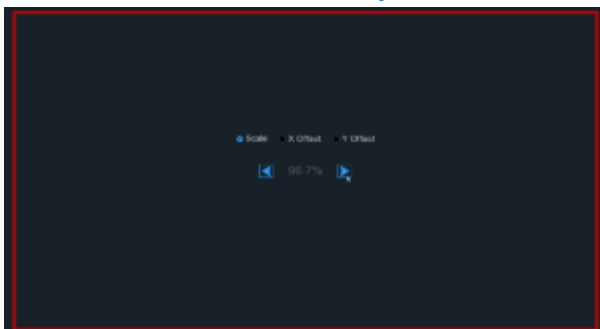

Scale: To adjust the size of the displayed screen by scale.

X Offset: To move the displayed screen to left or right.

Y Offset: To move the displayed screen to up or down.

Click once or long press the left button of your mouse on the arrow to adjust the size and position, or you can scroll the wheel of the mouse to adjust. Click the right button of your mouse to exit, and click **Apply** to save your modifications.

Cursor Hidden Delay: Click the drop-down menu to select the time your NVR will hide the mouse cursor when idle. You can also disable this by selecting “OFF” (password protection will be temporarily disabled).

Cursor Acceleration: To adjust the speed to move the mouse cursor.

Transparency: Click and hold the slider left or right to change how transparent the Menu Bar and Main Menu will appear on-screen. Adjust accordingly.

5.7.3 Multi-user

This menu allows you to configure the user name, password and user permission.

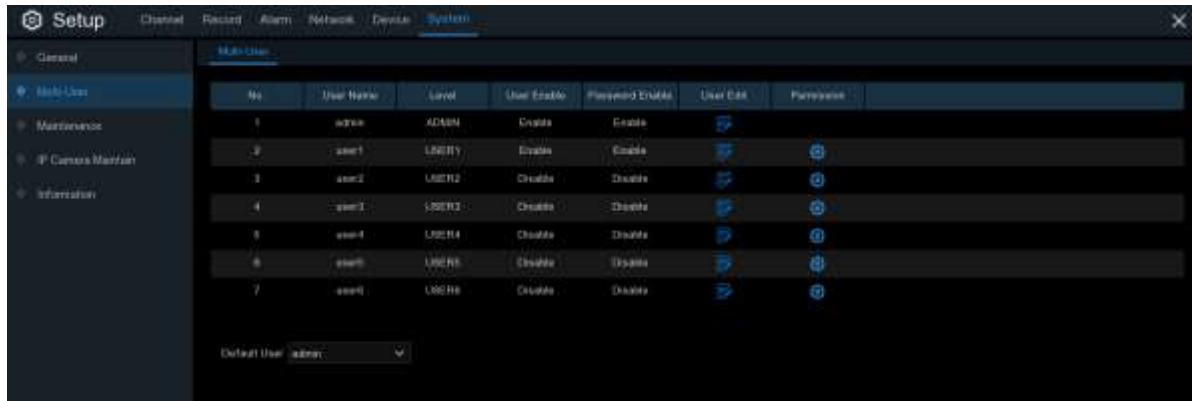

The system supports the following account types:

- **ADMIN — System Administrator:** The administrator has full control of the system, and can change both administrator and user passwords and enable/disable password protection.
- **USER — Normal User:** Users only have access to live viewing, search, playback, and other functions. You may set up multiple user accounts with varying levels of access to the system.

Note: For normal user to be able to change its password, the system administrator must grant the permission of **Subuser Password Change** first.





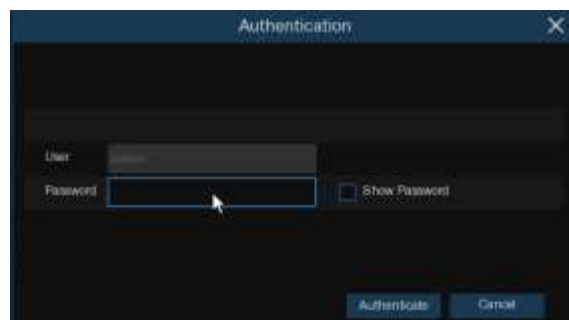
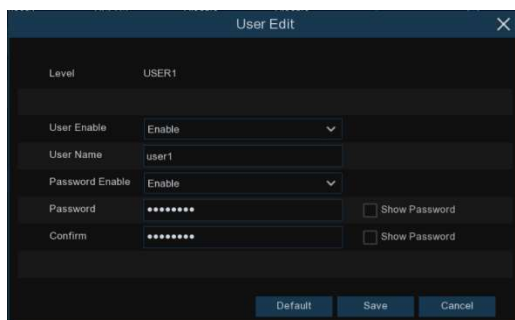







5.7.3.1 Changing Password

To change the password for the administrator or user accounts, click the User Edit icon . The password has to be a minimum of 8 characters and can contain a mixture of numbers and letters. Enter your new password again to confirm, and then click **Save** to save your new password. You will be required to input your old password to authenticate.



Password Enable: It's strongly recommended to enable the password to protect your privacy. If you want to disable the password protection, ensure your NVR is placed in a secure place.

5.7.3.2 Add New Users

No.	User Name	Level	User Enable	Password Enable	User Edit	Permission
1	admin	ADMIN	Enable	Enable		
2	user1	USER1	Enable	Enable		
3	user2	USER2	Disable	Disable		
4	user3	USER3	Disable	Disable		
5	user4	USER4	Disable	Disable		
6	user5	USER5	Disable	Disable		
7	user6	USER6	Disable	Disable		

Default User: admin

1. Select one of the user accounts that is currently disabled, click the User Edit icon .

User Edit ✕

Level: USER1

User Enable: Enable ▼

User Name: user1

Password Enable: Enable ▼

Password: •••••••• Show Password















Confirm: •••••••• Show Password

Default Save Cancel

2. Select **Enable** from the drop-down next to **User Enable**.
3. Click the field next to **User Name** to change the user name for the account.
4. Select **Enable** from the drop-down next to **Password Enable**.
5. Click the field next to **Password** to enter the desired password.
6. Click the field next to **Confirm** to reenter the password.
7. Click **Save**. You will be required to input your Admin password to authenticate.

5.7.3.3 Setting User Permissions

The administrator account is the only account that has full control of all system functions. You can enable or disable access to certain menus and functions of each user account.

No.	User Name	Level	User Enable	Password Enable	User Edit	Permission
1	admin	ADMIN	Enable	Enable		
2	user1	USER1	Enable	Enable		
3	user2	USER2	Disable	Disable		
4	user3	USER3	Disable	Disable		
5	user4	USER4	Disable	Disable		
6	user5	USER5	Disable	Disable		
7	user6	USER6	Disable	Disable		

Default User:

1. Click the edit icon  under Permission tab.

User Permission [X]

User Name: user1

<input checked="" type="checkbox"/> Log Search	<input checked="" type="checkbox"/> Parameter	<input checked="" type="checkbox"/> Maintain	<input checked="" type="checkbox"/> Manual Record
<input checked="" type="checkbox"/> Disk	<input checked="" type="checkbox"/> Remote Login	<input checked="" type="checkbox"/> SEQ Control	<input checked="" type="checkbox"/> Manual Capture

Backup

Analog Channels: 1 2 3 4 5 6 7 8

IP Camera: 1 2 3 4 5 6 7 8 9 10 11 12

Live

Analog Channels: 1 2 3 4 5 6 7 8

IP Camera: 1 2 3 4 5 6 7 8 9 10 11 12

Playback

Analog Channels: 1 2 3 4 5 6 7 8

IP Camera: 1 2 3 4 5 6 7 8 9 10 11 12

PTZ

Analog Channels: 1 2 3 4 5 6 7 8

IP Camera: 1 2 3 4 5 6 7 8 9 10 11 12

2. Check the boxes next to any system menus or capabilities you would like the user to access. Click **All** to check all boxes. Click **Clear** to check none of the boxes.
3. Click **Save** to save your modifications.

5.7.4 Maintenance

In this section, you will be able to search & view the system log, load default settings, upgrade the system, export & import system parameters and manager system auto reboot.

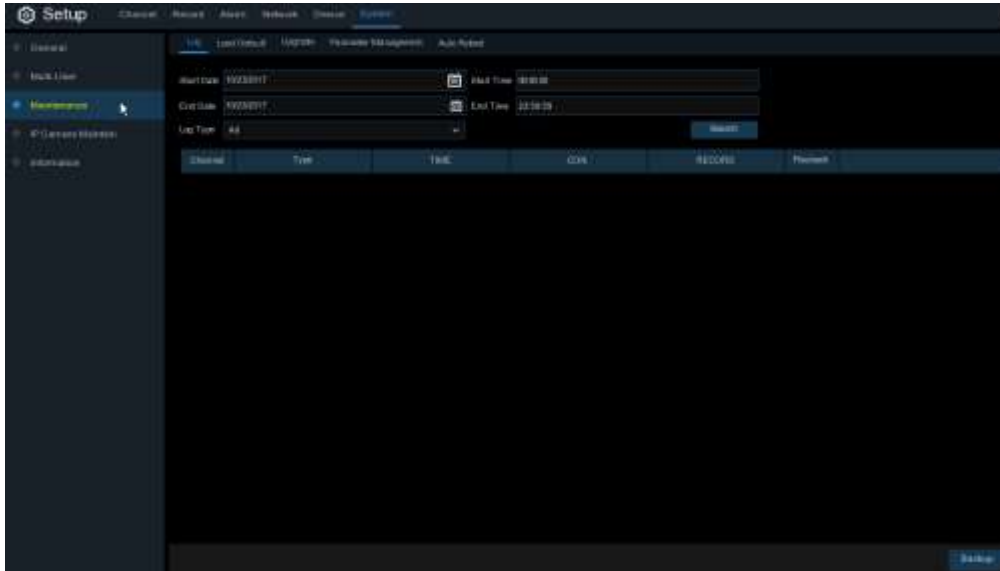

5.7.4.1 Log

The system log shows you important system events, such as motion alarms and system warnings. You can easily create a backup file of the system log for a set time period to a USB flash drive.

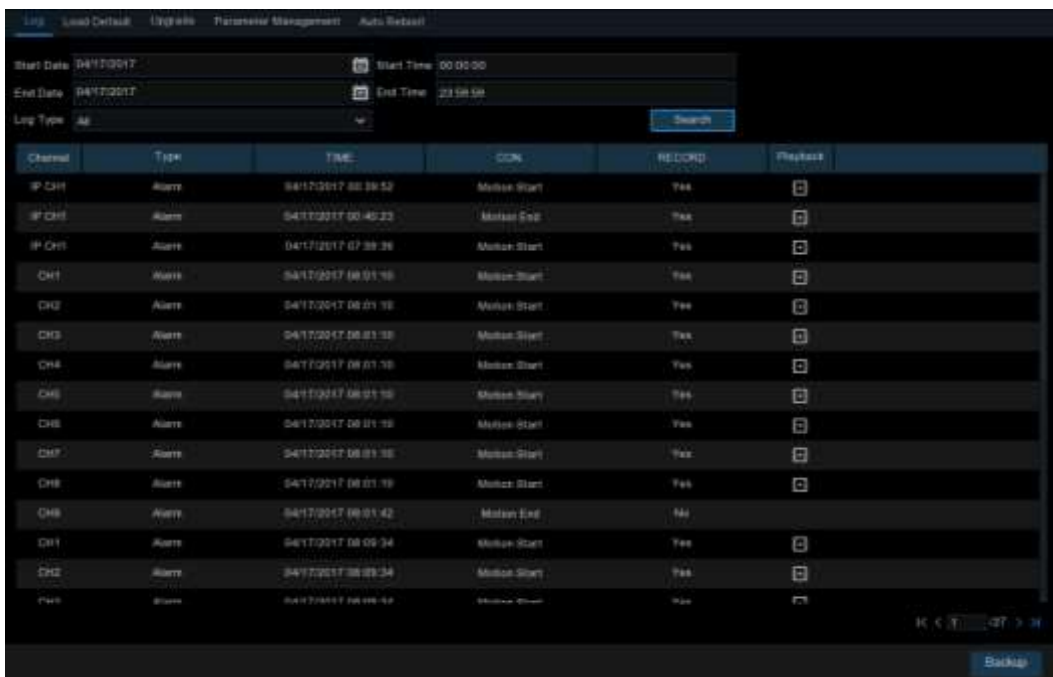

Log Searching and Backing Up:

1. Click the field next to **Start Date & Start Time** to choose the starting date & time for your search from the on-screen calendar.

2. Click the field next to **End Date & End Time** to choose the end date & time for your search from the on-screen calendar.
3. Select the type of events you would like to search for from the dropdown next to **Log Type**, or select **All** to see the entire system log for the selected time period.
4. Click **Search**.
5. Browse system log events from your search period:
 - Video events can be played back instantly by clicking in the **Playback** column. Right-click to return to your search results.
 - Use the **◀ < / > ▶** buttons in the bottom-right corner of the menu to move between pages of system log events.
6. Click **Backup** to create a backup of the system log for your search period. Make sure your flash derive has been connected to the NVR's USB port.
7. The backup drive menu appears. Navigate to the folder you want the backup file to be saved in, then click **OK** to begin.

5.7.4.2 Load Default

Reset the NVR settings to its out-of-box state. You can choose to reset all settings at once, or just settings on specific menus. Restoring default settings will not delete recordings and snapshots saved to the hard drive.

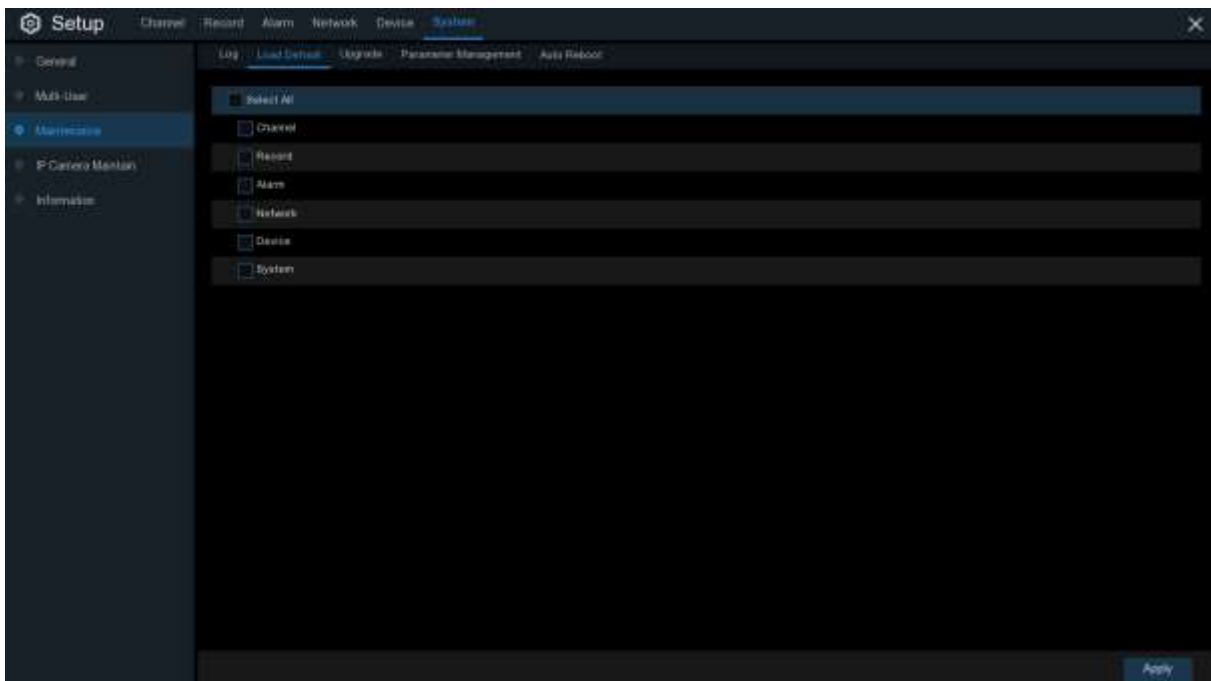

Check the items you want restore, or check **Select All** to choose all items. Click **Apply** to load default settings of your chosen items.

5.7.4.3 Upgrade

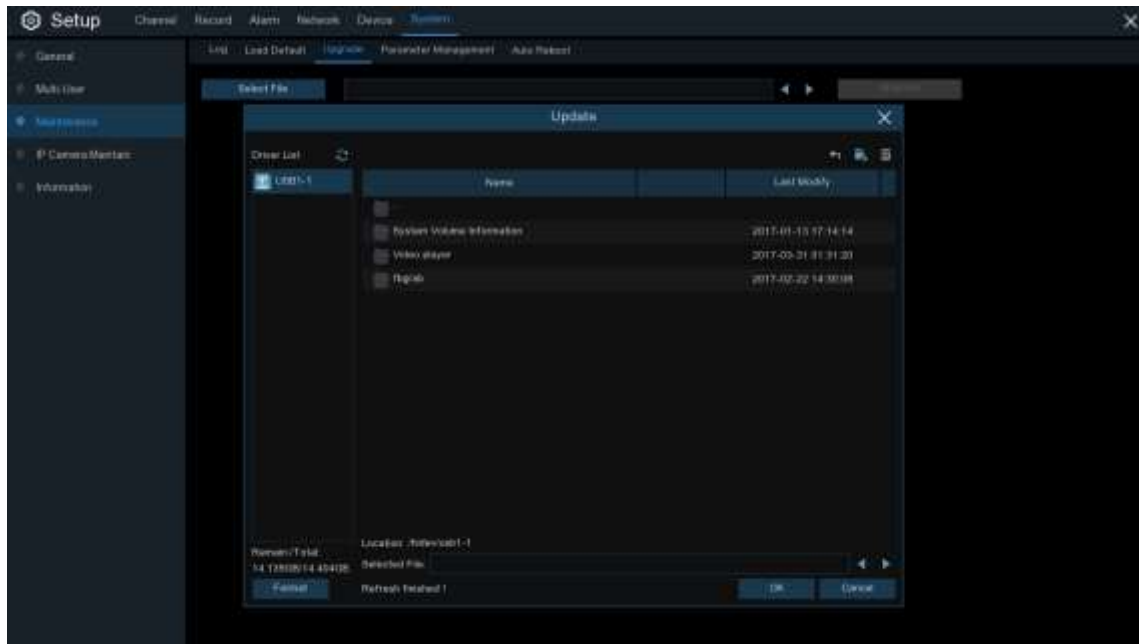

1. Copy the firmware file (.sw file) to your USB drive, and insert the USB flash drive into the NVR's USB port.
2. Click Select File button to choose the firmware file in your USB flash drive, then Click **OK**.
3. Click **Upgrade** button to start system upgrade. The system upgrade will last around 5-10 minutes, do NOT power off the NVR or remove the USB from NVR during firmware upgrade.

Note: You can optionally upgrade the firmware using **UVS Device Utility**. See [Chapter 5 Upgrading Firmware in UA-SNVR Quick Start Guide](#).

5.7.4.4 Parameter Management

You can export the main menu settings you have configured to a USB flash drive, or import an exported setting file from USB flash drive to the NVR.

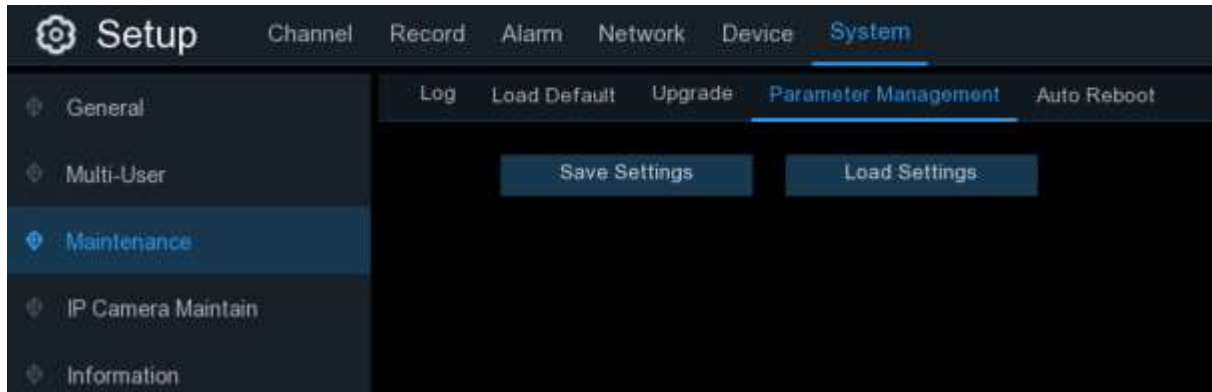

Save Settings: Click to save the NVR current system settings to the USB device. You will be required to input the Admin password to authenticate.

Load Settings: Once you have created a system settings export, you can import the settings on another NVR. Click **Load Settings** button to navigate to the system settings file you want to import from your USB flash driver. You will be required to input the Admin password to authenticate.

5.7.4.5 Auto Reboot

This menu allows the system to auto reboot the NVR regularly. It is recommended to leave this function enabled, as it maintains the operational integrity of your NVR.

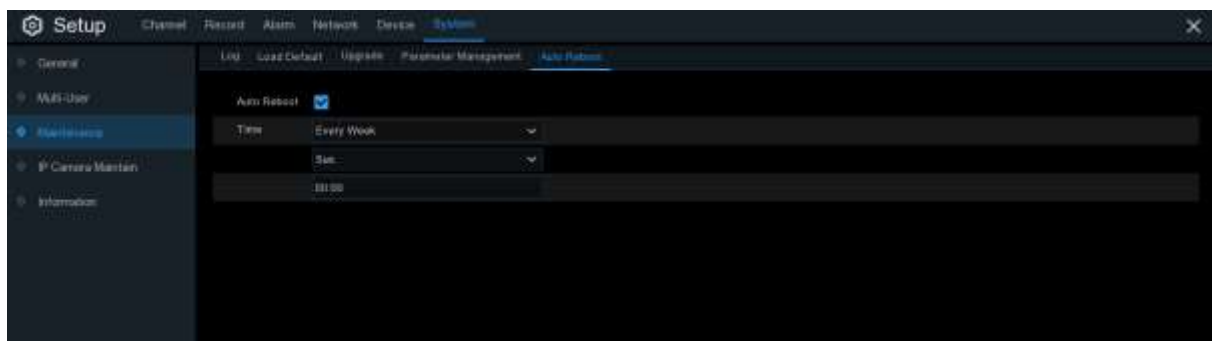

Auto Reboot: Check to enable.

Time: You can set the NVR to reboot by day, week or month.

5.7.5 IP Camera Maintain

This menu allows you to upgrade the IP camera's firmware and restore default settings of IP camera.

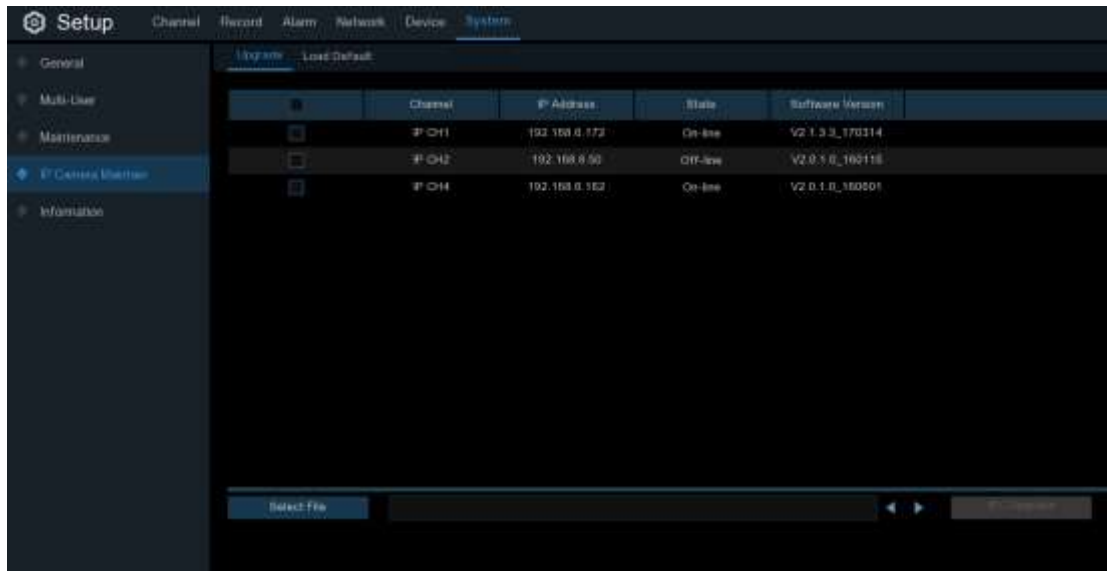

5.7.5.1 Upgrade IP Camera

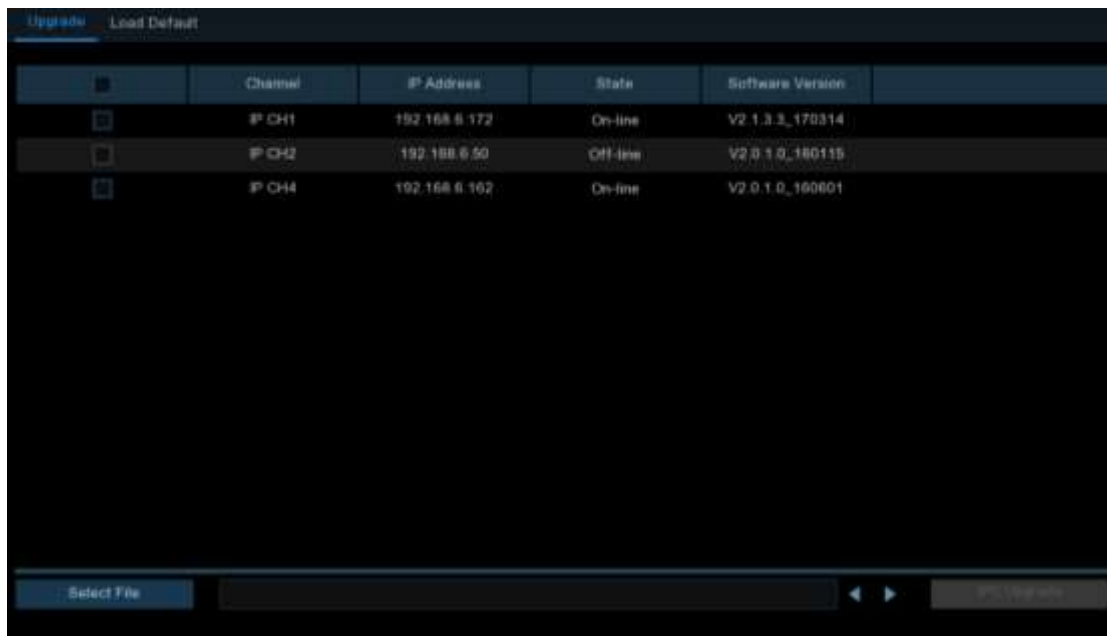

1. Choose one of the IP cameras you want to upgrade firmware.
2. Click **Select File** select the update file from your USB flash drive, then click **OK**.
3. Click IPC Upgrade button to start upgrading. You will be required to input the Admin password to authenticate. Do NOT power off the NVR and IP camera or remove the USB during the upgrading.

5.7.5.2 Load Default Settings for IP Camera

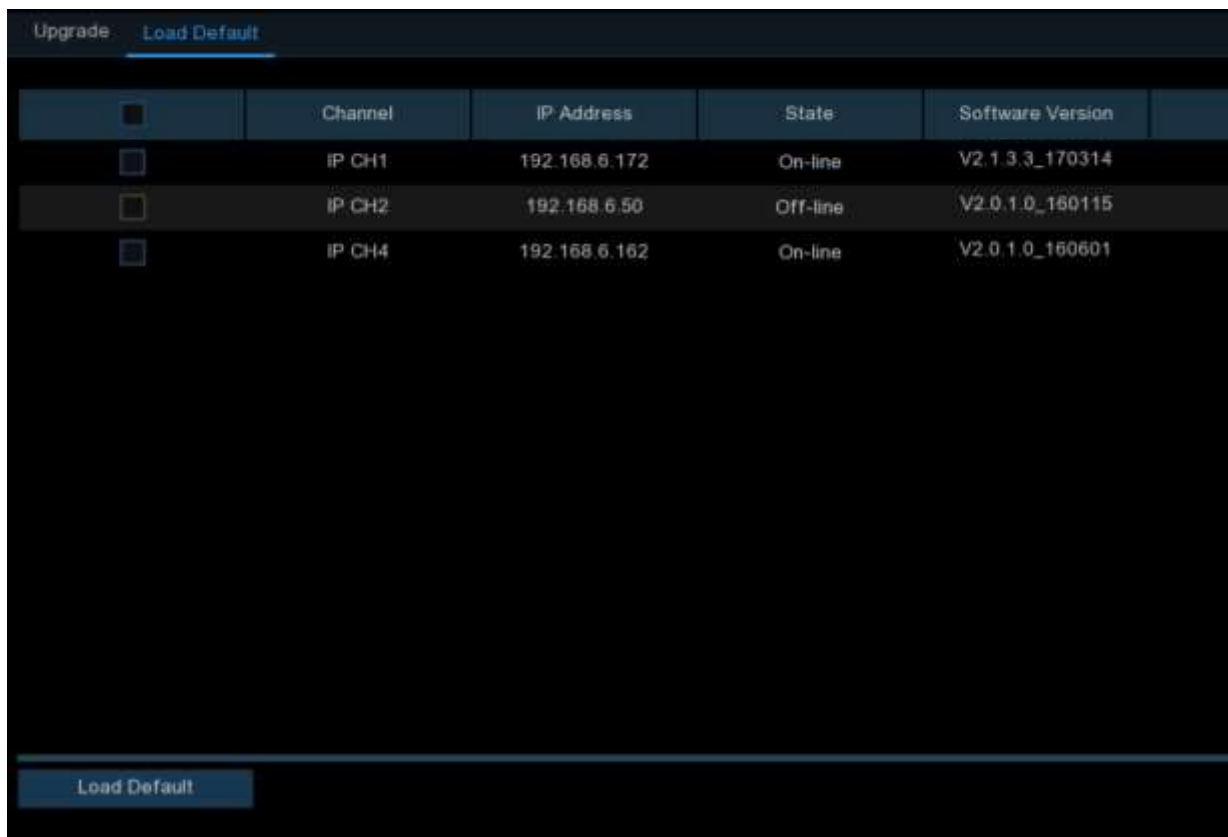

1. Choose the IP cameras you want to restore.
2. Click **Load Default** to restore settings. You will be required to input the Admin password to authenticate.

5.7.6 System Information

This menu allows you to view the system information, channel information, record information & network status.

5.7.6.1 Information

View system information such as device ID, device model name, IP address, MAC address, firmware version and more.

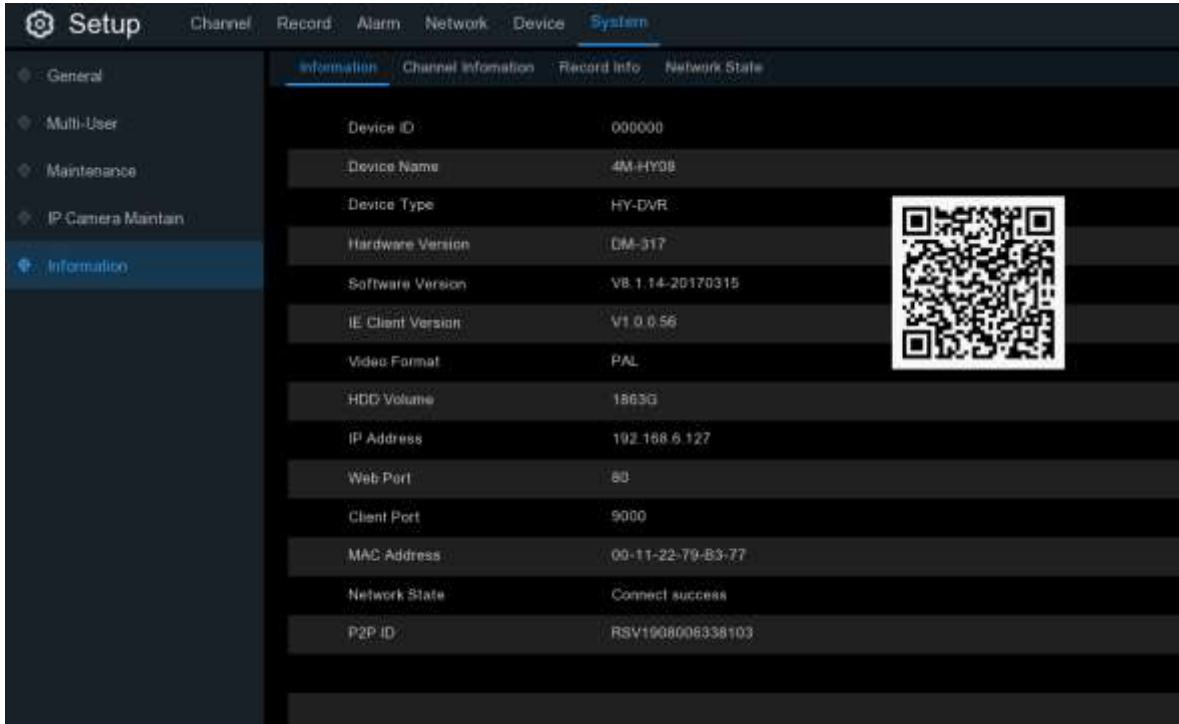

If your NVR supports P2P function, you will find the P2P ID & P2P QR code in the information page. You can scan this QR code with the mobile app to remote view the NVR.

Note: The P2P function is only supported by GV-Eye V2.9.0 or later.

5.7.6.2 Channel Information

Channel	Alias	State	Mainstream	Substream	Motion Detection	Privacy Zone
CH17	CH17	On-line	704x 480, 30Fps, 32Kbps	704x 480, 0Fps, 8Kbps	Support	Support
CH18	CH18	On-line	704x 480, 30Fps, 32Kbps	704x 480, 0Fps, 8Kbps	Support	Support
CH19	CH19	On-line	704x 480, 30Fps, 32Kbps	704x 480, 0Fps, 8Kbps	Support	Support
CH20	CH20	On-line	704x 480, 30Fps, 32Kbps	704x 480, 0Fps, 8Kbps	Support	Support
CH21	CH21	On-line	704x 480, 30Fps, 32Kbps	704x 480, 0Fps, 8Kbps	Support	Support
CH22	CH22	On-line	704x 480, 30Fps, 32Kbps	704x 480, 0Fps, 8Kbps	Support	Support

View channel information for each connected camera such as alias, mainstream and substream recording specifications, motion detection status & privacy zone.

5.7.6.3 Record Information

Channel	Record State	Record Switch	Stream Type	Resolution	FPS	Bitrate
CH17	OFF	Enable				
CH18	OFF	Enable				
CH19	OFF	Enable				

View recording information for each connected camera such as bitrate, stream type, recording resolution and frame rate (FPS).

5.7.6.4 Network State

Attribute	Value
WLAN	
IP Address	192.168.1.100
Subnet Mask	255.255.255.0
Gateway	192.168.1.1
MAC Address	88-72-29-86-A3-23
DHCP	Enable
Internal Interface	
Internal Interface	Connected
IP Address	10.10.25.100
Subnet Mask	255.255.0.0
DNS1	192.168.1.1
DNS2	8.8.8.8
PPPoE	Disable
Port	
Web Port	80
Client Port	9000
RTSP Port	554
UPNP	Disable
Total Band Width:	320Mbps
Used Band Width:	5.013Mbps

View network information.

Total Band Width: It shows the NVR's total input band width for IP cameras.

Used Band Width: It shows the used band width of IP cameras.

5.8 AI Scenario

AI Scenario function provides AI applications for different specific scenarios. Click the submenu title in the main setup page to get into the individual function setup page.

Note: The AI Scenario functions are only applicable to **UA-SNVR1620-P** and **UA-SNVR3420-N** when connected to the following UA-IP cameras with specified firmware versions:

- UA-B580F3 (V1.01 or later)
- UA-R560D2 (V1.01 or later)
- UA-R580F2 (V1.01 or later)
- UA-R800F2 (V1.01 or later)

These settings are not available on the NVR's Web interfaces.

5.8.1 Cross Counting

This is an AI application based on cross counting function, which helps to control the attendance number of customers/visitors/vehicles in public places, like restaurants, parks, zoos, theaters, museums, car parks, etc.



1. Navigation bar on the left side:

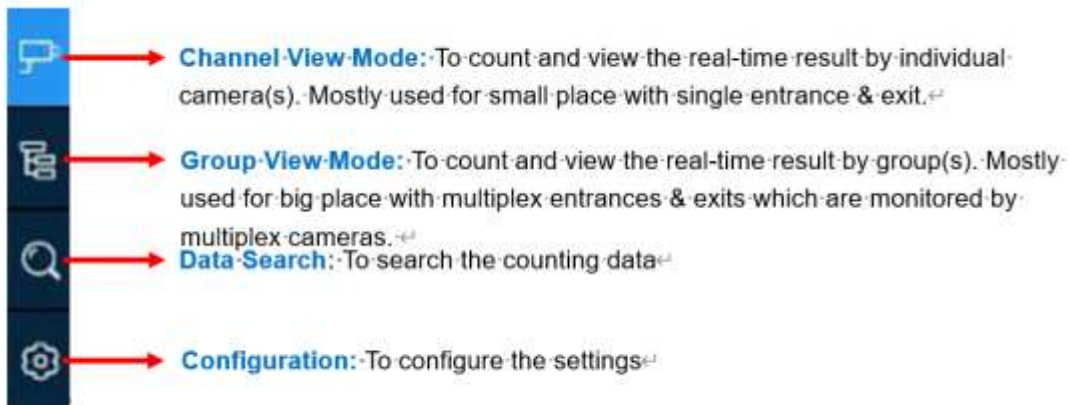

2. Real-time data display:



Available: Remaining allowed attendance number

Inside: Current attendance number inside the control area

Enter: Recorded number of total entrants

Exit: Recorded number of total leaving attendance.

3. Real-time counting data display:



 Screen display layout of 4/6/9 channels.

 To show or hide the real-time data display.

 Clear counting data for the selected channel

 Clear counting data for all channels

4. Real-time counting data information bar



This bar will display the real-time counting data for the selected channel.

Available: Remaining allowed attendance number

Inside: Current attendance number inside the control area

Enter: Recorded number of the total entrants

Exit: Recorded number of the total leaving attendance.



If the available number is more than 0, the figure will be in green color.



If the available number is 0, the figure will be in red color.

5. Full Screen Button:

Click the full screen icon  to display the real-time counting data for the selected channel(s) or group(s).

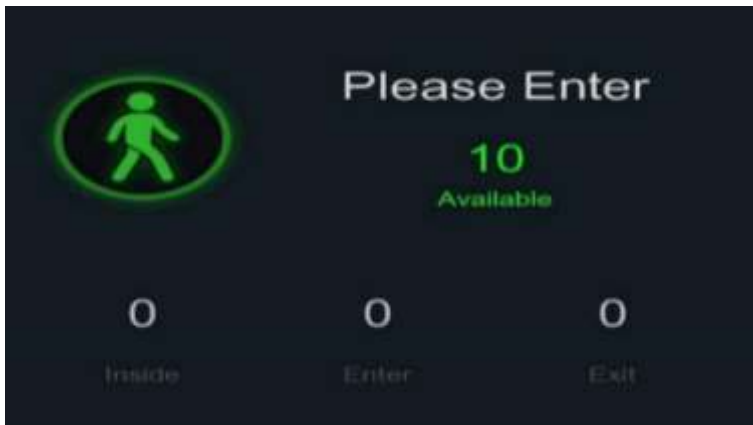

If you have enabled the **Advertise Mode**, your advertising pictures will be displayed with the real-time counting data together in the full screen mode. Learn more for **Advertise Mode** on [5.8.1.3 Advertise Mode](#).

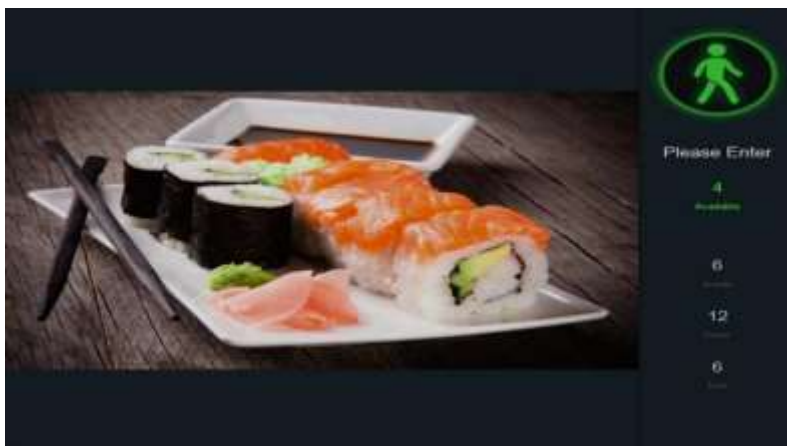

Right click your mouse to exit the full screen mode.

6. Statistic data chart:



Channel	Type	12:00	13:00	14:00	15:00	16:00	17:00
CH2	Enter	5	11	12	1	0	0
	Exit	9	11	12	1	0	0
	Inside	0	0	0	0	0	0
CH3	Enter	-	-	-	-	-	-
	Exit	-	-	-	-	-	-
	Inside	-	-	-	-	-	-
CH5	Enter	47	27	36	8	0	13
	Exit	26	13	16	3	0	9
	Inside	100	114	134	139	139	143
CH6	Enter	0	0	0	0	0	0
	Exit	0	0	0	0	0	0
	Inside	0	0	0	0	0	0

The all-day counting statistical data of all activated channels will be displayed below the real-time counting data information. Use the mouse wheel to move the timeline toward left or right.

5.8.1.1 Channel View Setup

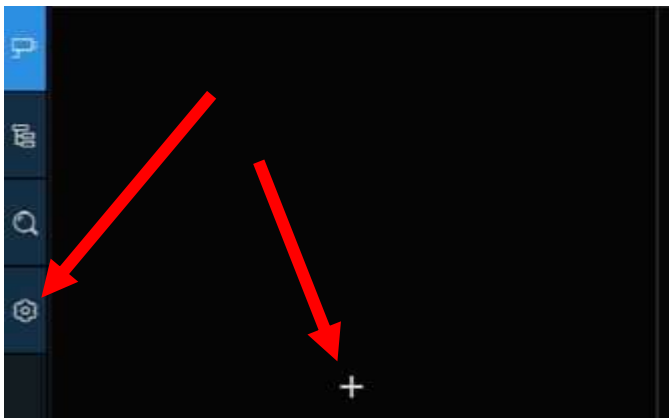
1. Click the add icon **+** or setup icon  to get to the configuration page.



2. Enable the channel(s) you want to realize the counting function in the **Channel** list. The Setup & Alarm icon  will be in blue color if the camera in that channel supports AI function; on the contrary, if the camera doesn't support AI function, the icon  will be in grey color.
3. Set the **Capacity** number for each channel, which is the maximum limitation of the attendance.

4. Click one of the **Setup** icons  to configure the detection conditions.



Switch: Activate or inactivate the detection.

Type: Choose the detection target objects. **Motion** will detect all moving objects, **Person** will detect human beings only, and **Vehicle** will detect vehicles only.

Sensitivity: Set the sensitivity level. Level 1 the lowest sensitivity level while level 4 is the highest sensitivity level.

Rule Type:

A→B: If a target object is detected moving from side A to side B, the system will count 1 to enter number; if a target object is detected moving from side B to side A, the system will count 1 to exit number.

B→A: If a target object is detected moving from side B to side A, the system will count 1 to enter number; if a target object is detected moving from side A to side B, the system will count 1 to exit number.

Start Time: Set the detection start time.

End Time: Set the detection end time.

Dynamic Marking: If you enable this option, the border of the detection zone will be displayed in both live view images and recording files.

Configuration Steps:

1. Activate the **Switch**.
2. Choose the detection target type.
3. To set the **Sensitivity**.
4. Choose a **Rule Type**.
5. Set the **Start Time** and **End Time**.
6. Use your mouse to click 2 points on the camera picture to draw a virtual line.
7. Click **Save** to save your settings.

8. If you want to modify the position or length of the line, click the red box in the line, the color of the line will be changed to red color. Click and hold the left button of your mouse to move the line, or drag the terminals to modify the length or position of the line.
9. If you want to remove one of the lines from the camera picture, click the red box in the line and then click **Remove** button.
10. Right click your mouse to exit the setup page.
11. Repeat step 3 to finish the configuration for all channels you want to activate the function.
12. Click one of the **Alarm** icons  to configure the alarm actions when the Available number is 0.

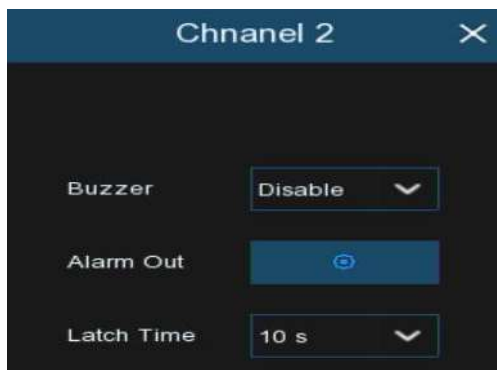

Buzzer: Set the buzzer duration in seconds when the Available number is 0.

Alarm Out: If your NVR supports to connect to external alarm device, you can set to emit an alarm tone.

Latch Time: To configure the external alarm time when the Available number is 0.

Right click your mouse to exit the alarm setup page, and then click **Save** button to save the settings.







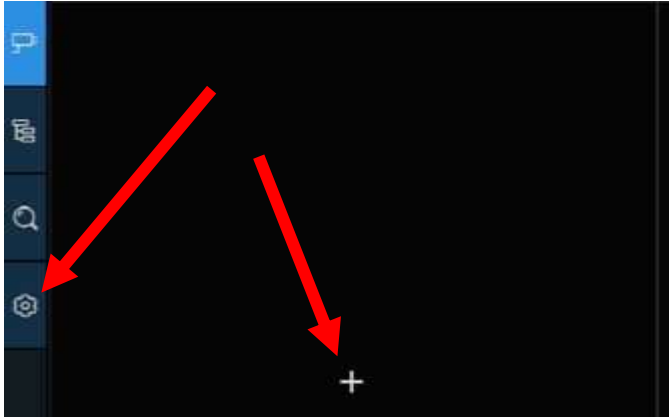



13. Click the **Channel View** icon  to view the live images & counting data of all activated channels.

5.8.1.2 Group View Setup

1. Click the add icon **+** or setup icon  to get to the configuration page.



2. Click the **Add IP Camera** icon  to add channel(s) to the group. Max. 8 groups can be set, but each one channel can be added to 1 group only. If a channel is enabled in the Channel View mode, it will be not allowed to add to any group.

Group	Add IP Camera	Enable	Capacity	Start Time	End Time	Type	Alarm
Group 1		<input checked="" type="checkbox"/>	50	00:00:00	23:59:59	Person	
Group 2		<input checked="" type="checkbox"/>	10	00:00:00	23:59:59	Person	
Group 3		<input checked="" type="checkbox"/>	10	00:00:00	23:59:59	Person	
Group 4		<input checked="" type="checkbox"/>	10	00:00:00	23:59:59	Person	
Group 5		<input type="checkbox"/>	10	00:00:00	23:59:59	Person	
Group 6		<input type="checkbox"/>	10	00:00:00	23:59:59	Person	
Group 7		<input type="checkbox"/>	10	00:00:00	23:59:59	Person	
Group 8		<input type="checkbox"/>	10	00:00:00	23:59:59	Person	

3. Check the Enable box to activate the group.
4. Set the **Capacity** number, **Start Time**, **End Time** of each group.
5. Choose the detection target **Type** from **Person**, **Vehicle** and **Motion**.
6. Click one of the **Alarm** icons  to configure the alarm actions when the Available number is 0.

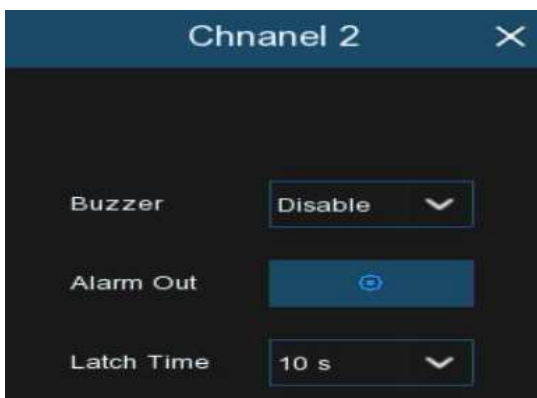

Buzzer: Set the buzzer duration in seconds when the Available number is 0.

Alarm Out: If your NVR support to connect to external alarm device, you can set to emit an alarm tone.

Latch Time: To configure the external alarm time when the Available number is 0.

7. Click the close icon or right click your mouse to go back to previous configuration page, and then click **Apply** button to save the settings.
8. Click the **Group View** icon to view the live images & counting data of all activated groups.

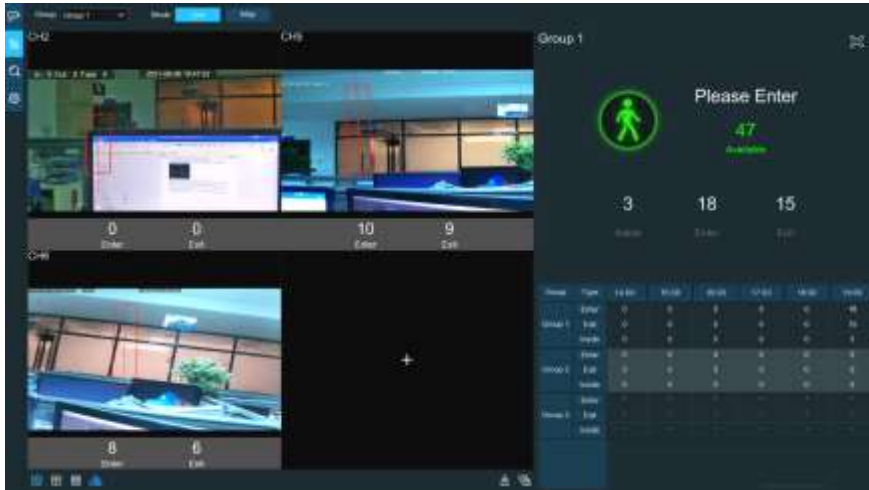



9. You can choose which group you want to view the real-time live images and counting data.

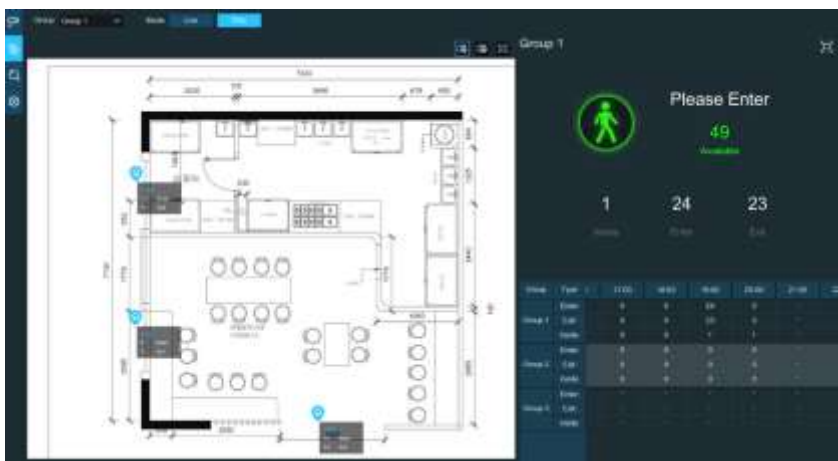

10. Furthermore, it supports to display the counting data in Map mode. Click the **Map** button to configure the settings.



11. Click the icon to add a map image from your USB memory.

- Click icon  to adjust the site of the IP cameras. Click and hold the channel icon and move one by one to adjust the position of your IP cameras on the map. You can click  icon to display the map in full screen.

5.8.1.3 Advertise Mode



The system supports to demonstrate your advertising pictures with the Cross Counting functions.

- Click the **Configuration** icon  to in the **Navigation bar** to get to the configuration page.

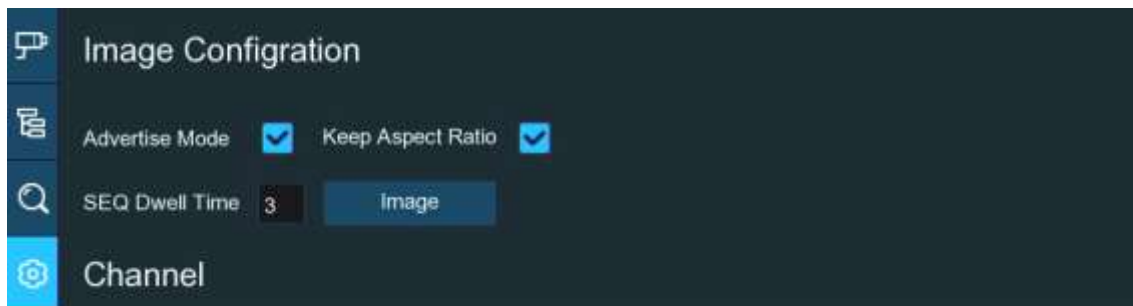

- Check the Advertise mode in the



- Click **Image** button to load advising pictures from your USB memory. It supports to add maximum 16 pictures with jpg, png and bmp format, and the maximum resolution should be no more than 2560 x 1600. Click the add icon  to add new picture(s) and click delete icon  to delete the added picture one by one. Click the close icon  or right click your mouse to go back to previous configuration page.



4. Check the **Keep Aspect Ratio** box if you want to display the images with their original aspect ratio. Uncheck the box if you want the pictures to be stretched and displayed full screen.



5. Set the **SEQ Dwell Time** in seconds which will decide how long each picture will stay in the screen.
6. Click **Apply** button to save your settings.
7. Go back to Channel View mode or Group View mode, click the full screen button  on the right upper corner to display your advertising pictures and the real-time counting data for the selected channel(s) or group(s).



5.8.1.4 Search Counting Data

1. Click the **Search** icon to search the counting data.



2. It allows you to search separately for Channels and Groups. Choose the channel(s) or group(s) you want to search, set the search duration by day, by week, by month or by year and choose the target type you want to search. Click the search icon , the result will be displayed on the right side of the window.



5.8.2 Face Attendance

Face Attendance is an AI application based on Face Recognition results. You're able to view and check the real-time statistical data of attendance management visually.



1. Custom title.
2. Overall attendance statistical data of all selected groups.
3. Individual attendance statistical data of each selected group.
 - The total number of people who need to check attendance
 - The number of people who have checked attendance already
 - The number of people who haven't checked attendance.
4. Live view screen: To display the live camera images. Click the screen split icons , , to change the display layout.
5. Push notifications of latest persons who have checked the attendance, including the Name/ID of the person, captured face image, group, clock in time, and clock out time. Normal clock in & clock out time will be displayed in green color. Abnormal clock in & clock out time will be displayed in red color. Click the screen split icons , , to change the display layout.
6. Click search icon to search the face attendance data. Check more on [6.1.6.5 Face Attendance](#).

Click Setting icon  to configure the face attendance settings.

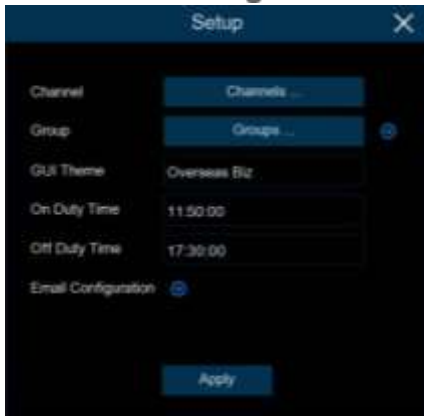

Channels: To choose the channels for face detection

Group: To choose the attendance people group. If you want to edit the group database, click the  icon to edit. Check more on [5.4.2.2 Database Management](#).

GUI Theme: To give a custom title to the face attendance.

On Duty Time: To set the on-duty time.

Off Duty Time: To set the off-duty time.

Email Configuration: To send the attendance statistical data by email. click the  icon to edit the email configuration.

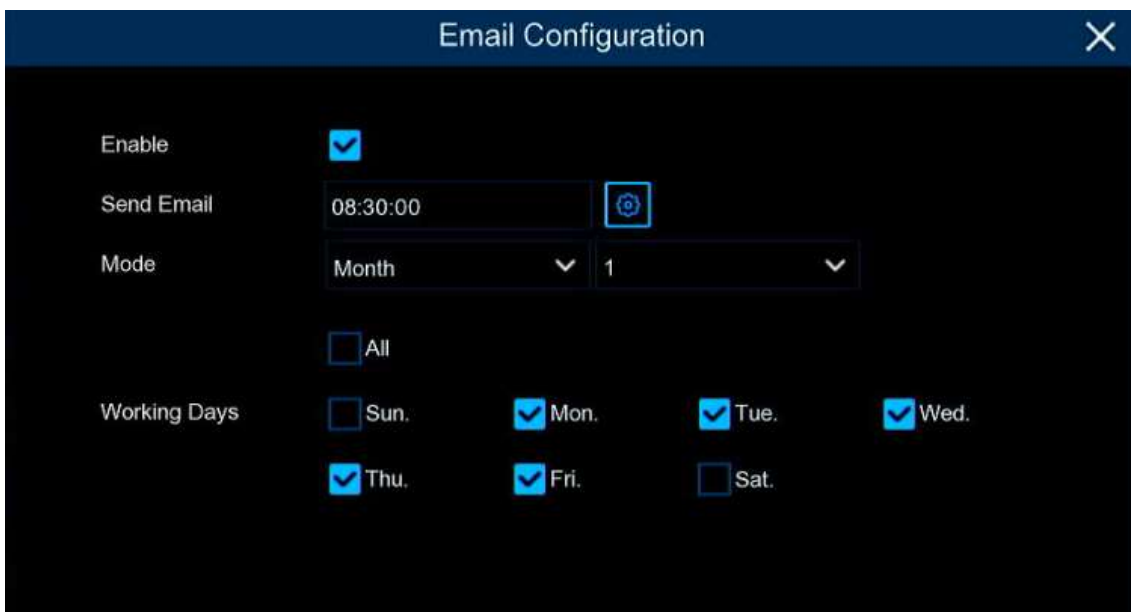

Enable: Check the box if you want to send the attendance statistical data by email.

Send Email: Set the preset time for sending the email.

Mode: Choose to send the email once in every **Day**, every **Week**, or every **Month**.

Day: Send the attendance statistical data of previous day once a day.

Week: Send the attendance statistical data of last 7 days once a week.

Month: Send the attendance statistical data of last month once a month.

Working Days: To select the working days. It will affect the attendance statistical data.

Click the setting  icon to configure your email configuration. Check more on [5.4.3.1 Email Configuration](#).

Chapter 6 Search, Playback & Backup

The Search function gives you the ability to search for and play previously recorded videos as well as snapshots that are stored on your NVR's hard drive. You have the choice of playing video that matches your recording schedule, manual recordings or motion events only. The Backup function gives you the ability to save important events (both video and snapshots) to a USB flash drive.

Note: To play the video clips saved locally on your PC, install and launch one of the following players **before** locating the recordings. Wait for 3 ~ 30 seconds before the video starts to play.

1. [USA Vision Player](#)
2. [VLC Media Player](#)
3. [KM Player](#)

6.1 Using Search Function

Click  **Search** button in the Start Menu to enter search section.

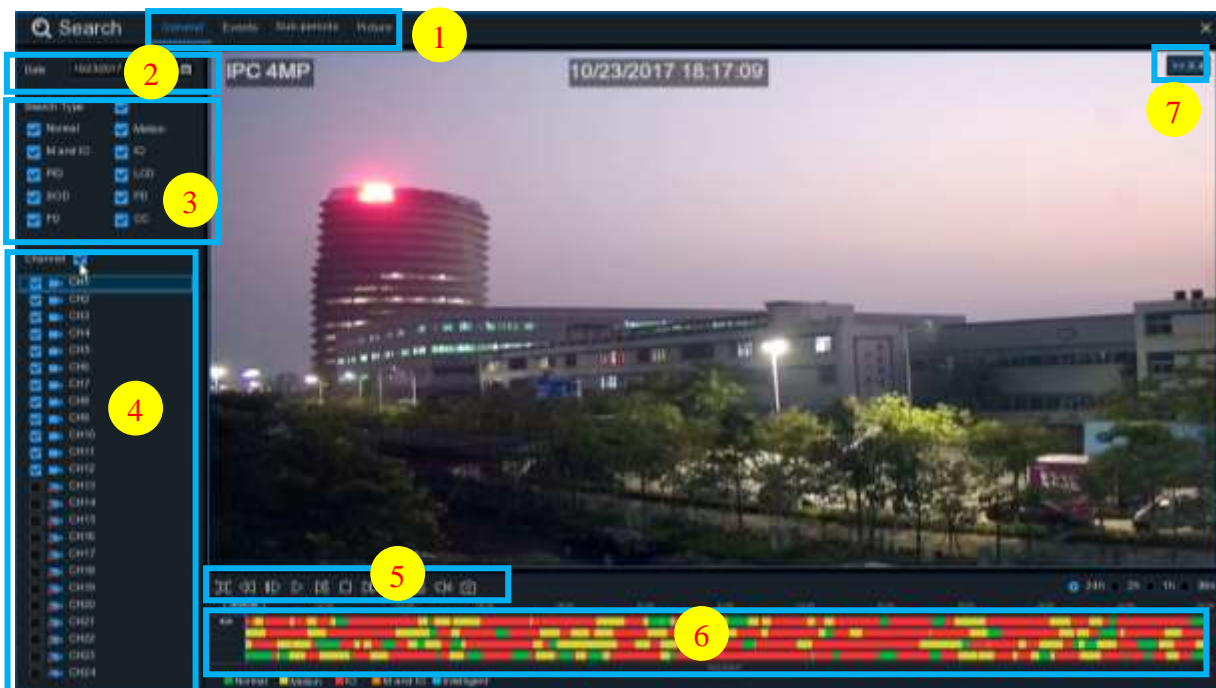



1. **Search Options:** the system provides various search & playback methods: General, Events, Sub-periods, Smart & Pictures
2. **Search Date:** search by a date to play back.
3. **Search Type:** the system provides different search types to narrow your search.
4. **Channel Selection:** to choose the channels you want to search & play.

5. **Video Playback Controls:** to control the video playback.



 Enlarge the video playback to full screen

 Rewind, x2, x4, x8 and x16

 Slow Play, 1/2, 1/4 and 1/8, 1/16 speed

 Play

 Pause

 Play frame by frame. Click once to play a frame of the video

 Stop



 Fast Forward, x2, x4, x8 and x16

 Digital Zoom: Click to zoom in then click-and-drag on a camera image during playback to zoom in on the selected area. Right-click to return to regular playback.

 Video Clip. Quickly save a section of video to a USB flash drive. View more on [6.1.1.1 Video Clip Backup](#)

 Save Video Clip.

 Volume Control: scroll the slider bar to increase or decrease volume.

 Snapshots: to capture a snapshot image to your USB flash drive. If the video playback is in split-screen view, move the mouse cursor to the channel you want to capture, and then click the  icon to save the snapshot.

6. **Timeline:** Continuous recordings are shown with colored bars to represent different types of recording (legend shown in the bottom-right corner of the display). Use the timeframe options

( 24h  2h  1h  30m) to view a smaller or larger time period.

Different types of recording shown in different colors:



Continuous Recording in **Green** color;

Motion Recording in **Yellow** color;

I/O Recording in **Red** color;

Motion & I/O Recording in **Orange** color;





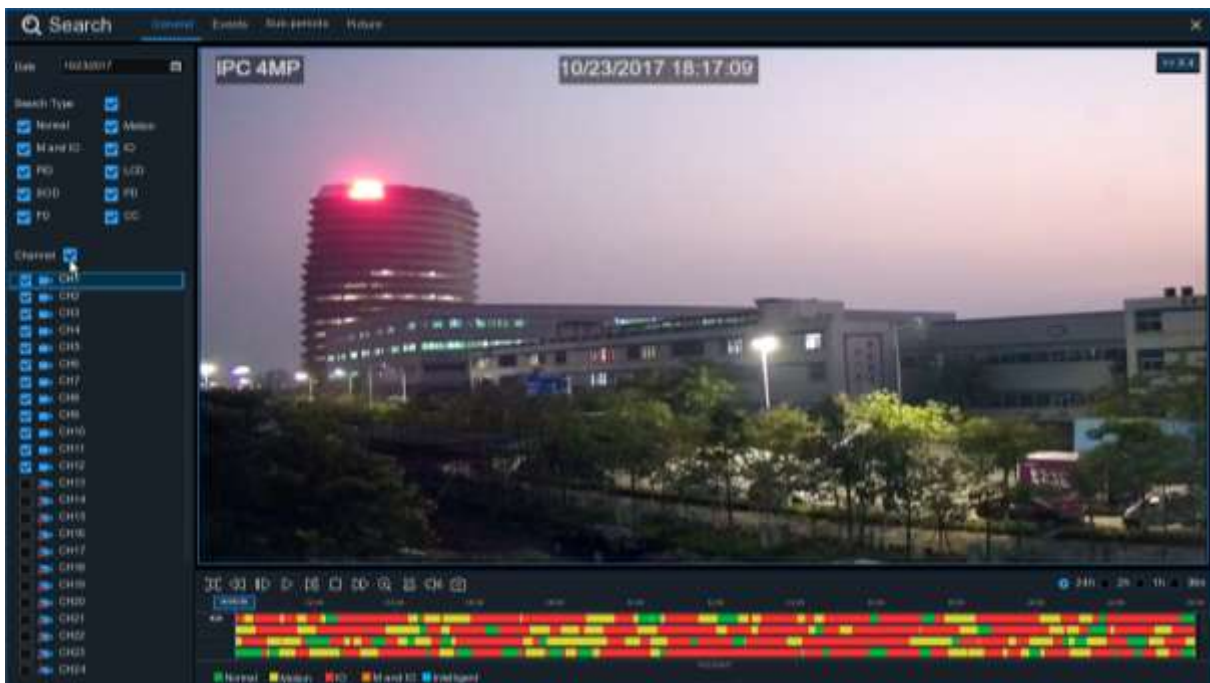

AI / Intelligent Recording in **Blue** color;

7. **Playback Status:** display the video play status.

6.1.1 Search & Play Video in General





This menu gives an option to search & play recording for a selected date.

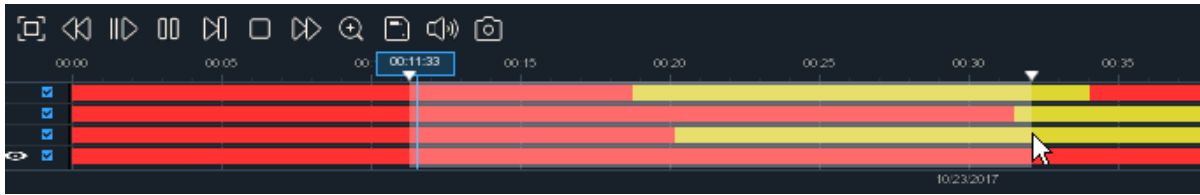

1. Select a date to search for video recording from the calendar.
2. Choose a search type.
3. Check channels you would like to search, or check **Channel** to search all connected channels.
4. The search result will display on the timeline from 00:00 to 24:00.
5. Click  button to start playback.
6. Control the playback with buttons on **Video Playback Controls**.
7. Use the timeframe options ( 24h  2h  1h  30m) to view a smaller or larger time period.
8. If you want to quickly save a section of video during playing back to a USB flash drive, use the  **Video Clip** backup function.

6.1.1.1 Video Clip Backup



1. Insert your USB flash drive to the NVR.
2. Start a video recording playback.
3. Click  icon.
4. Check the channel(s) you want to make a video clip backup.
5. Move the mouse cursor to the timeline where you want to start the video clip.
6. Press and hold the left button of your mouse, and drag the drag the cursor to the timeline where you want to end the video clip.
7. The  icon has been changed to  icon, click  to save the video clip.
8. Select a file type for your backup files, click **Save** button to save the video clips. Make sure your USB driver has enough space to save the video clips.

The backup drive menu appears. Navigate to the folder you want the backup files to save in.

9. Click **OK** to begin. The progress bar at the bottom of the window shows you the progress of the backup.

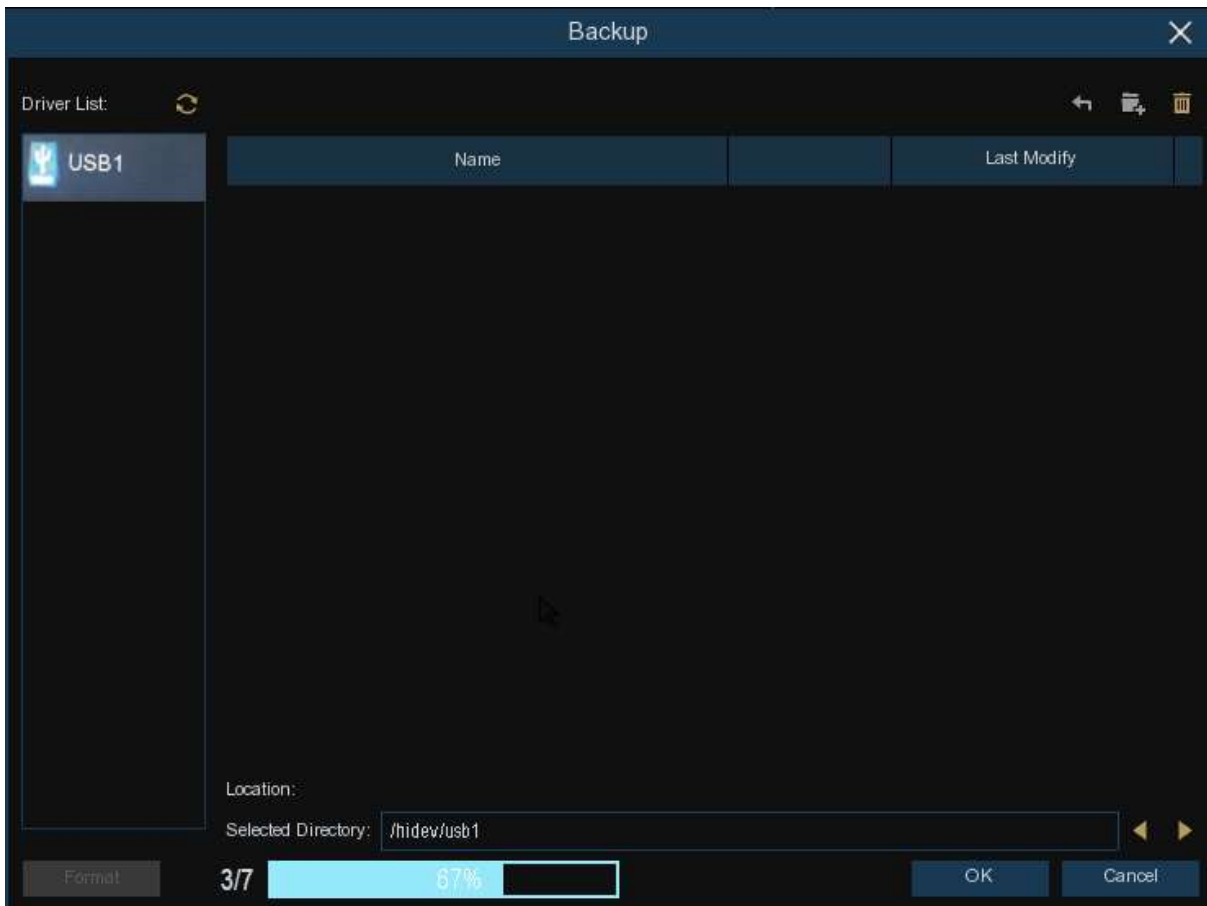

6.1.2 Event Search, Playback & Backup

Event search lets you view a list of video recordings with the channel, start and end time, and recording type conveniently summarized. You can also quickly back up events to a USB flash drive.



To search, play & back up for events:

1. Choose the date & time you want to search.
2. Check the recording types you want to search, or check **Search Type** to choose all.
3. Choose the channels you want to search, or check **Channel** to choose all channels.
4. Click icon to start search.
5. Events fitting your search criteria are displayed in list form. You can double click the left button of your mouse upon one of the events to play the video immediately.
6. Click icons in the bottom-right corner of the menu to browse between pages of events, or input the page you want to browse.
7. You can switch the view of list form in by clicking below icons which is show at the right bottom corner of the screen:

Thumbnails view. You can view the snapshots of the events.

List view. The events will be displayed in list.

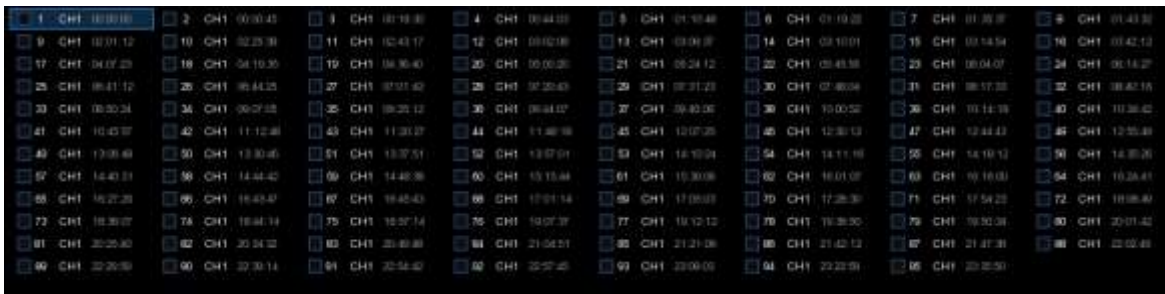

Detailed view. You can view the details of the events.

#	Channel	Type	Date	Start Time	End Time	Size	Playback	Lock
1	CH1	MINS	10/23/2017	00:00:00	00:00:45	8MB	<input type="checkbox"/>	
2	CH1	MINS	10/23/2017	00:00:45	00:01:30	150MB	<input type="checkbox"/>	
3	CH1	MINS	10/23/2017	00:18:30	00:44:59	217MB	<input type="checkbox"/>	
4	CH1	MINS	10/23/2017	00:44:59	01:10:48	227MB	<input type="checkbox"/>	
5	CH1	MINS	10/23/2017	01:10:48	01:19:22	72MB	<input type="checkbox"/>	
6	CH1	MINS	10/23/2017	01:19:22	01:35:37	138MB	<input type="checkbox"/>	
7	CH1	MINS	10/23/2017	01:35:37	01:43:32	67MB	<input type="checkbox"/>	
8	CH1	MINS	10/23/2017	01:43:32	02:01:12	155MB	<input type="checkbox"/>	
9	CH1	MINS	10/23/2017	02:01:12	02:25:38	207MB	<input type="checkbox"/>	
10	CH1	MINS	10/23/2017	02:25:38	02:43:17	150MB	<input type="checkbox"/>	
11	CH1	MINS	10/23/2017	02:43:17	03:02:08	168MB	<input type="checkbox"/>	
12	CH1	MINS	10/23/2017	03:02:08	03:08:37	55MB	<input type="checkbox"/>	

In the detailed view mode, you can lock the video events to keep events from being overwritten in the hard drive. Click the icon to lock or click to unlock the events.

- When you click the left button of your mouse upon one of the event, system will show the event information on the left bottom corner of the screen.
- Check the box next the number of the event to select files, or check the box next **Select** to select all events in the page.
- The number of selected files, total size information will be displayed at the right bottom of the screen.
- After selecting file, you can click icon to save the video to USB flash drive. Or click icon into event playback control window to play the video.

6.1.2.1 Event Playback Control

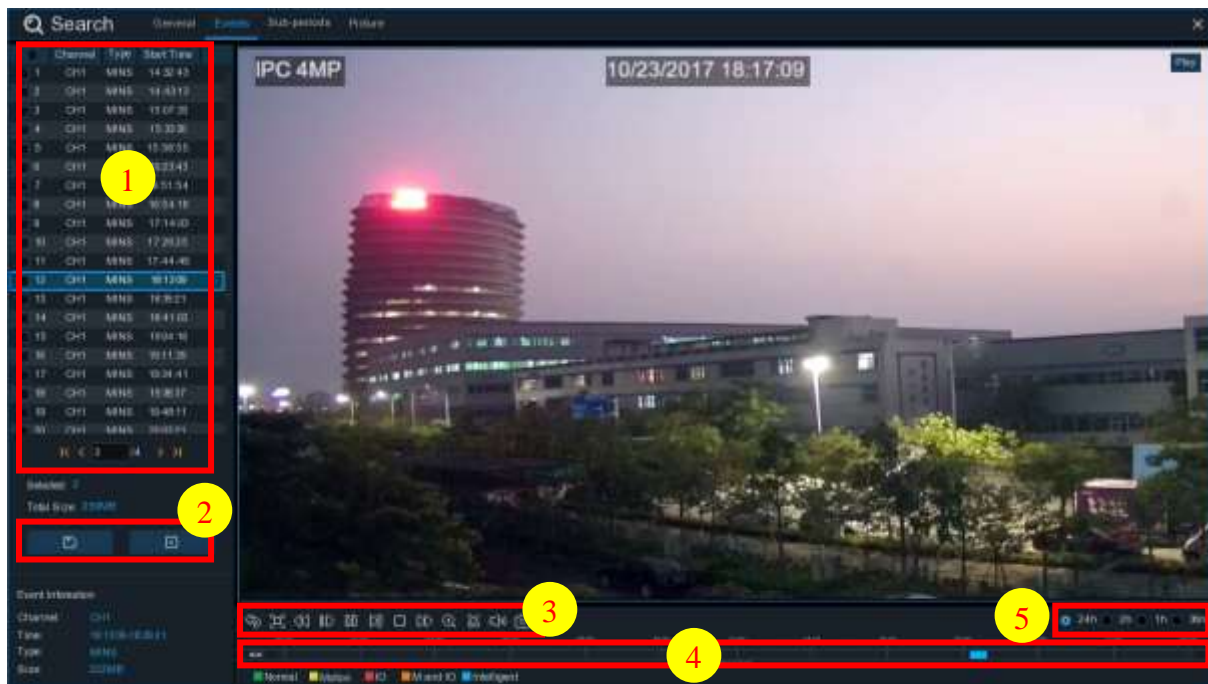

1. Event List, you can select the events here.
2. Click icon to save your selected event videos to USB flash drive. Click icon to play video.
3. Control the playback with buttons on **Video Playback Controls**. You can click icon or click right button of your mouse to exit the playback and return to event search window.
4. The event you are playing now will be displayed on the timeline.
5. Use the timeframe options (24h 2h 1h 30m) to view a smaller or larger time period.

6.1.3 Sub-periods Playback

Sub-periods playback allows you to play multiple normal recordings and motion events simultaneously from a single channel. With normal and event recordings, the video is divided evenly depending on the split-screen mode that has been selected. For example, if the video is an hour long and you have selected Split-screens x 4, each split-screen will play for 15 minutes.



To search & play video in sub-periods:

1. Choose the date & time you want to search.
2. Choose the split-screens you want the videos to be played in.
3. Check the recording types you want to search, or check **Search Type** to choose all.
4. Choose the channels you want to search. Note that this function only supports to search & play one channel at a time.
5. Click the play button to start playing. Control the playback with buttons on **Video Playback Controls**.
6. Videos are being played in split-screens.
7. Click the left button of your mouse upon a particular split-screen, the time period of the video split-screen will be displayed on the timeline. The color bar on the top of the timeline indicates the time span of the video split-screen you have clicked. The color bar on the bottom of the timeline indicates the time span for the whole videos you have searched.



8. Use the timeframe options (24h 2h 1h 30m) to view a smaller or larger time period.

6.1.4 Smart Search



With Smart search function, you will be able to quickly search and play the motion recording videos which were triggered by human beings.



To search & play video in Smart Search:

1. Choose the date & time you want to search.
2. Check the recording types you want to search, or check **Search Type** to choose all.
3. Choose the channel you want to search. Smart Search supports to search & play one channel only at a time.
4. The Smart Search result will be displayed in the time slot in blue color.



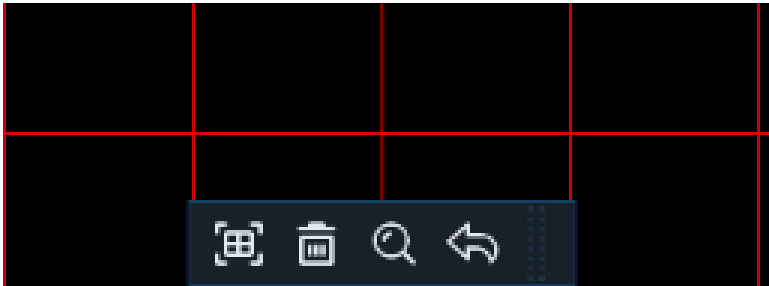

5. Click the play button  to start playing. Control the playback with buttons on **Playback Controls**.
6. It supports to narrow the search by selecting a certain area in the images. Click the  icon on the **Playback Controls** bar, the area selection page will be displayed.





The selected area will be marked with red grids.

: select whole image.

: clear your selection.

: go back to playback interface.

: search.

Click  button to clear all selection, and then use your mouse to select the certain areas you want to search in the image. Click  button, the system will search the display the smart search result for the selected areas.

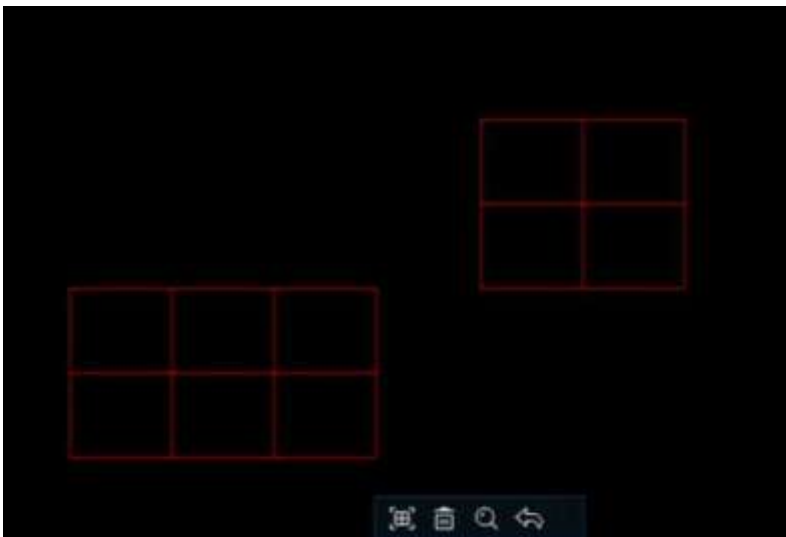

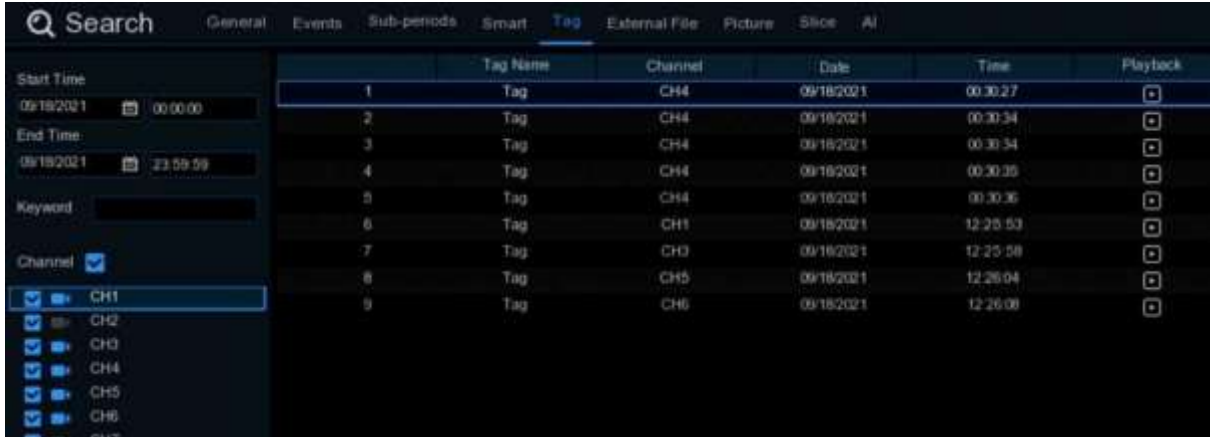

6.1.5 Tag Search

You can search, play and manage the contents with tags you added in live view and/or playback.



	Tag Name	Channel	Date	Time	Playback
1	Tag	CH4	09/18/2021	00:30:27	
2	Tag	CH4	09/18/2021	00:30:34	
3	Tag	CH4	09/18/2021	00:30:34	
4	Tag	CH4	09/18/2021	00:30:35	
5	Tag	CH4	09/18/2021	00:30:36	
6	Tag	CH1	09/18/2021	12:25:53	
7	Tag	CH0	09/18/2021	12:25:58	
8	Tag	CH5	09/18/2021	12:26:04	
9	Tag	CH6	09/18/2021	12:26:08	

1. Select the start time and end time you want to search.
2. Select the channel(s) you want to search.
3. If you gave customized tag names to the tags, you can input the keyword to narrow your search.
4. Click  button to search. The tags will be displayed on the right window. Click the play button to start playing.
5. If you want to modify the tag name, click  button. Click  button to delete the tag.

6.1.6 Play External File

The NVR supports to play the videos saved in the external USB memories.



Insert your USB memory into the USB port, find out the folder where the video files are saved, and then click the play icon  to play the video.

6.1.7 Picture Search & View

This function can be used to search, play and copy snapshots to a USB flash drive.



To search, play & back up pictures:

1. Choose the date & time you want to search.
2. Check the picture capture types you want to search, or check **Search Type** to choose all.
3. Choose the channels you want to search, or check **Channel** to choose all channels.
4. Click button to start search.
5. Pictures fitting your search criteria are displayed in list form. You can double click one of the pictures to get a larger view.
6. Click icons in the bottom-right corner of the menu to browse between pages of pictures, or input the page you want to browse.
7. You can switch the view of list form in by clicking below icons which is show at the right bottom corner of the screen:

Thumbnails view. You can view the snapshots of the events.

List view. The events will be displayed in list.

Detailed view. You can view the details of the events.

	Channel	Type	Date	Time	Size	Playback
<input type="checkbox"/> 1	CH1	MIN	10/24/2017	00:00:00	160KB	
<input type="checkbox"/> 2	CH1	MIN	10/24/2017	00:12:01	201KB	
<input type="checkbox"/> 3	CH1	MIN	10/24/2017	00:21:20	401KB	
<input type="checkbox"/> 4	CH1	MIN	10/24/2017	00:24:38	111KB	
<input type="checkbox"/> 5	CH1	MIN	10/24/2017	00:37:25	167KB	
<input type="checkbox"/> 6	CH1	MIN	10/24/2017	00:55:58	210KB	

8. When you click the left button of your mouse upon one of the pictures, system will show the picture information on the left bottom corner of the screen.
9. Check the box next the number of the event to select files, or check the box next **Select** to select all pictures in the page.
10. The number of selected files, total size information will be displayed at the right bottom of the screen.
11. After selecting file, you can click button to save the pictures to USB flash drive. Or click button to go into picture preview control window.

6.1.7.1 Picture Preview Control

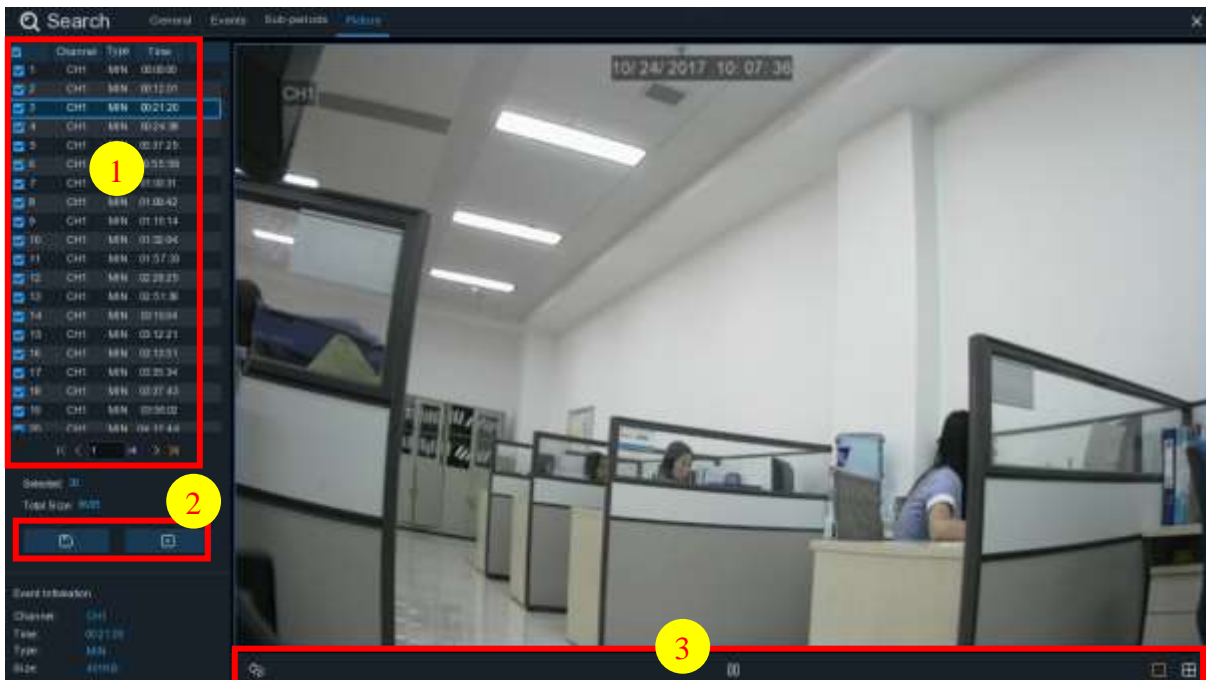

1. Picture List, you can select the pictures here.
2. Click button to save your selected pictures to a USB flash drive. Click button to view the pictures in slideshow.
3. Press button to exit preview control window and go back to picture search window.
 Press button to pause, press to resume slideshow.
 Press button to display previous snapshot or group of snapshots, press to display the next snapshot or group of snapshots.
 Click button to view a single snapshot at a time, click button to view four snapshots at a time, press buttons to view nine snapshots at a time.

6.1.8 Slice Search

This is a function to slice each hour's video into 60 fragments.

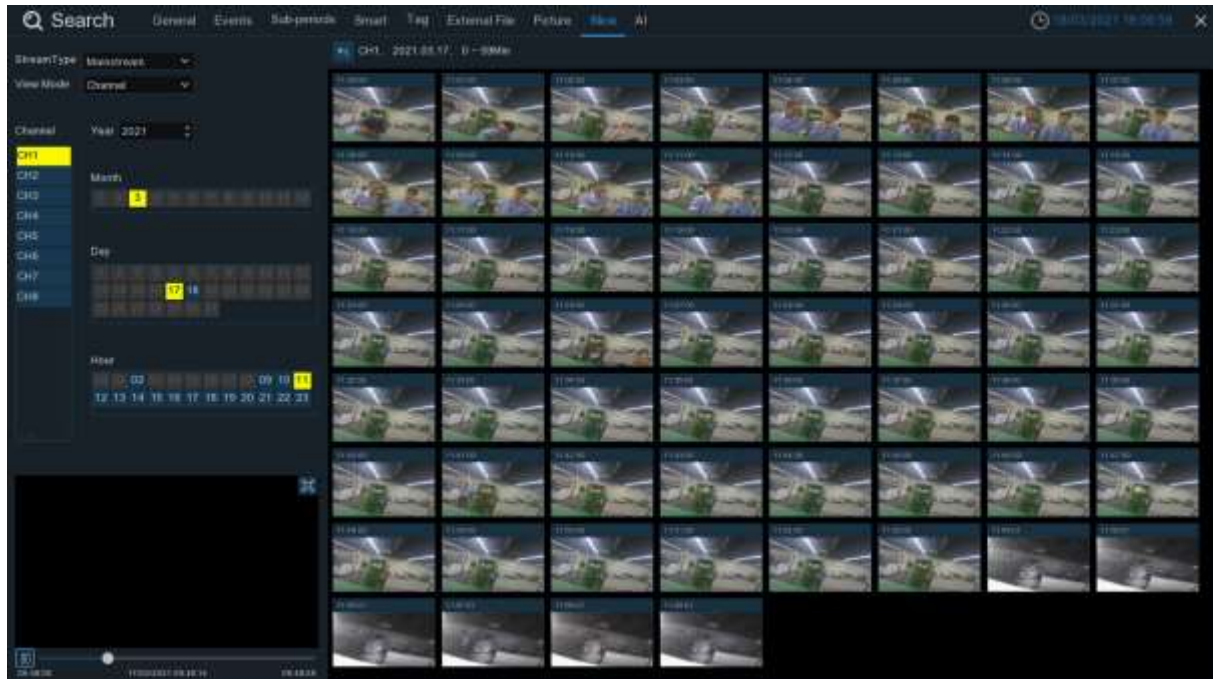

Choose the video stream type, channel, date, and hour. The system will display 60 thumbnail images of each minute on the screen. Click on any one of the thumbnail images, the video will be played on the left bottom corner.



6.1.9 AI Search

6.1.9.1 Face Search

Choose date, time, channel, groups to search all captured faces.

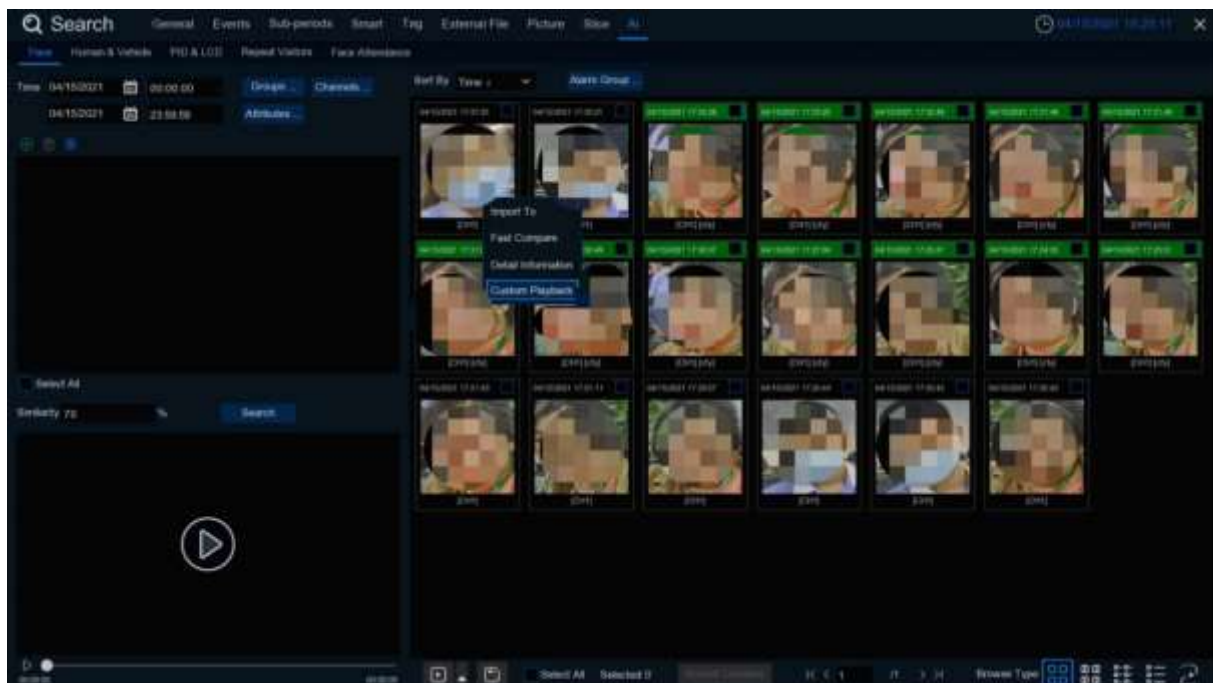
Note: The Face Search and Tracking functions are based on Face Detection and/or Face Recognition results. See [5.4.1.1 Face Detection](#) and [5.4.2 Face Recognition](#). Make sure **Face Attribute** is enabled in **Face Detection** before you can use facial features to find search results.



1. Click  icon to add customized faces.
2. Choose the **Channels** you want to search.
3. You can also set search conditions of the facial features in **Attributes**.
4. Choose the Face Recognition group in **Alarm Groups**.
5. Click  icon to configure the AI settings.
6. Click **Search**.

6.1.9.1.1 Face Tracking on E-Map

E-Map function helps track a person's faces.

Click the  icon to set the E-Map function.

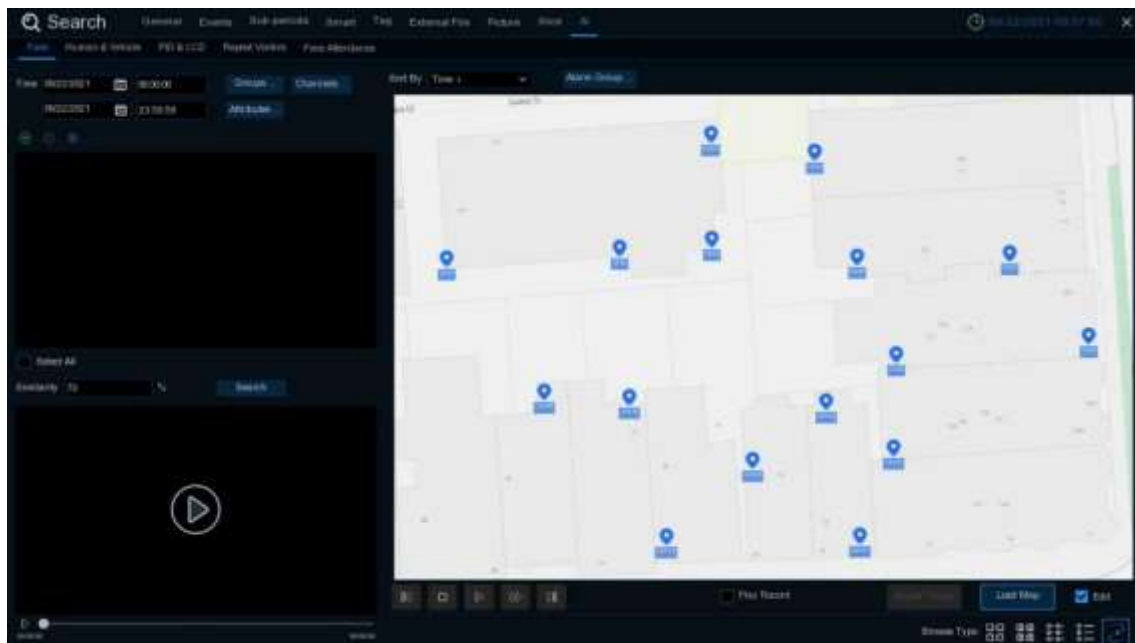

1. Click **Load Map** button to load a map image from your USB memory.
2. Check the **Edit** box. Click and hold the channel icon and move one by one to adjust the site of your IP cameras on the map. Uncheck the **Edit** box to quit the edition.



- Click  icon to select one face image from local storage or external USB storage. Select date & time, group(s), channel(s), set the similarity rate, and then click **Search** button. The system will display the result on the e-map. If the person was captured by multiple cameras, the system will display his/her moving track on the map.

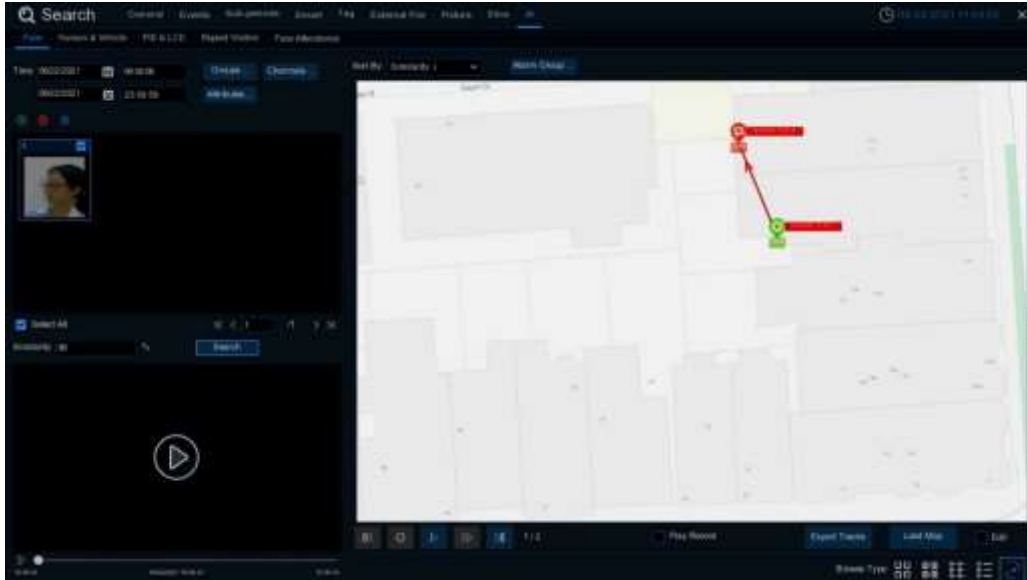

- Click one of the sites on the map, it will display the captured date & time. Click the **Play** button, the recorded video will be played in the left bottom corner.

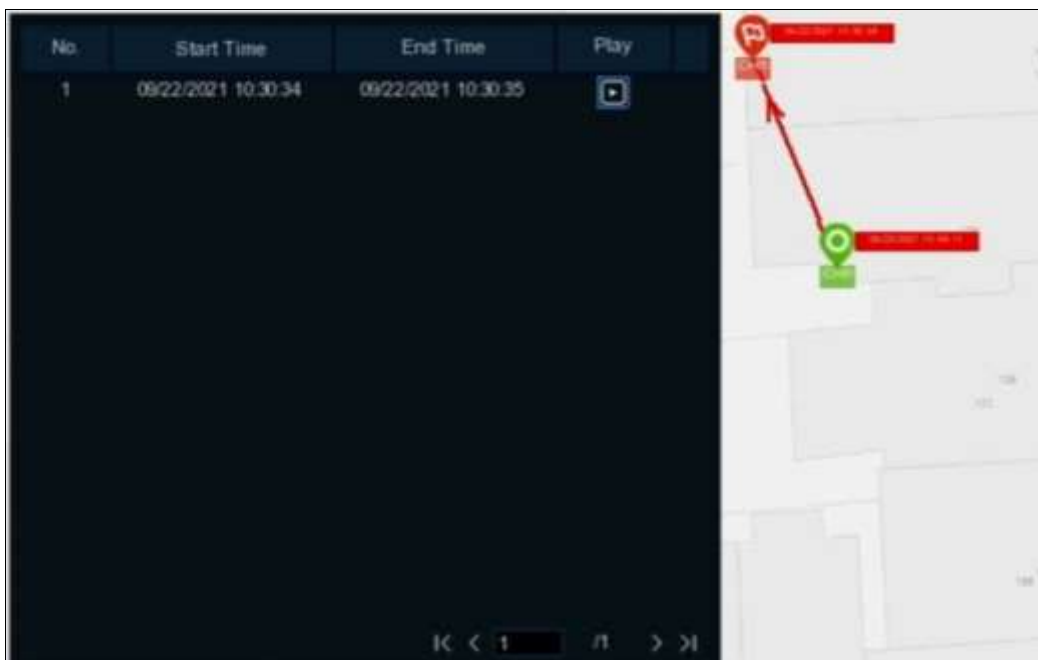

-
5. Click the play button  on the play control, the system will automatically demonstrate the moving track. Check the **Play Record** box, recorded videos will be played meanwhile.

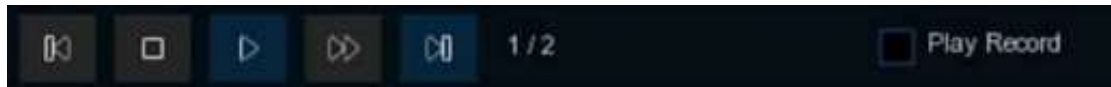

Note: The tracking function is only applicable to one person at a time.

6.1.9.2 Human & Vehicle

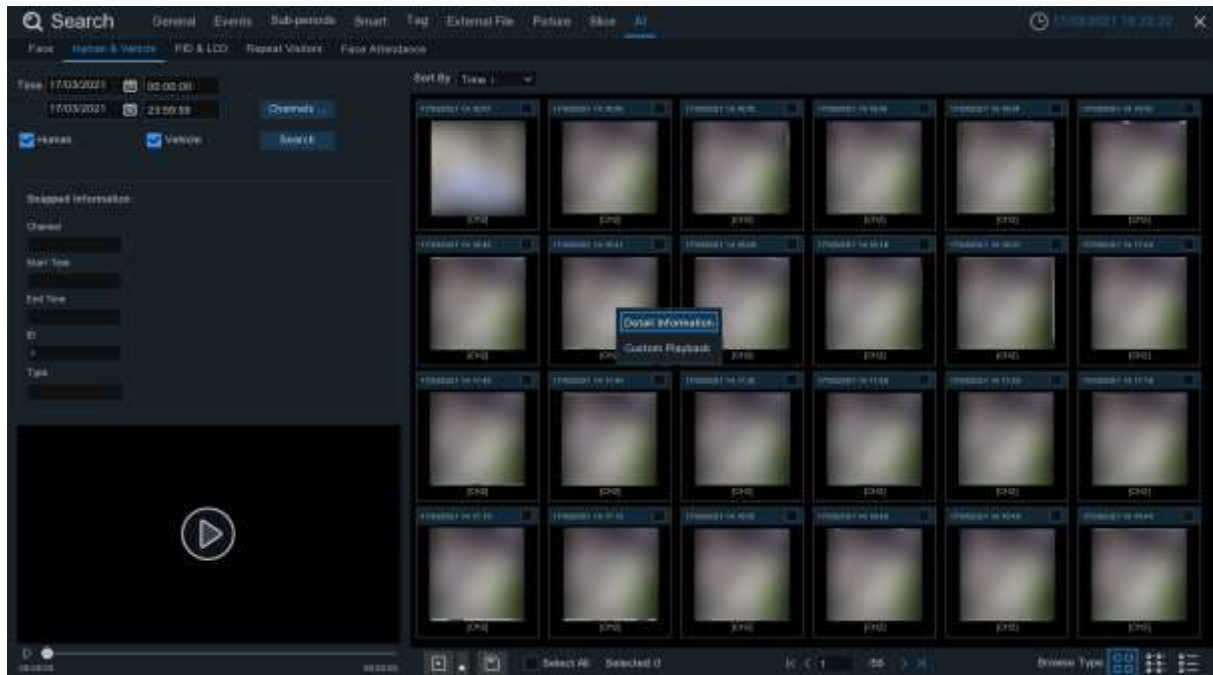

The system provides a quick search for pedestrians and vehicles.



1. Select the date & time, channel(s).
2. Choose the detection type: **Human** and/or **Vehicle**.
3. Click **Search**, the result will be displayed on the right side of the window.
4. Click one of the images, the system will show its basic information on the left side of the window, and the video will be played on the left bottom side.

5. Right click your mouse upon one of the images, you will have 2 options:
 - A. To view the file information.
 - B. To start playback of the file.



6. Choose one or more files, click the play button , the system will turn to the playback interface to play the selected file(s). Click the  icon to select the time duration you would like to play. Click  to save the selected file(s) to your USB memory.



6.1.9.3 PID & LCD

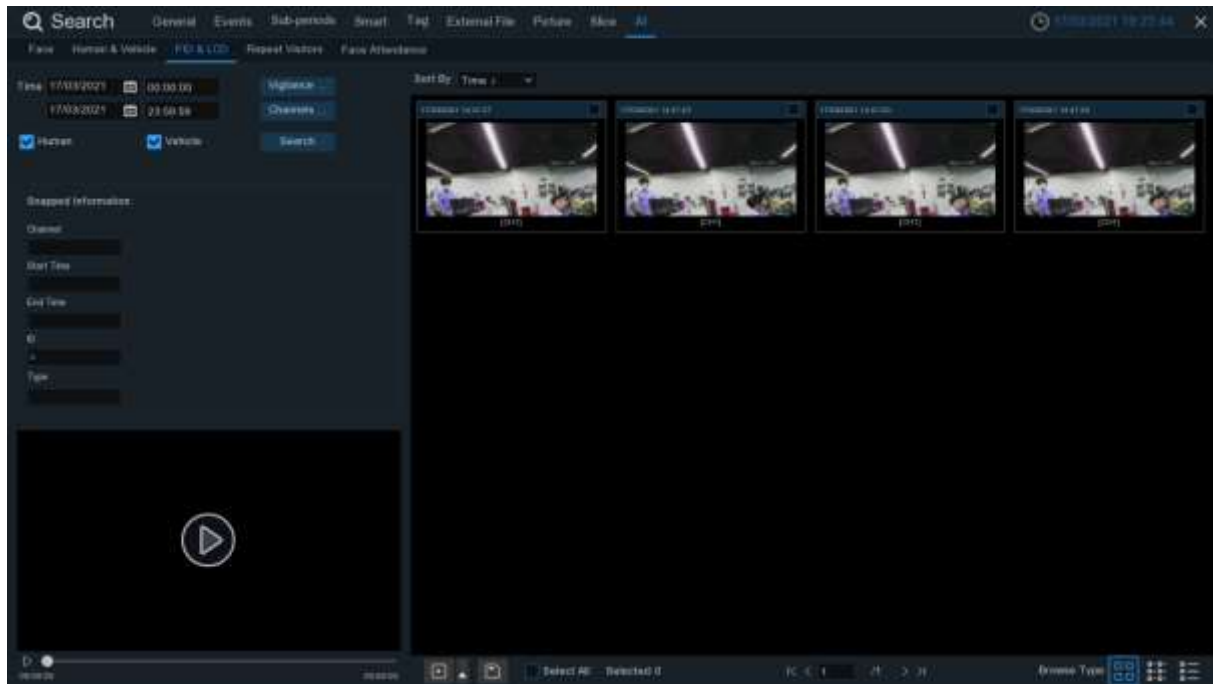

The system provides a quick search for PID & LCD.



1. Select the date & time, channel(s).
2. Select PID and/or LCD in **Vigilance**.
3. Choose the detection type: **Human** and/or **Vehicle**.
4. Click **Search**, the result will be displayed on the right side of the window.
5. Click one of the images, the system will show its basic information on the left side of the window, and the video will be played on the left bottom side.

6. Right click your mouse upon one of the images, you will have 2 options:
 - A. To view the file information.
 - B. To start playback of the file.



7. Choose one or more files, click the play button , the system will turn to the playback interface to play the selected file(s). Click the  icon to select the time duration you would like to play. Click  to save the selected file(s) to your USB memory.

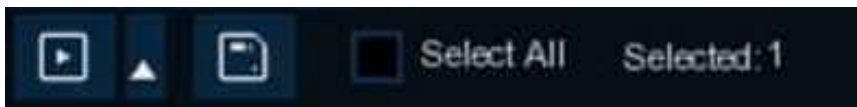

6.1.9.4 Repeat Visitors

This is a function to conduct a quick search of the occurrence frequency of persons in a certain time period.

Note: The Repeat Visitors function is based Face Detection and/or Face Recognition results. See 5.4.1.1 Face Detection and 5.4.2 Face Recognition. Make sure **Face Attribute** is enabled in **Face Detection** before you can use facial features to find search results.

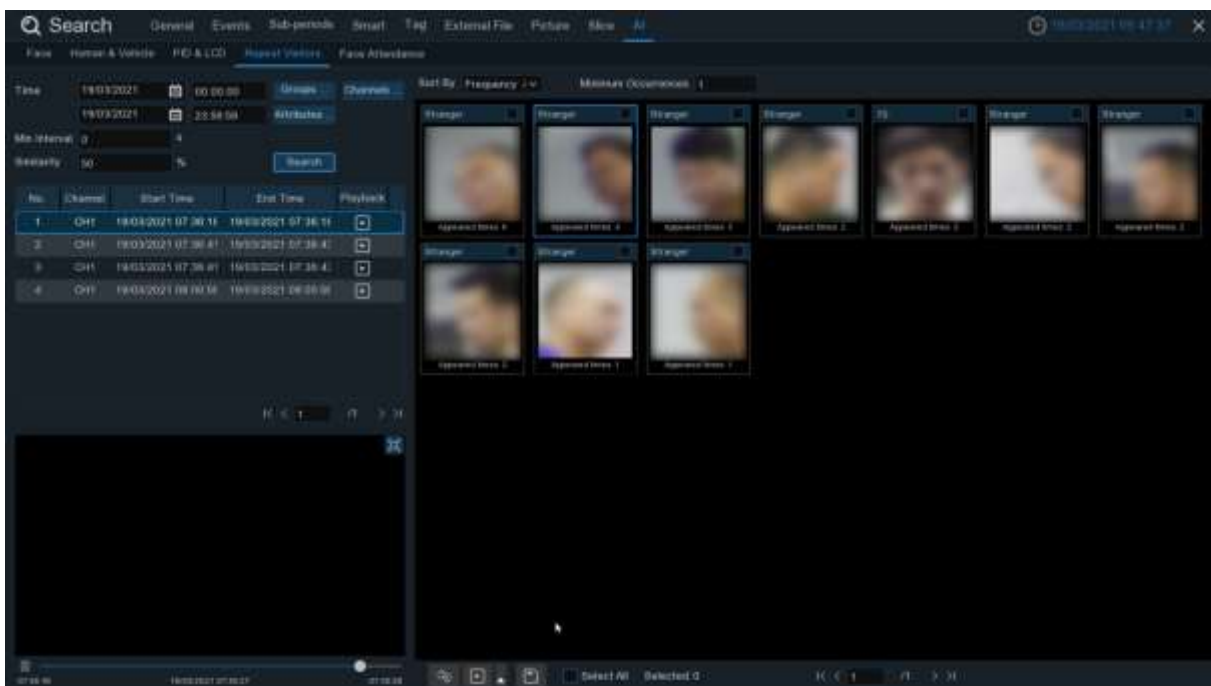

1. Select the date & time, group(s) & channel(s).
2. Set the **Attributes**.
3. Set the **Min. Interval** time (in seconds) and **Similarity**.
4. Click **Search**, the result will be displayed on the right side of the window.
5. You can sort the result by **Time** and **Frequency**.
6. You can narrow the result by setting the **Minimum Occurrence** number.
7. Click one of the images, the system will show its relative information, including channel, captured start and end time on the left side of the window, and the video will be played on the left bottom side.

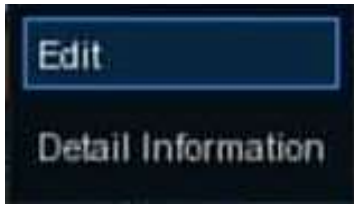

8. Right click your mouse on one of the images, you will have 2 options:



A. If the face exists in the face database, you are able to edit and check the face information.



B. If the face doesn't exist in the face database, you are able to add and check the face information.

9. Choose one or more files, click the play button . The system will turn to the playback interface to play the selected file(s). Click the  icon to select the time duration you would like to play. Click  to save the selected file(s) to your USB memory.

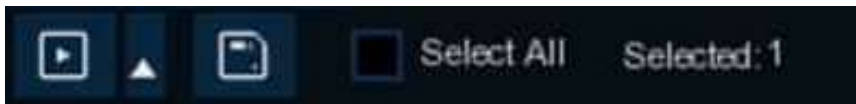



6.1.9.5 Face Attendance

Face Attendance is used to assist in attendance checking by faces. It will help analyze the absenteeism, coming late and leaving early.

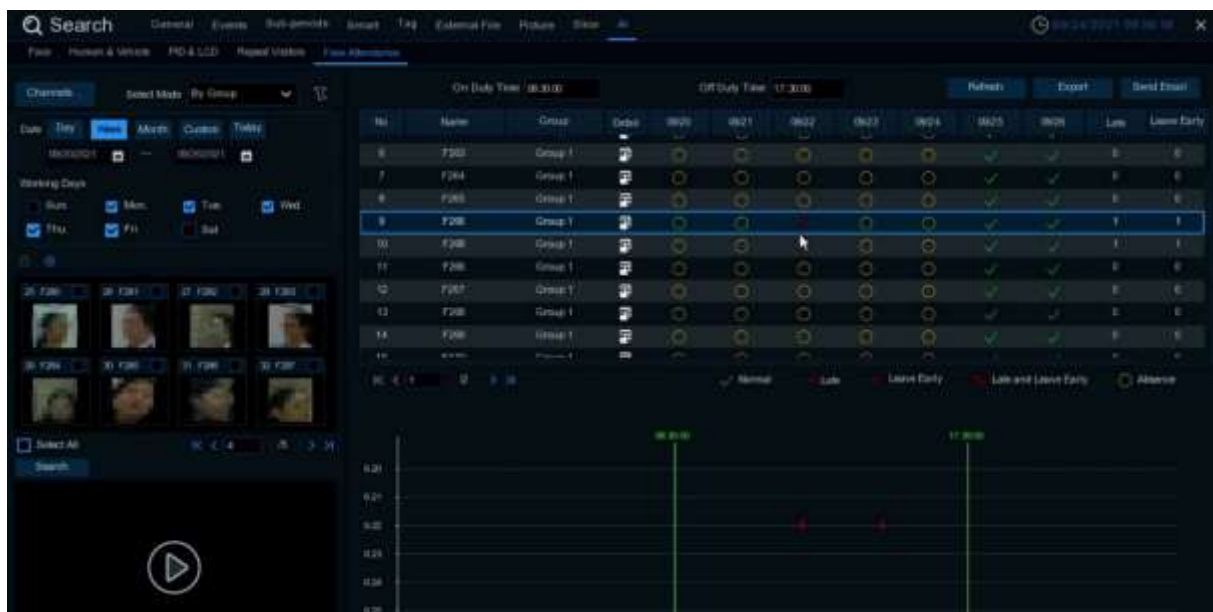
Note: The Face Attendance function is based Face Detection and/or Face Recognition results. See 5.4.1.1 Face Detection and 5.4.2 Face Recognition.



1. Select the channel(s).
2. **Select Mode** by Group or by Person. If you choose **By Group**, all the persons in the selected group(s) will be searched. If you choose **By Person**, only your selected person(s) will be searched. Click the filter icon  to choose group(s) or person(s). Your selected person(s) will be displayed on the left middle side of the window.
3. Select the search date by individual day, week, month, current day, or customized date.
4. Set the **Working Days**, **On Duty Time** and **Off Duty Time**.
5. Click **Search** button, the result will be displayed on the right side of the window.
6. You can export or email the data.
7. Click on the detail icon , you will see the captured images and videos of the first occurrence and the last occurrence of the person in the day. Click on the play button  to access a quick playback.

Chapter 7 Remote Access via Web Client

Use the Web Client to remotely access your NVR at any time via a PC. Before you access the Web Client, you need to ensure that the internet settings of the NVR are configured properly.

7.1 Basic System Environment Requirements

The minimum requirements for hardware and OS required to run Web Client are given as below.

Item	Minimum	Recommended
CPU	Intel® Core™ i5 CPU	Intel® Core™ i5 CPU or higher
RAM	4G or more	8G or more
Hard Drive	500G or more	1000G or more
Display RAM	2G or more	4G or more
Display Resolution	1280*1024	1920*1080
OS	Windows 7 or above Mac OS X® 10.9 or above	
DirectX	DirectX 11	
Direct3D	Acceleration Function	
Ethernet Adapter	10/100/1000M Ethernet Adapter	
Browser	IE 10 / 11 Safari V12.1 or above Firefox V52 or above Google Chrome V57 or above Edge V79 or above	

7.2 Web Plugin Download and Installation

To access the Web Client, do the following:

For IE/Chrome/Firefox:

1. Launch the explorer on your PC and enter the NVR IP address or DDNS domain name (Host Name) you have set on NVR in the URL box.
2. For the first time you run the web client, system will require to install the web client plugin. Click **download** to download the plugin and install to your computer.

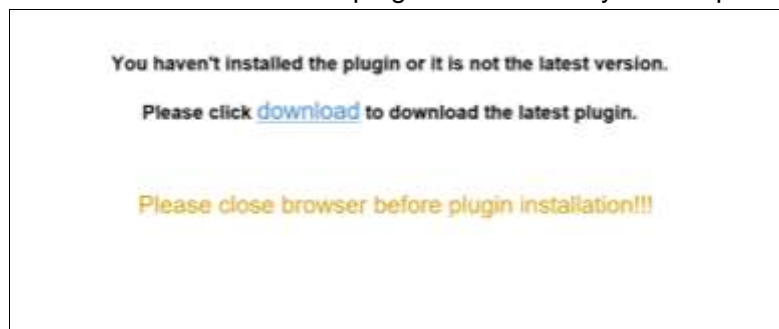

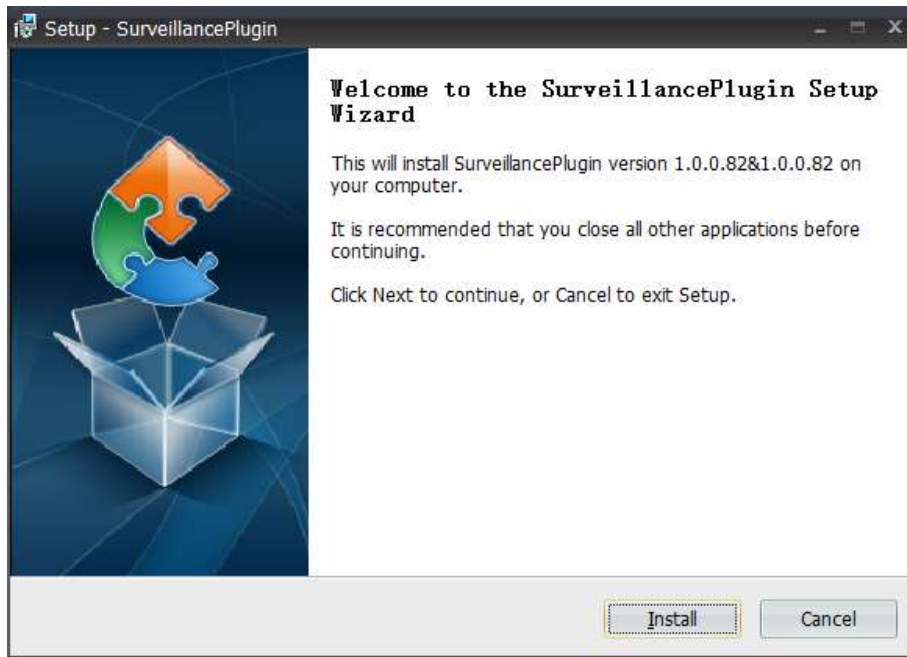

3. After installing the plug-in, close & launch again your browser and repeat step 1 to open the login page. Input your user name and password to login the web client.

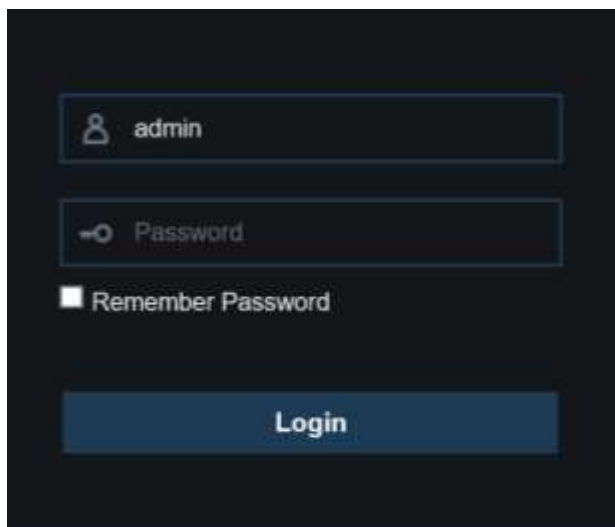

For Mac Safari:

1. Launch the Safari in your Mac, and enter the NVR IP address or DDNS domain name (Host Name) you have set on NVR in the URL box.



2. Download the plug-in "SurveillanceClient.dmg", locate the downloaded file and double click it.



3. Click on "Continue" --> "Install". Enter user name and password for Mac computer, Click on "Install Software" --> "Close" to finish installation.

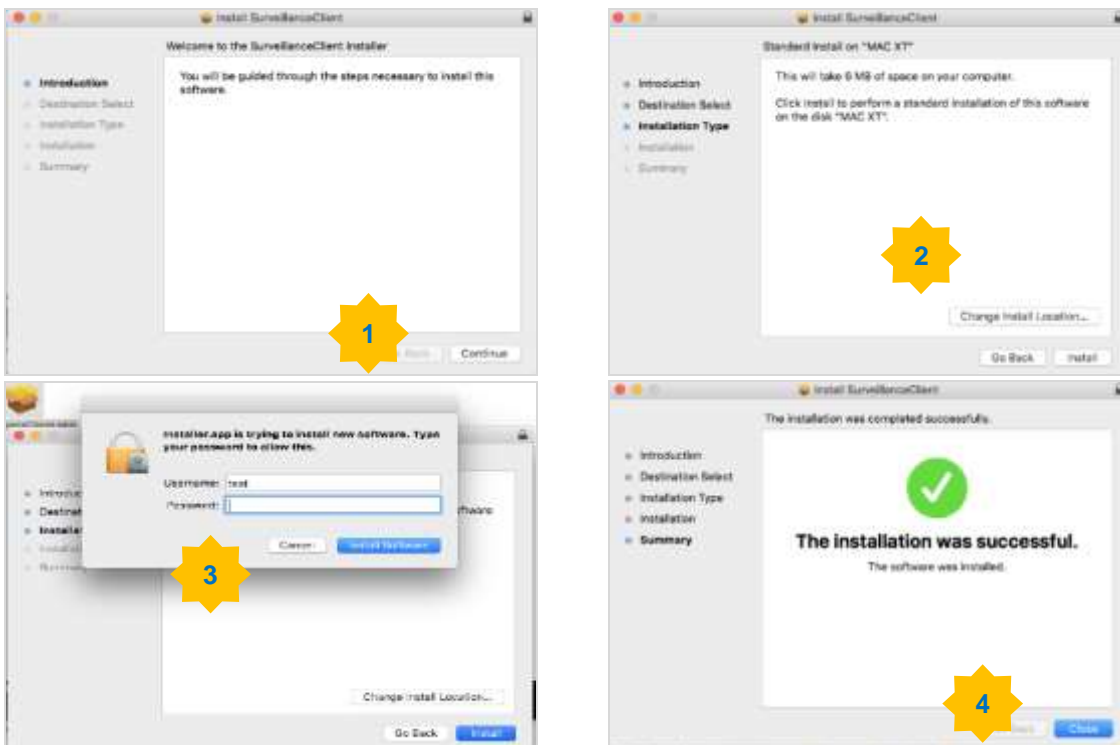

4. Close Safari and open again to repeat step 1 to open the Web Client login page.

7.3 Web Client Manager

The web client supports to fully control the NVR with administrator account. Make sure to protect your user name & password for preventing illegal login.

7.3.1 Live Interface

This is the first screen that opens after you have logged in to the Web Client. Here you can open or close live preview, record video to local computer manually, take snapshots of the screens, PTZ control, color adjustment, etc.

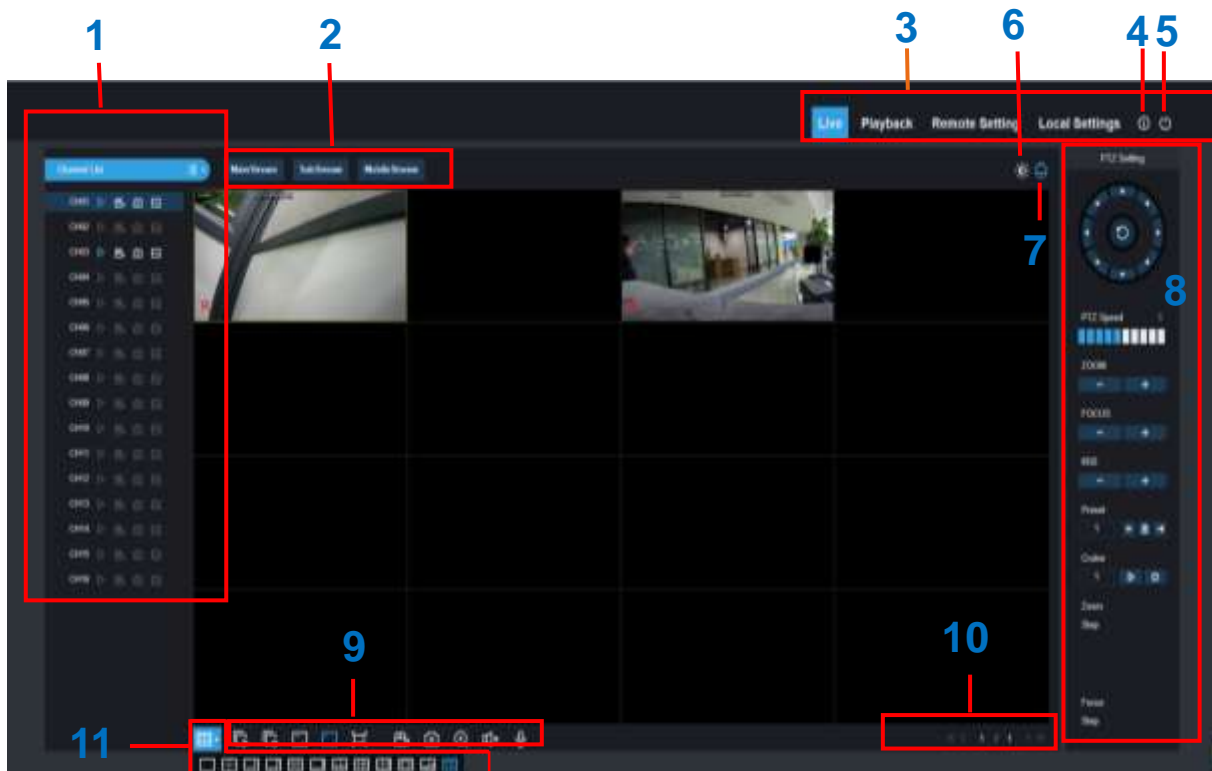

1- Channel List: Open the channel list for quick camera function

Click button to display the Channel List.

Click button to hide the Channel List.

- Turn the Live video stream on/off. The button is in blue color if the live video stream is on.
- Manual Recording buttons. Click to start manually recording live stream video. Click again to stop recording. Manual recordings are saved to your computer. While in recording, the button is in blue color.
- Manual snapshot button. Click to save a snapshot of the current live display to your computer.
- Bitrate button. Set camera to use mainstream, substream or mobile stream video settings. Mobile stream is available for IP channels only.

2- Live Video Stream Options:

Mainstream: View all live videos using high-quality mainstream video settings.

Substream: View all live videos using middle-quality substream video settings.

Mobile Stream: View all live video using lower-quality mobile stream video settings to conserve bandwidth. Available for IP channels only.

3- Main Menu:

Live: View live video from cameras.

Playback: View recorded video which is saved in NVR's HDD.

Remote Setting: Access functions of the NVR setting menus.

Local Settings: Set download locations for recordings and snapshots taken using Web Client, and choose file type for video files.

4- Information: Hover over to see system details.

5- Exit.

6- Color Controls. Click to display or hide the color controls.

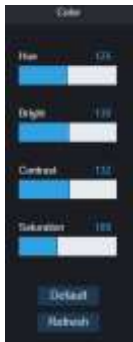

7- PTZ Controls: Click to display or hide the PTZ controls for using PTZ cameras.

8- PTZ Controls



9- Live View Control Buttons:



- Open the images on Live window.
- Close all the Live channels
- Original Proportions: Shows live video at the original proportions
- Stretch: Stretch live video to fit the full area for each channel on screen.
- To enlarge the web client to full screen.
- Manual Recording: Click to start manually recording for all displayed channels. Click again to stop recording. Manual recordings are saved to your computer.
- Snapshot: Click to save snapshots of all current displayed channels to your computer.
- Digital Zoom: Click upon on a live image, then click-and-drag over an area of the live image to enlarge. Right-click to return to the normal display.
- Volume Control. Volume is mute.

10- Navigation: Shows current page number for the channels shown on screen. Use the arrow keys to switch between pages.

11- Page View: Click to select how many channels appear on screen at a time.

7.3.2 Playback

You can search & play recording videos stored in the HDD inside the NVR, and download the videos to your computer.

Note: To play the video clips downloaded from the Web Client Manager, install and launch one of the following players **before** locating the recordings. Wait for 3 ~ 30 seconds before the video starts to play.

1. [USA Vision Player](#)
2. [VLC Media Player](#)
3. [KM Player](#)

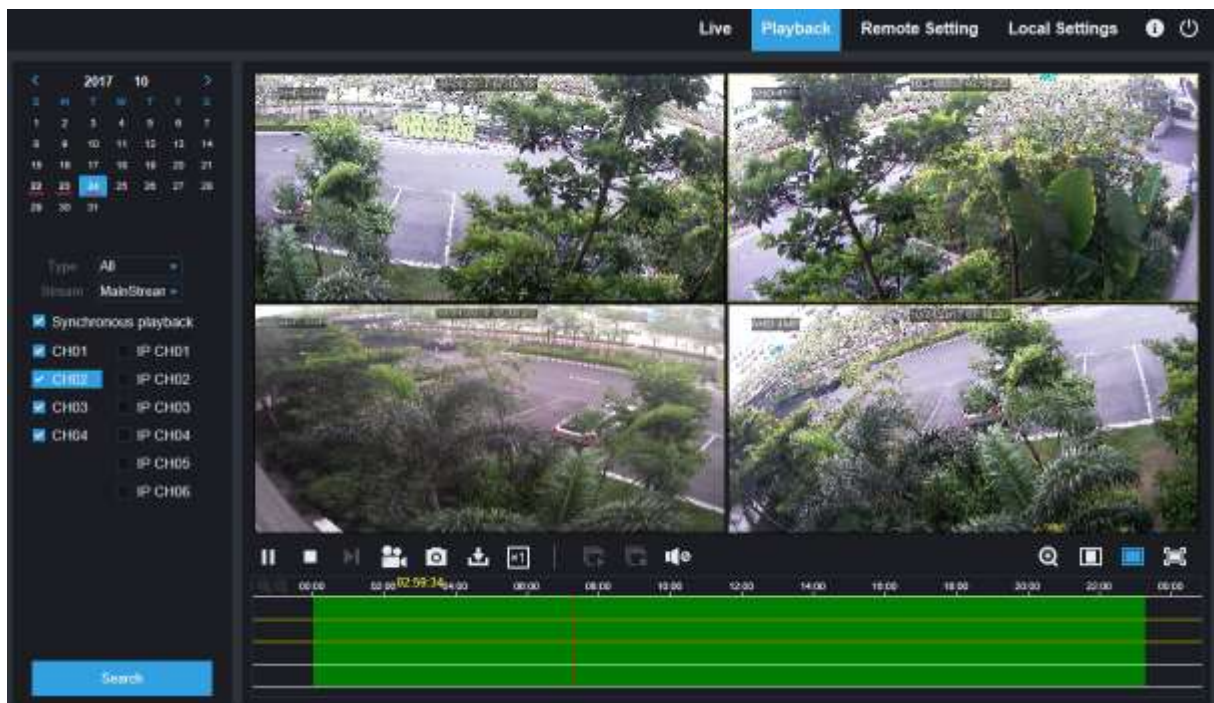

To search recordings:

1. Click **Playback** in the top-right corner of the window.
2. Select a day on the calendar to search for recordings from. Days with recordings appear with a red underline.
3. Select the recording type to search for from the dropdown next to Type, or select All to search for all recordings.
4. To choose the video stream you want to search & play. If you want to play Substream recordings, make sure you had set the NVR to record with Dualstream at [5.2.2.1 Record](#).
5. Check the channels you would like to search for recordings from. Check **Synchronous playback** to play all channels at once.

6. Click [Search](#).
7. Recordings that fit your search will be displayed in the timeline. Click a section of video where you would like to begin playback and click the ▶ play button.

7.3.2.1 Playback Control Buttons

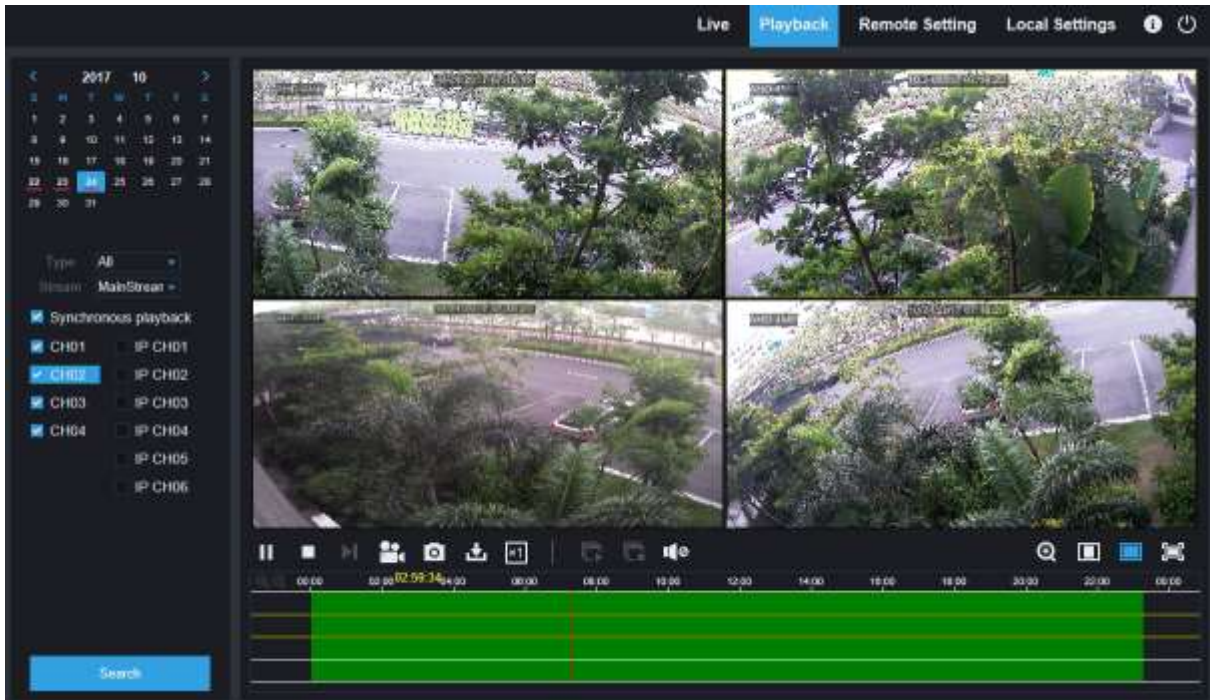

▶ **Play the recordings**

|| **Pause**

■ **Stop**

▶ **Go Forward One Frame:** Move frame-by-frame through playback. Only available when the [Synchronous playback](#) option is not checked.

📹 Click upon one of the channels which is being played and then click record button to record current video to your computer. Click again to stop recording.

📷 Click upon one of the channels which is being played and then click capture button to take a snapshot and save to your computer.

⬇️ Opens the Download menu, which allows you to download several video recordings at once.

	<input type="checkbox"/>	Start Time	End Time	Status	File Size
1	<input checked="" type="checkbox"/>	2017-10-25 00:00:00	2017-10-25 00:01:04	Completed	47.00M
2	<input checked="" type="checkbox"/>	2017-10-25 00:01:04	2017-10-25 00:06:56	2%	253.76M
3	<input type="checkbox"/>	2017-10-25 00:06:56	2017-10-25 00:12:48	Not Downloaded	253.71M
4	<input type="checkbox"/>	2017-10-25 00:12:48	2017-10-25 00:18:41	Not Downloaded	253.91M
5	<input type="checkbox"/>	2017-10-25 00:18:41	2017-10-25 00:24:34	Not Downloaded	253.64M
6	<input type="checkbox"/>	2017-10-25 00:24:34	2017-10-25 00:30:27	Not Downloaded	253.68M
7	<input type="checkbox"/>	2017-10-25 00:30:27	2017-10-25 00:36:18	Not Downloaded	253.75M
8	<input type="checkbox"/>	2017-10-25 00:36:18	2017-10-25 00:42:10	Not Downloaded	253.90M
9	<input type="checkbox"/>	2017-10-25 00:42:10	2017-10-25 00:48:03	Not Downloaded	253.74M
10	<input type="checkbox"/>	2017-10-25 00:48:03	2017-10-25 00:53:56	Not Downloaded	253.63M

|
 |
 / 10 |

Show from 1 to 10, total 95. Per page : 10

Start Download
Stop Download

Choose the files you want to download, press **Start Download** button to begin, you will see the download status. Press **Stop Download** button to stop.

 **Playback Speed.** Click to choose the playing speed.

 **Play All Channels:** Click to play all channels you have chosen to searched. Only available when the **Synchronous playback** option is not checked.

 **Stop All Channels:** Click to stop playing all channels. Only available when the **Synchronous playback** option is not checked.

 **Digital Zoom:** Click upon on a playing video, then click-and-drag over an area of the video to enlarge. Right-click to return to the normal display.

 **Original Proportions:** Shows the playing video at the original proportions

 **Stretch:** Stretch the playing video to fit the full area for each channel on screen.

 **To enlarge the web client to full screen.**

7.3.3 Remote Setting

Here you can remotely configure the settings of the NVR. See [“Chapter 5 NVR System Setup”](#) for details on the NVR settings.

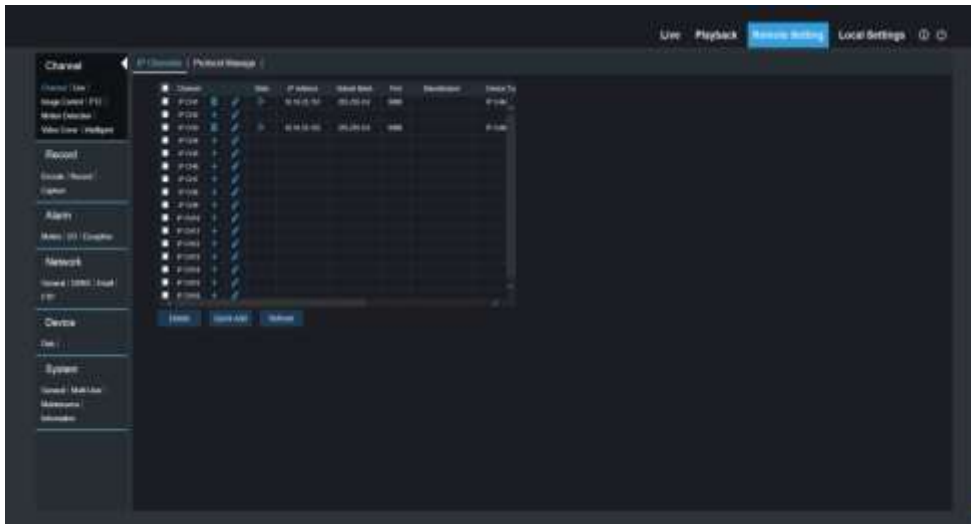

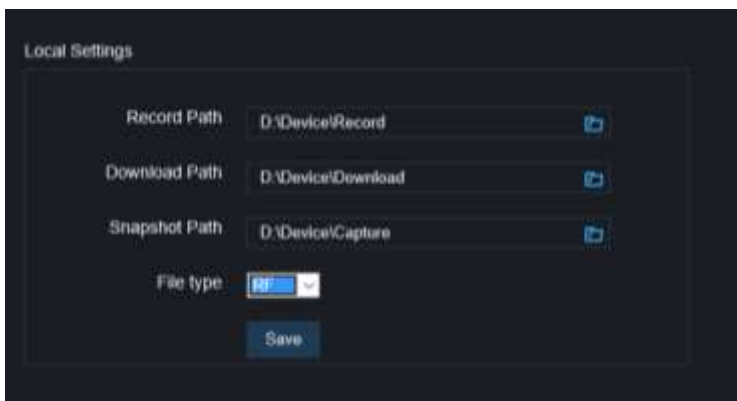

7.3.4 Local Setting

Set download locations for recordings and snapshots taken using Web Client, and choose file type for video files.



Record Path: Click  to browse for and select the folder where you would like the manual video recordings to be saved on your computer.

Download Path: Click  to browse for and select the folder where you would like to save the download video recordings to your computer.

Snapshot Path: Click  to browse for and select the folder where you would like the manual capture snapshots to be saved on your computer.

File Type: Choose your preferred file type for manual recordings.

Save: Click to save the modifications.

Appendix

A. Supported Hard Disk Drives

To see the supported hard disk drives for UA-SNVR models, see the UA-SNVR HDD Compatibility Table [here](#).

B. Troubleshooting

1. **Q: What can I do if the system does not detect the HDD?**

A: Check if the power supply system is properly connected and data cord and power cables are securely connected, and if something wrong with the HDD interface. Or you may check if your HDD is supported by referring to the specifications or descriptions.

2. **Q: I have changed the password but forget the new password, how can I access the system?**

A: If you forget system password, consult with our technical personnel. We strongly suggest user to set password easy to be remembered and relatively safe. If you have safety requirement, do not set very simply password, such as 000000.

3. **Q: We see abnormal video signal or even no video signal by connecting the NVR and camera together. Power supply for both devices is OK. What is wrong?**

A: Check network cable at NVR side to see if the cable is firmly connected and if it is worn out and needs to be replaced, or to check if NTSC or PAL is selected consistently.

4. **Q: How to prevent NVR from being influenced by heat?**

A: The NVR needs to dissipate heat while it is running. Place the NVR in a place with good air circulation and away from heat sources to ensure stability and life of the NVR.

5. **Q: The remote controller of NVR doesn't work while the monitor screen is OK and panel keys are functional. Why?**

A: Operate again by aiming the remote controller at the IR receiver on front panel. If it still doesn't work, check if the batteries in the remote controller are dying. If not, check if the remote controller is broken.

6. **Q: I want to take out HDD from my PC and install it in NVR. Can it work?**

A: All HDDs supported by the system can be used. But remember, once NVR runs, the data on your HDD will be lost.

7. **Q: Can I play back while recording?**

A: Yes. The system supports the function of playing while recording.

8. **Q: Can I clear some records on HDD of NVR?**

A: In consideration of the file security, you may not clear part of records. If you want to remove all the records, you can format HDD.

9. **Q: Why can't I log in NVR client?**

A: Check if the network connection settings are correct and RJ-45 port is with good contact. And check if your account and password are correctly input.

10. **Q: Why can't I find any records during playback?**

A: Check if the data line connection for HDD is OK and system time is properly adjusted. Try a few times and restart. If it still doesn't work, check if the HDD is broken.

11.

Q: Why NVR cannot control PTZ?

A: Check if:

- a) PTZ in the front side is malfunctioned.
 - b) Setting, connection and installation of PTZ decoder are not correct.
 - c) PTZ setting of NVR is not correct.
 - d) Protocol of PTZ decoder does not match that of NVR.
 - e) Address of PTZ decoder does not match that of NVR.
 - f) If many decoders are connected, the farthest side of AB line of PTZ decoder should be added 120Ω resistance to realize reflection suppression and impedance matching.
- Otherwise, PTZ control will be unstable.

12. **Q: Why doesn't dynamic detection work?**

A: Check if the motion detection time and motion detection regional setting are correct and if the sensitivity is set too low.

13. **Q: Why doesn't alarm work?**

A: Check if the alarm setting, alarm connection and alarm input signals are correct.

14. **Q: Why does buzzer keep alarming?**

A: Check the alarm setting, check if motion detection function is enabled and object motion is detected all the time and if I/O alarm is set as Always Off. Besides, refer to corresponding HDD alarm setting.

15. **Q: Why can't I stop recording by pressing "STOP" button or click "Stop Recording" in context menu?**

A: Pressing Stop or Stop Recording can only stop manual record. If you want to stop Scheduled recording in certain time quantum, change the setting to No Record. To stop Startup recording, change record mode to scheduled recording or manual recording. Then you may stop recording by the prescribed methods. And another way of stopping recording is to set channel as off status in record setting.

C. Usage Maintenance

1. To shut down NVR, firstly shut down the system and then turn off the power. Do not turn off the power directly or HDD data will be lost or damaged.
2. Keep NVR away from heat sources or places.
3. Clean the internal dust regularly. Make sure the good ventilation of NVR so as to ensure the good heat dissipation.
4. Do not hot plugging audio and video cables, or cables connected to ports like RS-232 or RS-485. Otherwise the ports will be damaged.
5. Check the HDD cable and data cable regularly to see if they are ageing.
6. Prevent the audio and video signals of NVR from being intervened by other electronic devices, and prevent the HDD from being damaged by static electricity and induced voltage. If the network cable is frequently plugged, it is suggested to replace connecting line regularly, or the input signal may be unstable.