

CAMERA KIT

What's Included



(1) SEAGATE SKYHAWK 1TB SURVEILLANCE HARD DRIVE



X8

(8) 100 FEET CAT5E CABLE



16 CHANNEL 12MP+ 2X SATA PORT NVR



X8

IMAX FOCUS 4MP FIXED TURRET NETWORK SECURITY CAMERA

4MP



16 CHANNEL 12MP, 2X SATA PORTS NVR & (8) 4MP IPC TURRET 2.8MM FIXED SECURITY CAMERA KIT



SKU: WEC8ACPCK8T4

SKU: WEC8ACPCK8T4



*THIS QR CODE WILL REDIRECT YOU TO THE PRODUCT PAGE OF THE ITEM LISTED ABOVE.



WHY CHOOSE IMAXFOCUS?

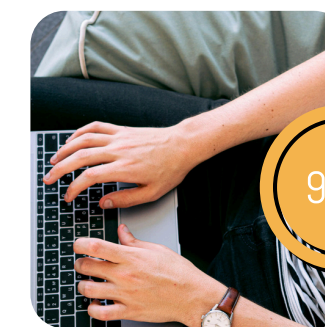

Quick Search

SAVE UP TO 99% OF SEARCH TIME



Easy Operation

1 PICK EXTRACTS VIDEOS



High Accuracy

BASED ON AI FUSION ALGORITHM



IMPROVED ACCURACY



FASTER SEARCH SPEEDS



ENHANCED COMPATIBILITY



GREATER CONVENIENCE

DEVELOPMENT HISTORY

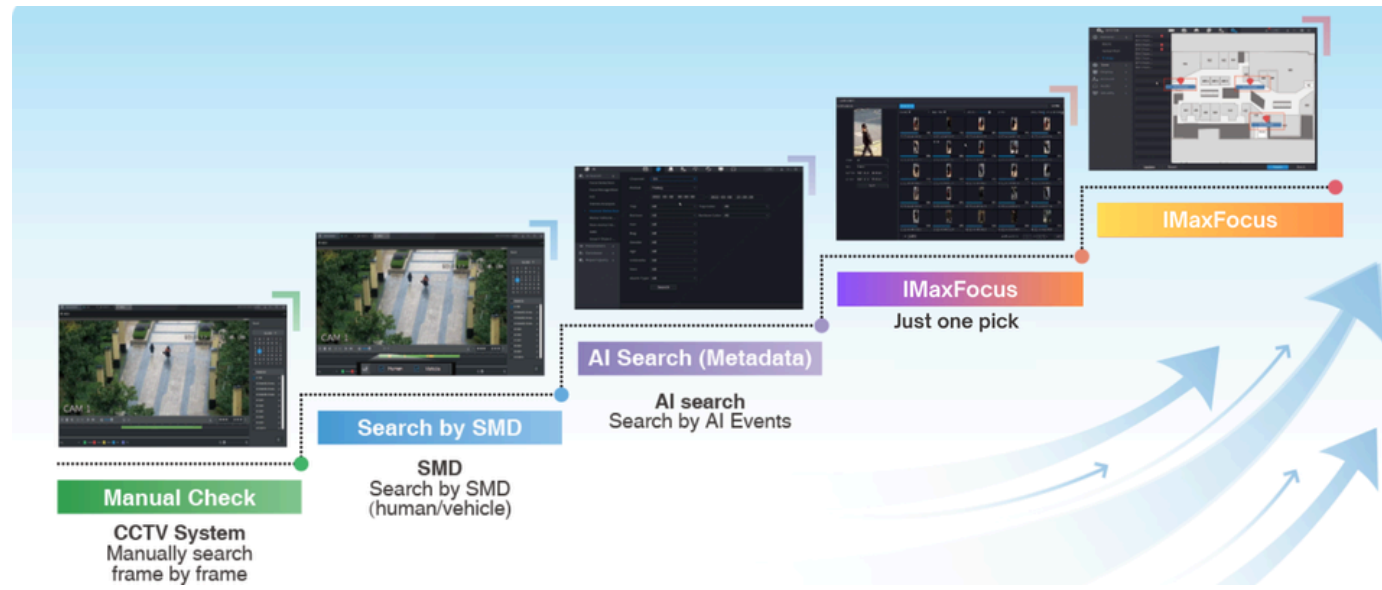

HIGHLIGHT

- Quickly and Accurate Locate Target**
 iMaxFocus enables rapid target identification using multiple pre-search attributes, and integrates intrusion detection with IVS self-learning technology.
- Better Compatibility**
 iMaxFocus by NVR supports AI, is compatible with both third-party and iMaxCamPro cameras, and lowers thresholds and costs. It connects with external platforms through CGI/SDK, providing enhanced flexibility.
- Easily Trackable**
 iMaxFocus supports searching for the movement trajectories of targets on the map and allows batch management of search results.
- Rich Search Types**
 iMaxFocus supports several types of search targets, including not only humans and vehicles, but also human faces and animals.

QUICKLY AND ACCURATELY LOCATE TARGET

Pre-search by Intrusion or Tripwire

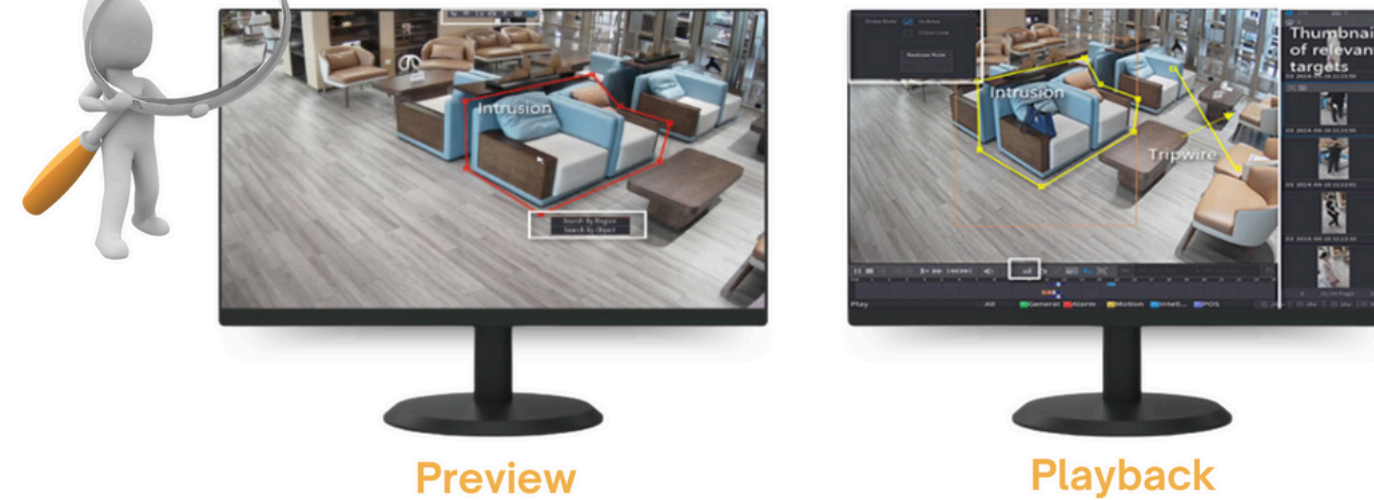

iMaxFocus offers advanced pre-search capabilities through intrusion detection and tripwire functionality. This feature allows users to swiftly pinpoint any targets that have entered the designated area. By clicking on the thumbnails, users can quickly lock onto the target and activate iMaxFocus.

Pre-search by Attributes



Before utilizing iMaxFocus, identifying the target's exact location can be crucial. However, in certain situations, users may lack specific details about when and where the target appeared, only having some known characteristics. To tackle this issue, iMaxFocus now incorporates attribute-based pre-search functionality. This allows users to filter targets based on available attributes, enabling them to efficiently search for matches that align with the known information.

TYPICAL SCENARIOS

LOSS OF PROPERTY

Ensuring property safety is crucial in everyday life. When loss occurs, it's essential to swiftly assess the situation, determine the extent of the damage, and work to recover the missing items. The Intrusion Pre-search feature can assist in promptly locating video footage related to the lost property.



LOCATE THE ROBBER

In a narrow passageway with limited foot traffic, ensuring safety can be challenging. Quick monitoring and awareness of potential dangers are essential. The Pre-search by Attributes feature helps identify targets swiftly, and the Target Track Query allows us to locate them quickly, preventing further harm or loss.



PET MONITORING

Pets often jump and run around the house when their owners are away. With this solution, pet owners can keep track of their pets' locations while they're not home. Users can also save daily videos of their pets for later viewing.

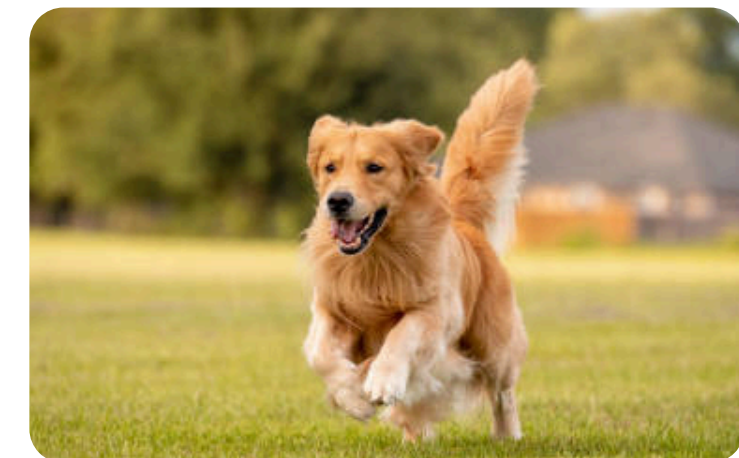

EASY OPERATION JUST ONE CLICK!



RICH SEARCH TYPES



Newly Supports Animal Search

iMaxFocus enables target searches for individuals, vehicles, and animals. With its accurate detection and tracking features, it serves as an excellent solution for improved security and surveillance, accommodating various applications effectively.

Human Search



Animal Search



Vehicle Search

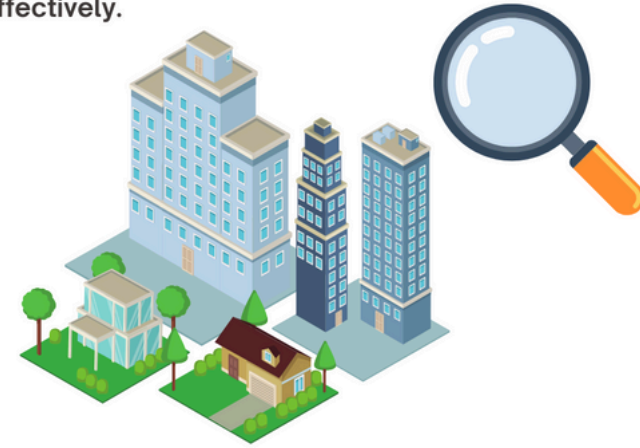

Search with Face Recognition

iMaxFocus can be activated alongside facial recognition on the NVR5-XI or NVR6-XI. When both features are operational, the system can identify and monitor individuals displaying suspicious behavior. If a recognized individual returns to the area, the system promptly alerts security personnel using facial recognition, significantly enhancing overall safety and security.



Enable Face Recognition
Enabled by default.
Users don't need to configure it.



Show detected human targets or faces



Pick human target



Pick human face

VALUE

ALARMS

With NVR, it can filter block-list face for early warning and identify VIP.

SEARCH

With NVR, it can help users search target based on face attribute.

STATISTICS

It can provide users with statistics on face to do data analysis.

GENDER >>

<< AGE

GLASSES >>

<< EXPRESSION

BEARD >>

<< MASK



FACE ATTRIBUTE

APPLICATION

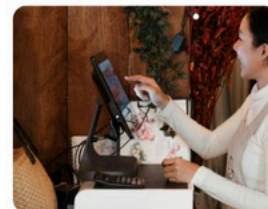

RETAIL



FACTORY ENTRANCE

CAPACITY

Detection accuracy rate: up to **98%**
Face detection capability: **32** faces/frame
Push image speed: **6-8** faces/second

MULTI-INTELLIGENT FUNCTIONS: HEAT MAP

ORIGINAL MAP



HEAT MAP

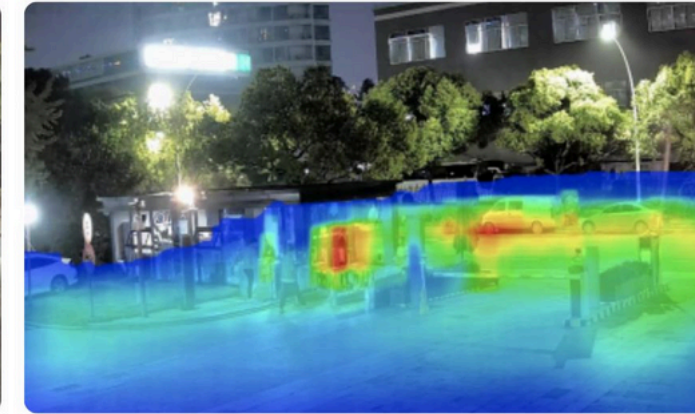

VALUE



ACCURATE TARGET DETECTION

Accurately detect the location and strand time of personnel and provide basic data



BUSINESS ANALYSIS

Export accurate data reports for business analysis



RISK MANAGEMENT

Focus on high population density area and give response timely

APPLICATION



RETAIL



OUTDOOR SPACE

EASILY TRACKABLE



Target Track Query

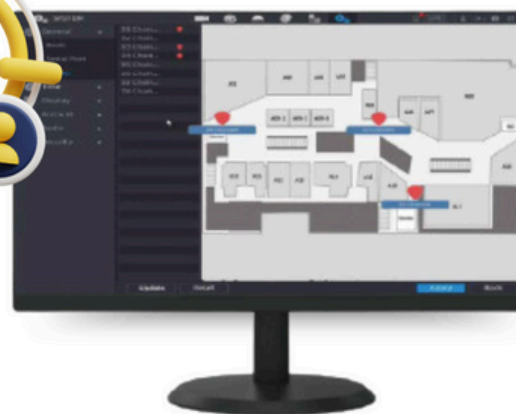

Users can upload maps and move cameras to its locations



When using iMaxFocus, a trajectory map of the target can be generated on the map

MULTI-INTELLIGENT FUNCTIONS: SMART OBJECT DETECTION

Smart Object Detection uses deep learning algorithm to focus on detection of objects such as boxes and bags. It effectively filters out interference caused by light, animals and other irrelevant objects. It also provides customers with accurate alarm information and reduced false alarms.

VALUE



ACCURATE TARGET DETECTION

Accurately detect the location and strand time of personnel and provide basic data



BUSINESS ANALYSIS

Export accurate data reports for business analysis



RISK MANAGEMENT

Focus on high population density area and give response timely

APPLICATION



STATION PLATFORM

CAPACITY

- ACCURACY RATE UP TO **90%**
- OBJECT TYPE UP TO **4** KINDS
- TARGET CAPTURING UP TO **100** OBJECTS/SEC
- AREA RULES UP TO **8** RULES

BETTER COMPATIBILITY



iMaxFocus by NVR

iMaxFocus is compatible with AI through NVR, allowing integration with third-party cameras as well as iMaxCamPro standard cameras. This capability not only simplifies usage but also helps to minimize installation costs.

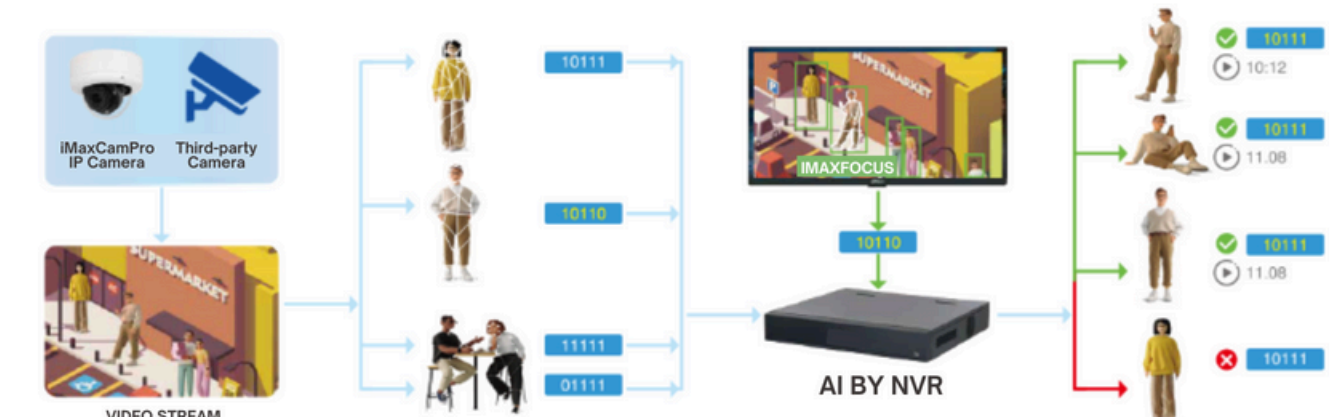

INCLUSIONS SPECIFICATIONS

DIMENSIONS (MM (INCH))

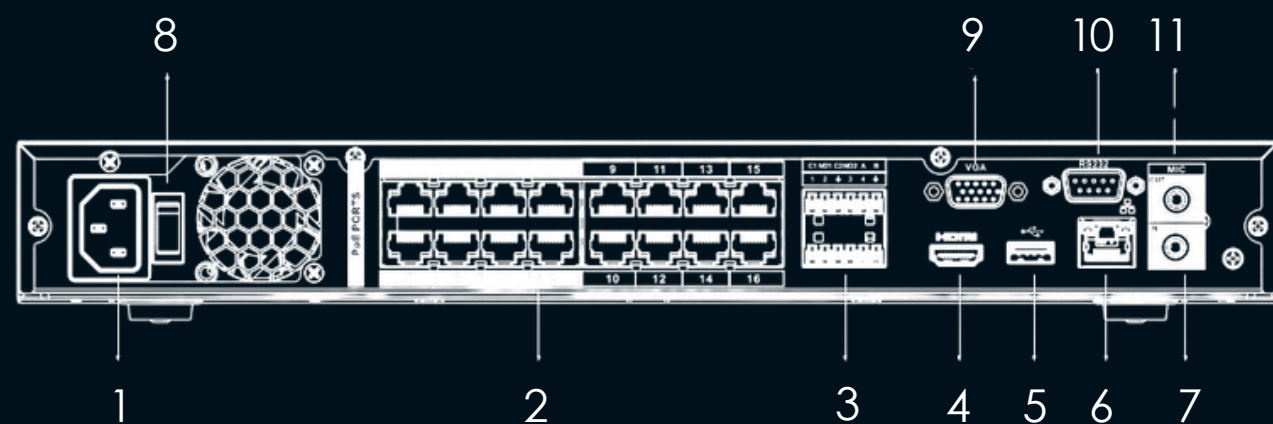
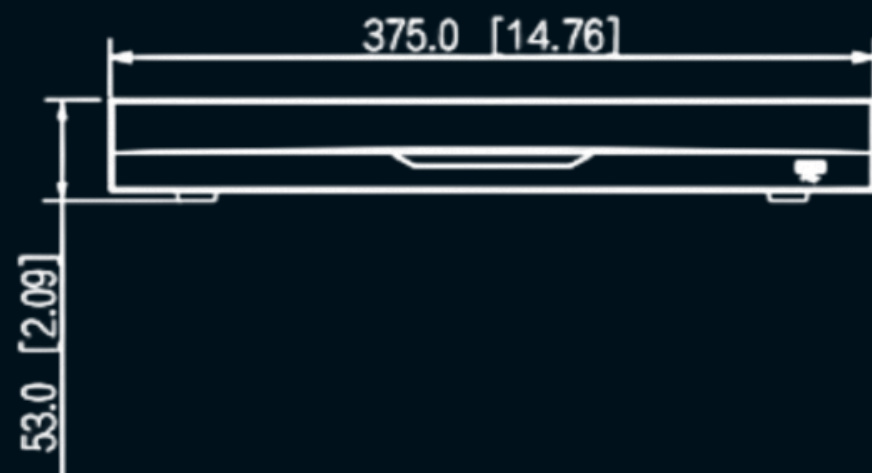

16 CHANNEL 12MP 2X SATA PORTS NVR

NETWORK VIDEO RECORDER FEATURES:

- SMART H.265+/H.265/SMART H.264+/H.264/MJPEG DECODING FORMAT.
- 32-CHANNEL 1080P SELF-ADAPTIVE DECODING CAPABILITY.
- MAX. 384 MBPS INCOMING/RECORDING/OUTGOING BANDWIDTH.
- AI BY RECORDER: 2-CHANNEL FACE DETECTION AND RECOGNITION, 4-CHANNEL PERIMETER PROTECTION, AND 8 CHANNEL SMD PLUS.
- AI BY CAMERA: FACE DETECTION AND RECOGNITION, PERIMETER PROTECTION, SMD PLUS, METADATA, ANPR, AND PEOPLE COUNTING.
- SECURITY BASELINE 2.3.



SKU: NVR502A-16-16P-EI

- | | |
|---------------------------|----------------|
| 1 POWER INPUT | 2 POE PORTS |
| 3 ALARM IN/OUT | 4 HDMI PORT |
| 5 USB PORT | 6 NETWORK PORT |
| 7 MIC IN, RCA CONNECTOR | 8 POWER SWITCH |
| 9 VGA PORT | 10 R2-232 PORT |
| 11 MIC OUT, RCA CONNECTOR | |



FUNCTIONS:

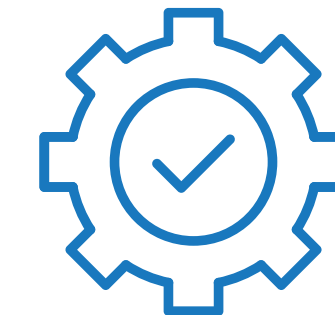

- ✓ PERIMETER PROTECTION
- ✓ FACE DETECTION
- ✓ FACE RECOGNITION
- ✓ HEAT MAP BY CAMERA
- ✓ ANPR BY CAMERA
- ✓ SMD PLUS





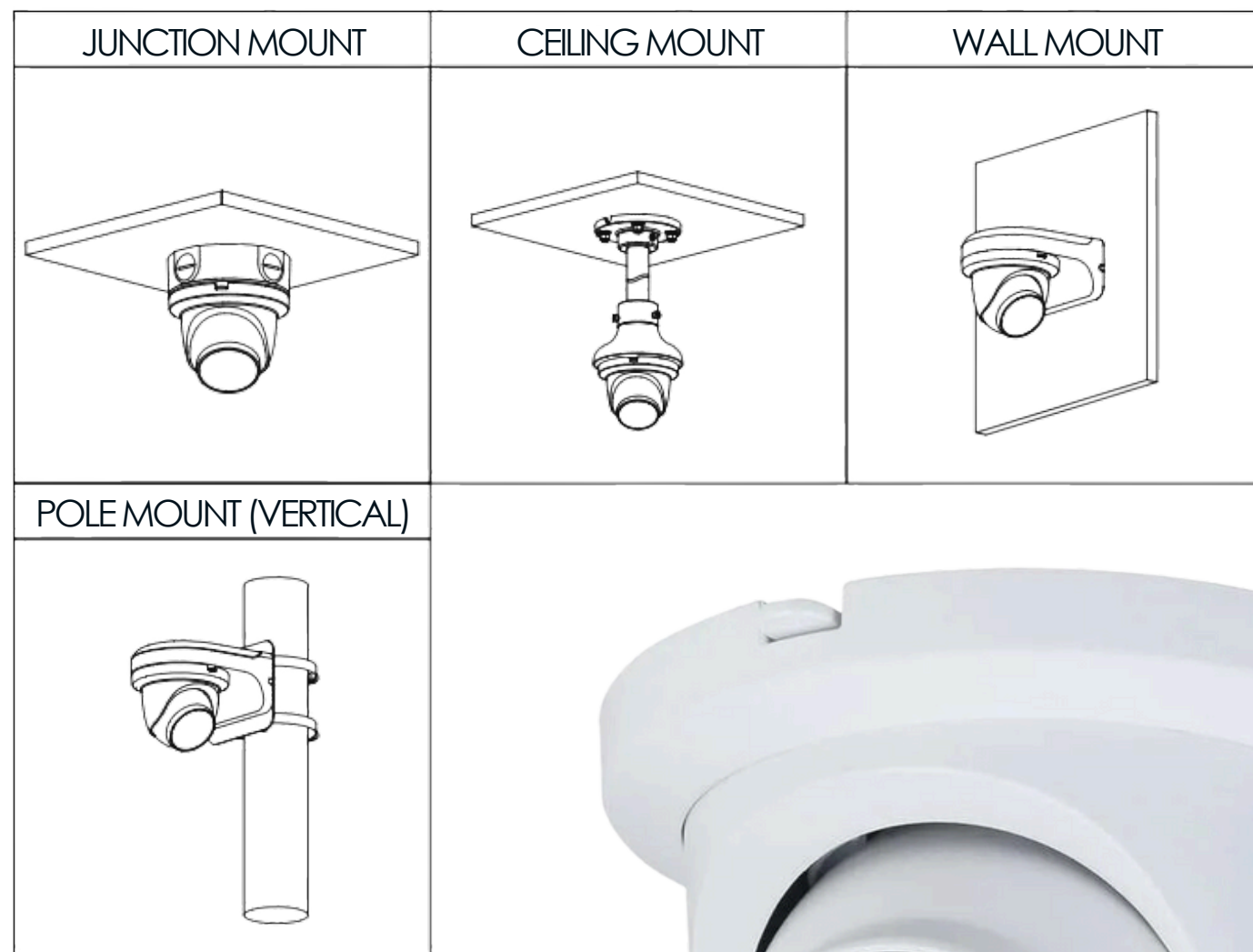

*THIS QR CODE WILL REDIRECT YOU TO THE PRODUCT SPECIFICATIONS PAGE OF THE ITEM LISTED ABOVE.



SKU: HNC5I342TM-IRASE-28-S3



FUNCTIONS:

-  **AI-POWERED IMAGE**
-  **FACE DETECTION**
-  **SMART SOUND DETECTION**
-  **PERIMETER PROTECTION**
-  **PEOPLE COUNTING**
-  **PROTECTION (IP67, WIDE VOLTAGE)**
-  **VIDEO METADATA**

4MP IPC TURRET 2.8MM FIXED SECURITY CAMERA

SECURITY CAMERA FEATURES:

- 4-MP 1/1.8" CMOS IMAGE SENSOR, LOW LUMINANCE, AND HIGH DEFINITION IMAGE.
- OUTPUTS MAX. 4 MP (2688x1520) @25/30FPS
- BUILT-IN IR LED, AND THE MAX. ILLUMINATION DISTANCE IS 50 M.
- ROI, SVC, SMART H.264+/H.265+, AI H.264/H.265, ENCODING AFTER FILTER, FLEXIBLE CODING, APPLICABLE TO VARIOUS BANDWIDTH AND STORAGE ENVIRONMENTS.
- ROTATION MODE, WDR, 3D NR, HLC, BLC, DIGITAL WATERMARKING, APPLICABLE TO VARIOUS MONITORING SCENES.
- WITH DEEP LEARNING ALGORITHM, IT SUPPORTS: VIDEO METADATA, SMART SOUND DETECTION, IVS, FACE DETECTION, SMART OBJECT DETECTION, AND PEOPLE COUNTING, ETC.
- ALARM: 1 IN, 1 OUT; AUDIO: 1 IN, 1 OUT; SUPPORTS MAX. 512 GB MICRO SD CARD, BUILT-IN MIC.
- 12 VDC/POE POWER SUPPLY; EPOE.
- IP67 PROTECTION.
- SMD 3.0.

*THIS QR CODE WILL REDIRECT YOU TO THE PRODUCT SPECIFICATIONS PAGE OF THE ITEM LISTED ABOVE.



INCLUSIONS SPECIFICATIONS

DIMENSIONS (MM (INCH))

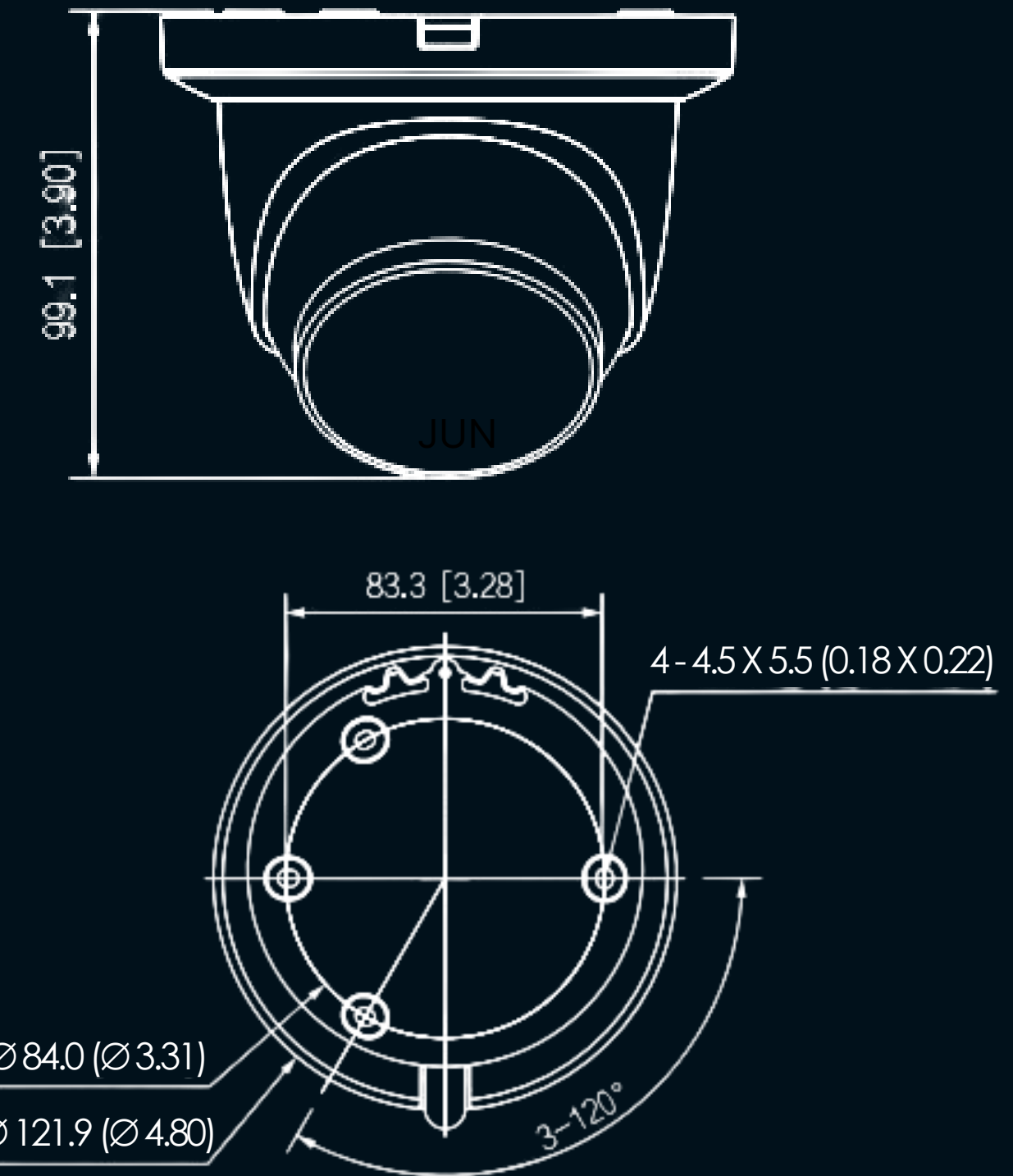

4MP

4K
ULTRA HD

16CH



IMAX FOCUS
BY IMAXCAMPRO

Contact Us



28202 Cabot Rd. #300 Laguna Niguel,
California, United States. 92677



Phone: 1-888-211-2288 - FAX: 949-503-0177
Local Phone: 949-305-6550



support@worldeyecam.com



www.worldeyecam.com

