



Esprit® SE Series Positioning System



**ES40/ES41
ES40P/ES41P**

Contents

Important Safety Instructions	8
Important Notices	9
Regulatory Notice	9
Description	10
ES40/ES41 Esprit SE Series with IOP	10
Models	10
ES40PC/ES41PC Esprit SE Series with Pressurized IOC	10
Models	10
Installation	11
Optional TXB Series Translator Board Installation	14
How to Remove the Pan/Tilt Cover	14
How to Reinstall the Pan/Tilt Cover	15
Operation	16
Power-Up Display	16
Quick Operation Guide	16
Quick Configuration Guide	16
Pan/Tilt Functions	17
Wiper	17
Preset 95: Accessing Main Menu	17
CM6700/CM6800	17
KBD200A/KBD300A: Direct Mode Only	17
CM9500	18
CM9740/CM9760/CM9770/CM9780	18
KBD4000/KBD4002	18
MPT9500	18
NET300/NET350/NET4001A	18
Endura Workstation	18
VCD5000	18
Digital Sentry® System Software	19
Digital Sentry DS ControlPoint	19
DVR5100	19
DX4100/DX4500/DX4600/DX8100	19
Menu Tree	20
Language	22
System Information	23
DIP Switch Information	23
Display Setup	24
Label Positions	25
Settings	26
Camera	26
Type of Lighting	26
Auto Focus	26
PT Focus Lock	27
Zoom Limit	27
Zoom Speed	27
Low Light Limit	27
IR Cut Filter	28
Advanced Camera Settings	29
Shutter Speed	29

AGC Limit	29
Auto Iris	29
Auto Sharpness	30
Auto White Balance	30
Backlight Compensation	30
Electronic Image Stabilization	30
Wide Dynamic Range	30
Low Lux Noise Reduction	31
Video Level	31
Field Align	31
Low Light Sharpness	31
Minimum Focus Distance	32
Zoom Focus Trace	32
Motion Settings	32
Proportional Pan	32
Park Time	32
Scan Speed	33
Preset Freeze Frame	33
Limit Stops	33
Azimuth Zero	34
Auto Tracking	34
Auto Tracking	34
Display Setup	34
Sensitivity	35
Start Time	35
Zoom	35
Lost Action	35
Return	35
Power Up	35
Power Up Action	35
Line Sync	36
Presets	37
Predefined Presets	37
Configuring a Preset	38
Creating an Action Preset	39
Motion Detection	40
Edit Schedule	41
Patterns	42
Zones	43
Window Blanking	44
Edit Schedule	45
Reverse	45
Clear Window	45
Blank All Above/Blank All Below	46
Aux	47
Wiper	47
Edit Schedule	48
Title Text	48
Alert	49
Repeat	49
Ack Action	49
Activate Aux	50
Current Reading	50
Reset Alert	50
Clear	51
Password	51
Clock	52
Event	54
Event Type	54

Event Label	55
Edit Event Label	55
Edit Event	55
Clear Event	56
List Event	56
Holiday	56
Edit Holiday	56
Clear Holiday	57
List Holidays	57
Scheduled Events	58
Reset, Cycle Power, Reboot	59
Reset Camera	59
Cycle Camera Power	59
Reboot Device	59
Software/Language File Upload	60
Troubleshooting	61
Maintenance	62
Specifications	63
Appendix A	65
Switch Settings	65
SW1: Receiver Address	65
SW2 Switch 1: AD-32 Preset System	65
SW2 Switch 2: CM9502 Setting	65
SW2 Switch 3: Control System Compatibility	65
SW2 Switches 4 and 5: Serial Port Settings	66
SW2 Switches 6 to 8: Baud Settings	66
Appendix B	67

List of Illustrations

- 1 Removing the Transformer Module 11
- 2 Attaching the Base to a Mount 12
- 3 Reinstalling the Transformer Module 12
- 4 Wiring AUX 2 13
- 5 Attaching the Pan/Tilt to the Base 13
- 6 DIP Switches 14
- 7 Removing the Pan/Tilt Cover 14
- 8 Properly Seating the Pan/Tilt Covers 15
- 9 Reinstalling the Pan/Tilt Cover 15
- 10 Wide Dynamic Range Settings 31
- 11 Motion Detection Areas 41
- 12 Window Selection Tool 44
- 13 Window Blanking 45
- 14 Window Blank Tilt Angles 46
- 15 Default Switch Settings 65

List of Tables

- A Low Light Limit Settings27
- B Presets for American Dynamics Controllers38
- C Window Blank Settings46
- D Baud Settings66
- E Switch Settings for SW1 Pelco P-Type Control67
- F Switch Settings for SW1 Pelco D-Type Control68

Important Safety Instructions

1. Read these instructions.
2. Keep these instructions.
3. Heed all warnings.
4. Follow all instructions.
5. Do not block any ventilation openings. Install in accordance with the manufacturer's instructions.
6. Do not install near any heat sources such as radiators, heat registers, stoves, or other apparatus (including amplifiers) that produce heat.
7. Only use attachments/accessories specified by the manufacturer.
8. Use only with the cart, stand, tripod, bracket, or table specified by the manufacturer, or sold with the apparatus. When a cart is used, use caution when moving the cart/apparatus combination to avoid injury from tip-over.
9. Refer all servicing to qualified service personnel. Servicing is required when the apparatus has been damaged in any way, such as power-supply cord or plug is damaged, liquid has been spilled or objects have fallen into the apparatus, the apparatus has been exposed to rain or moisture, does not operate normally, or has been dropped.
10. Installation should be done only by qualified personnel and conform to all local codes.
11. Unless the unit is specifically marked as a NEMA Type 3, 3R, 3S, 4, 4X, 6, or 6P enclosure, it is designed for indoor use only and it must not be installed where exposed to rain and moisture.
12. Use only installation methods and materials capable of supporting four times the maximum specified load.
13. Use stainless steel hardware to fasten the mount to outdoor surfaces.
14. To prevent damage from water leakage when installing a mount outdoors on a roof or wall, apply sealant around the bolt holes between the mount and mounting surface.
15. AN ALL-POLE MAINS SWITCH with a contact separation of at least 3 mm in each pole shall be incorporated in the electrical installation of the building.
16. A readily accessible disconnect device shall be incorporated in the building installation wiring.

CAUTION: These servicing instructions are for use by qualified service personnel only. To reduce the risk of electric shock do not perform any servicing other than that contained in the operating instructions unless you are qualified to do so.

Only use replacement parts recommended by Pelco.

After replacement/repair of this unit's electrical components, conduct a resistance measurement between the line and exposed parts to verify the exposed parts have not been connected to the line circuitry.

The product and/or manual may bear the following marks:



This symbol indicates that dangerous voltage constituting a risk of electric shock is present within this unit.



This symbol indicates that there are important operating and maintenance instructions in the literature accompanying this unit.



WARNING: HAZARDOUS MOVING PARTS. KEEP FINGERS AND OTHER BODY PARTS AWAY.

CAUTION:
RISK OF ELECTRIC SHOCK. DO NOT OPEN.

Important Notices

REGULATORY NOTICE

This device complies with Part 15 of the FCC Rules. Operation is subject to the following two conditions: (1) this device may not cause harmful interference, and (2) this device must accept any interference received, including interference that may cause undesired operation.

RADIO AND TELEVISION INTERFERENCE

This equipment has been tested and found to comply with the limits of a Class B digital device, pursuant to Part 15 of the FCC Rules. These limits are designed to provide reasonable protection against harmful interference in a residential installation. This equipment generates, uses, and can radiate radio frequency energy and, if not installed and used in accordance with the instructions, may cause harmful interference to radio communications. However there is no guarantee that the interference will not occur in a particular installation. If this equipment does cause harmful interference to radio or television reception, which can be determined by turning the equipment off and on, the user is encouraged to try to correct the interference by one or more of the following measures:

- Reorient or relocate the receiving antenna.
- Increase the separation between the equipment and the receiver.
- Connect the equipment into an outlet on a circuit different from that to which the receiver is connected.
- Consult the dealer or an experienced radio/TV technician for help.

You may also find helpful the following booklet, prepared by the FCC: "How to Identify and Resolve Radio-TV Interference Problems." This booklet is available from the U.S. Government Printing Office, Washington D.C. 20402.

Changes and modifications not expressly approved by the manufacturer or registrant of this equipment can void your authority to operate this equipment under Federal Communications Commission's rules.

This Class B digital apparatus complies with Canadian ICES-003.

Cet appareil numérique de la classe B est conforme à la norme NMB-003 du Canada.

Description

ES40/ES41 ESPRIT SE SERIES WITH IOP

The ES40/ES41 Esprit® SE Series combines a receiver, pan/tilt, enclosure, and integrated optics package (IOP) in a single, easy-to-install system. The integrated optics package contains an auto-focus camera and lens module with configurable features.

The devices are available with an input voltage of 24 VAC or with a selectable power source of 120/230 VAC. The Esprit SE Series devices are constructed of lightweight aluminum and have a heater, window defroster, sun shroud, and insulation blanket.

MODELS

ES4036	High resolution, color/black-white camera with infrared cut filter, electronic image stabilization, and 432X zoom (36X optical zoom and 12X digital zoom)
ES4136	Same as ES4036, except supplied with window wiper

Model Numbers

Model		Format	Pedestal Mount		Wall Mount	
			24 VAC	120/230 VAC	24 VAC	120/230 VAC
36X Color/B-W	Standard	NTSC	ES4036-2N	ES4036-5N	ES4036-2W	ES4036-5W
		PAL	ES4036-2N-X	ES4036-5N-X	ES4036-2W-X	ES4036-5W-X
	With Wiper	NTSC	ES4136-2N	ES4136-5N	ES4136-2W	ES4136-5W
		PAL	ES4136-2N-X	ES4136-5N-X	ES4136-2W-X	ES4136-5W-X

ES40PC/ES41PC ESPRIT SE SERIES WITH PRESSURIZED IOC

The ES40PC/ES41PC Esprit SE Series is designed to protect camera optics and electronics from moisture and airborne contaminants. The devices feature a receiver, pan/tilt, enclosure, and a pressurized integrated optics cartridge (IOC). The integrated optics cartridge packages an auto focus camera, lens, heater, and sensors in a small, self-contained unit pressurized to 10 pound-force per square inch gauge (psig) with dry nitrogen.

MODELS

ES40P36	High resolution, color/black-white camera with infrared cut filter, electronic image stabilization, and 432X zoom (36X optical zoom and 12X digital zoom)
ES41P36	Same as ES40P36, except supplied with window wiper

Model Numbers

Model		Format	Pedestal Mount		Wall Mount	
			24 VAC	120/230 VAC	24 VAC	120/230 VAC
36X Color/B-W	Standard	NTSC	ES40P36-2N	ES40P36-5N	ES40P36-2W	ES40P36-5W
		PAL	ES40P36-2N-X	ES40P36-5N-X	ES40P36-2W-X	ES40P36-5W-X
	With Wiper	NTSC	ES41P36-2N	ES41P36-5N	ES41P36-2W	ES41P36-5W
		PAL	ES41P36-2N-X	ES41P36-5N-X	ES41P36-2W-X	ES41P36-5W-X

Installation

1. When installing the ES40/ES41 or ES40P/ES41P Esprit SE device, allow for sufficient clearance between the top of the unit and overhead obstructions. This will prevent interference when the enclosure is driven to its maximum elevation of 36 degrees.

 VALUES IN PARENTHESES ARE INCHES; ALL OTHERS ARE CENTIMETERS.

Position	Model	
	ES40	ES41
A	42.5 (16.6)	42.9 (16.9)
B	23.9 (9.4)	24.6 (9.7)
C	18.1 (7.1)	19.2 (7.6)
D	10.7 (4.2)	11.7 (4.6)

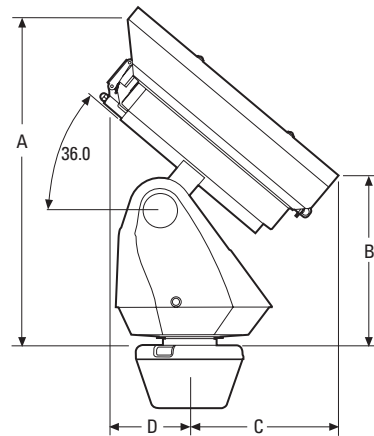

2. Remove the transformer module from the base of the device by loosening the four Phillips screws and lifting the module.

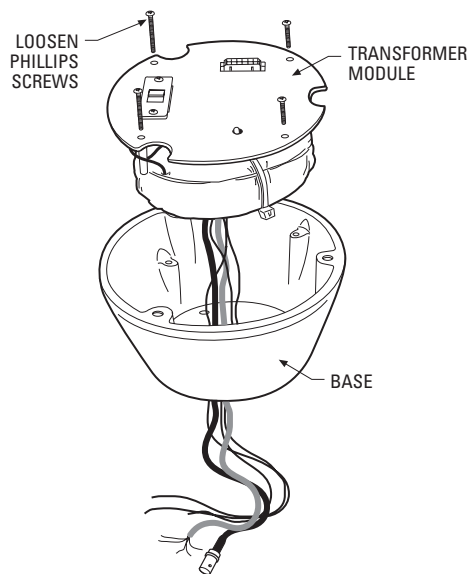



Figure 1. Removing the Transformer Module

3. Attach the base of the device to an Esprit mount (EWM or EPP):
 - a. Apply a drop of Loctite® thread compound (supplied) to each of the three mounting holes and 10-32 x 1/2-inch flathead screws (supplied).

 **WARNING:** Applying the Loctite thread compound is an important step in the installation process. Failure to apply Loctite to the mounting holes may increase the risk of damage to the unit

- b. Attach the base of the device to the mount using the three screws and washers.

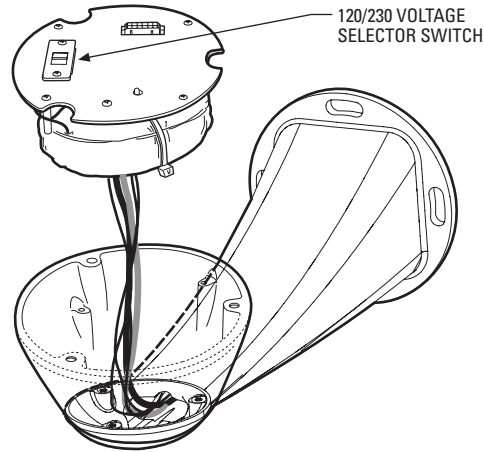

Figure 2. Attaching the Base to a Mount

- 4. Route the wires and cables through the center of the Esprit mount. Reinstall the transformer module into the base. The transformer module can be positioned in the mount base in only one orientation.

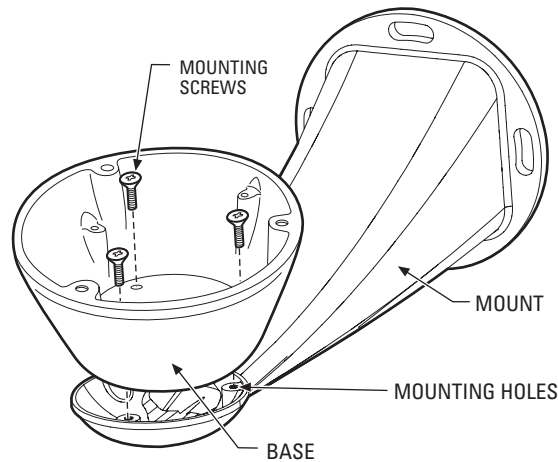

Figure 3. Reinstalling the Transformer Module

- 5. **Models with 120/230 VAC only:** Set the 120/230 voltage selector switch on the transformer to the appropriate voltage.
- 6. Connect wires and cables.
 - a. Connect to power. Use the two supplied clamp connectors to connect the AC line and neutral.

120/230 VAC	
Black wire	Input (AC Line)
White wire	AC Neutral
Green wire	Ground

24 VAC	
White wire	Input (AC Line)
White wire	AC Neutral
Green wire	Ground

- b. Connect the video coaxial cable to the BNC connector.
- c. Connect the wiring for a two-wire or four-wire control system. This step does not apply to Coaxitron® control systems.

Green wire	RX-
Red wire	RX+
Black wire	TX-
White wire	TX+

- d. Connect AUX 2 (optional).

Orange wire	AUX 2
Blue wire	AUX 2 COMMON

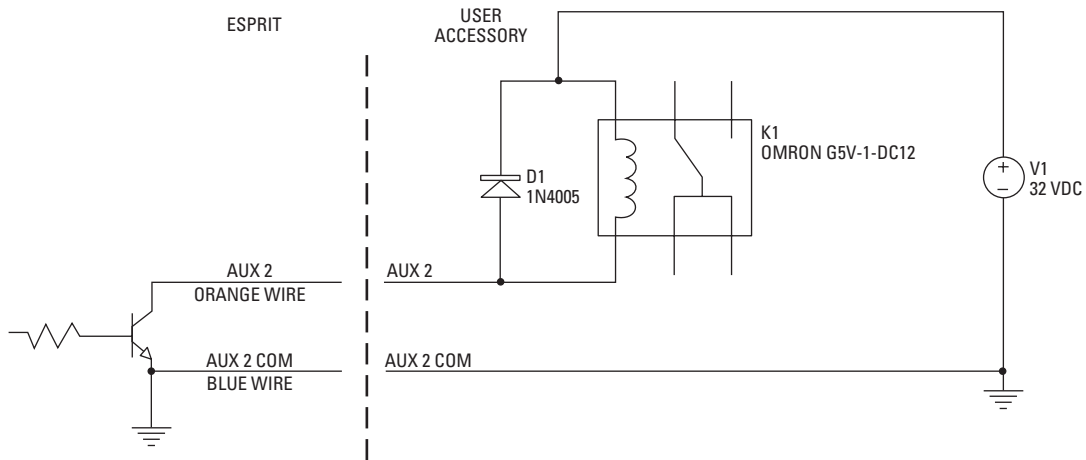

NOTE: CURRENT MUST NOT EXCEED 40 mA.

Figure 4. Wiring AUX 2

7. Install mount; refer to the installation manual supplied with the mount for instructions.
8. Turn on the power. If the red LED lights, turn off the power and proceed to the next step. If the red LED does not light, refer to *Troubleshooting* on page 61.
9. Plug the male Esprit system connector, located on the bottom of the pan/tilt, into the female Esprit system connector located on the transformer module. Align the pan/tilt part number with the alignment label of the base, and then attach the pan/tilt to the base with three 1/4-20 nuts and washers (supplied).

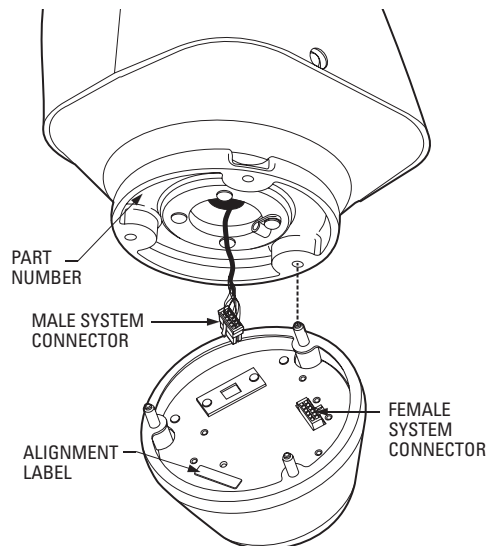

Figure 5. Attaching the Pan/Tilt to the Base

10. Set the receiver address and system baud rate by configuring DIP switches SW1 and SW2.

NOTE: Switch settings have no effect on Coaxitron control signals. The device will sense and automatically select input from Coaxitron control signals in either standard or extended mode.

To set the DIP switches:

- a. Remove the plug from the left cover of the pan/tilt. It is not necessary to remove the pan/tilt cover.
- b. Set the baud rate (SW1) and receiver address (SW2). For switch settings refer to the labels located on the inside lid of the housing or Table D on page 66 and Table E in the *Appendix A* on page 65.
- c. Replace the plug.

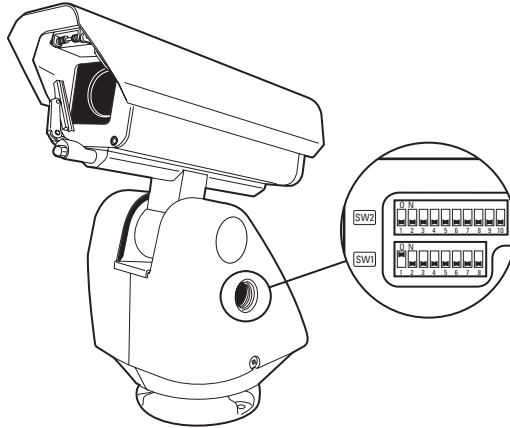

Figure 6. DIP Switches

11. Refer to *Operation* on page 16 and *Menu Tree* on page 20 for instructions on how to use your device.

OPTIONAL TXB SERIES TRANSLATOR BOARD INSTALLATION

Pelco's TXB Series translator boards allow controllers from other companies to communicate with the device.

To install a TXB Series board, remove the left cover of the pan/tilt. Once the cover is removed, refer to the manual supplied with the translator board to complete the installation.

HOW TO REMOVE THE PAN/TILT COVER

1. Unscrew the Phillips screw located on the left cover of the pan/tilt.
2. Remove and set aside the cover.

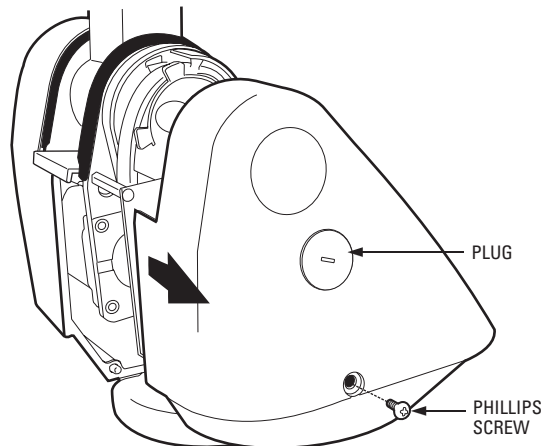

Figure 7. Removing the Pan/Tilt Cover

HOW TO REINSTALL THE PAN/TILT COVER

The pan/tilt covers must be properly seated and have a tight seal (all the way around) when installed.

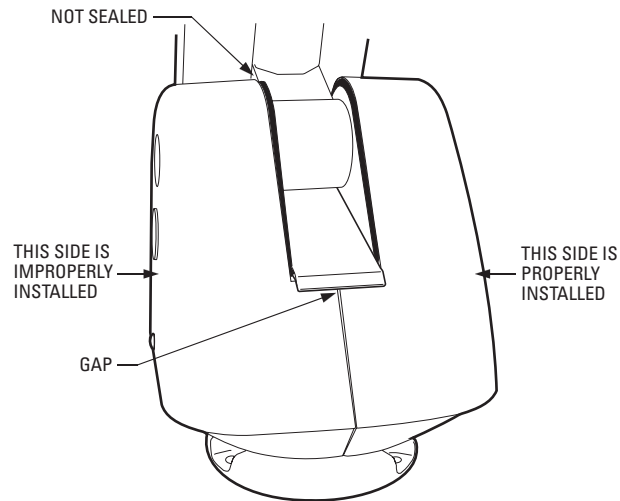

Figure 8. Properly Seating the Pan/Tilt Covers

To reinstall the pan/tilt cover, do the following:

1. Properly position the cover and slide it into place. The sides of the cover must fit under the front and back rain guards of the pan/tilt, and the top of the cover must seat against the lip of the top gasket.
2. Apply pressure and push down the top of the cover to align the fastener holes.
3. Insert the Phillips screw and tighten. Tighten until the screw will not turn.

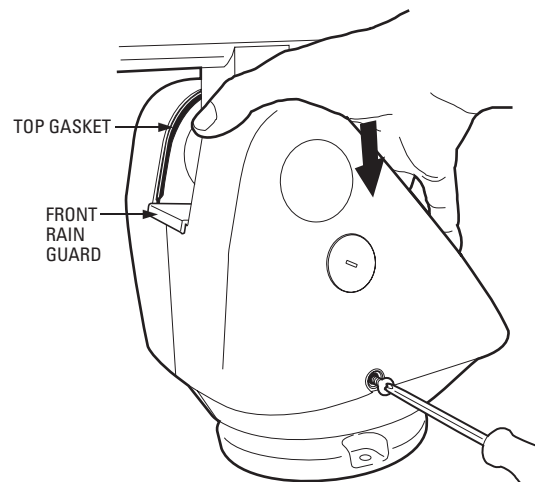

Figure 9. Reinstalling the Pan/Tilt Cover

Operation

POWER-UP DISPLAY

When the device is powered up, the selected protocol, revision number, and other information is displayed on the monitor. For example, the screen might show the following information:

```
PELCO ESPRIT SE
VERSION 2.50
D ADDRESS 1
P ADDRESS 2
COMM 9600,N,8,1

CONFIGURE DONE
=====
12345678 1234567890
SW1[-----] SW2[-----]
```

The information remains on the monitor until the device receives a command.

QUICK OPERATION GUIDE

Pan and Tilt	Move the joystick or press the direction keys left/right and up/down.
Zoom Far	To zoom far: <ol style="list-style-type: none">1. Press the Zoom Tele button or turn the joystick clockwise until zoom stops at the optical zoom limit.2. Release the button or joystick for one second.3. To continue zooming (digitally), press the button or turn the joystick clockwise again until you have the picture you want or reach the digital zoom* limit.
Zoom Wide	Press the Zoom Wide button or turn the joystick counterclockwise.
Scanning	Stop Scan Preset 96 Random Scan Preset 97 Frame Scan Preset 98 Auto Scan Preset 99
Presets	Refer to the documentation supplied with the control system.
Patterns[†]	Refer to the documentation supplied with the control system.
Zones	Refer to <i>Zones</i> on page 43 and to the documentation supplied with the control system.

QUICK CONFIGURATION GUIDE

1. Configure preset 95 to access the main menu (refer to *Preset 95: Accessing Main Menu* on page 17).
2. Use the joystick to position the cursor beside the menu selection.
NOTE: If your controller does not have a joystick, use the up or down key.
3. Press Iris Open, the submenu/cursor moves to the right.
4. Move the joystick up or down to view the selections.
5. Press Iris Open to enter the selection.
6. Press Iris Close to cancel the selection.

*Digital zoom magnifies the image electronically and the picture may appear pixilated. The larger the digital zoom limit the greater the reduction in resolution.

[†]The device cannot perform electronic zoom in a pattern. Optical zoom will operate in a pattern.

PAN/TILT FUNCTIONS

Controller Type	Pan (Capability: 360° Continuous Pan Rotation) [†]	Tilt (Viewing Range: +36° to -85°)
Fixed speed	Speed determined by controller	Speed determined by controller
Variable speed*	0.1 to 40° per second, depending on joystick and zoom positions	0.1 to 30° per second, depending on joystick and zoom positions
Turbo Mode*	100° per second	Does not affect the tilt speed
Preset Mode*	100° per second	30° per second

*80 kph (50 mph) wind-speed profile.

[†] If manual limit stops are set, "Pan Limit" appears on your monitor when a limit stop is reached (except when you are configuring or running a pattern). This does not apply to scan limit stops.

If the proportional pan mode is enabled (refer to *Proportional Pan* on page 32), the pan/tilt speeds will depend on the amount of zoom. At telephoto zoom settings, the pan/tilt speeds will be slower for a given amount of joystick deflection than at wide zoom settings. This keeps the image from moving too fast on the monitor when there is a large amount of zoom. This slowing does not happen when going to a preset but does occur in Turbo mode when high zoom is selected. The minimum pan/tilt speeds are 0.1 degree per second at full zoom.

WIPER

The ES41C Series features a window wiper to clear moisture from the enclosure glass. There are two modes of operation for the wiper: momentary and continuous. The wiper mode is easily set up through on-screen configuration (refer to *Wiper* on page 47).

To operate the wiper do the following:

Momentary mode: To operate the wiper one full cycle, press the AUX 1 button on your controller. Each press of the button operates the wiper one full cycle, even if the AUX 1 button is latching. If AUX 1 is latching, the first press will activate the wiper (open the latch). Pressing AUX 1 a second time closes the latch, but will not cycle the wiper. Press the AUX 1 key again to cycle the wiper.

Continuous mode: To operate the wiper press the AUX 1 button on your controller. The wiper will continue to operate until the AUX 1 button is pressed again or until the configured cycle is completed.

NOTE: (CM9740 and CM9760 matrix systems only) For the wiper to operate in continuous mode, the AUX 1 function in the camera file must be set to latching. If the AUX 1 camera file is not latching, the wiper will only operate in momentary mode, even if the Esprit wiper is configured for continuous operation. Refer to the operation manual supplied with the CM9740 or CM9760 matrix system for instructions.

PRESET 95: ACCESSING MAIN MENU

You can call up the main menu on your monitor by configuring (setting or creating) preset 95 (preset 28 in AD-32 preset mode).

Configuring preset 95 for Pelco's controllers varies according to the type of controller you are using. Instructions for configuring preset 95 are given below for various Pelco controllers.

CM6700/CM6800

1. Enter the number of the Esprit SE device and press the CAM key.
2. Enter 95 and hold the PRESET key for two seconds.
3. In the Edit Preset menu, go to SET and press the ACK key. The main menu appears.

KBD200A/KBD300A: Direct Mode Only

1. Enter 95.
2. Hold the PRESET key (approximately five seconds) until the main menu appears on the screen.

CM9500

1. Enter the number of the Esprit SE device and press the CAM key. The main menu appears.
2. Highlight SETUP in the main menu and press the SELECT key.
3. Highlight CAM in the Setup menu and press the SELECT key.
4. Highlight PRESET in the Camera menu and press the SELECT key.
5. Enter 95 and press the F1 key. The main menu appears.

CM9740/CM9760/CM9770/CM9780

1. Press the ESCAPE key to open the main menu. Select DEF. The Define submenu appears.
2. Enter your four-digit PIN *if this is your first time entering this mode*.
3. Enter 95 and select PRST. The main menu appears.
4. Select the Quit icon to return to the default menu.

KBD4000/KBD4002

1. Press the SPOT MONITOR key.
2. Enter 95, then hold the PRESET key (approximately five seconds) until the main menu appears on the screen.

MPT9500

Standard Coaxitron Mode

1. Enter 95 and press the PRESET SET key.
2. Position the asterisk in the YES row and press the F1 key. The main menu appears.

Extended Coaxitron or RS-485 Mode

1. Enter 95 and press the PRESET SET key.
2. Press the F2 key. The main menu appears.

NET300/NET350/NET4001A

1. Check the Set box.
2. Click the preset 95 button. The main menu appears.

ENDURA WORKSTATION

1. Right-click in the video pane of the Esprit SE device.
2. Click Preset and then click Select Preset.
3. Enter 95 and then click OK.

VCD5000

1. Enter 95 for the preset action. The shortcuts menu appears.
2. Press the Preset button on the KBD5000.

DIGITAL SENTRY® SYSTEM SOFTWARE

1. Click the PTZ tab.
2. Click the right or left arrows below the Go to Preset button until Go to Preset 95 appears on the button.
3. Click the Go to Preset 95 button. The main menu appears.

DIGITAL SENTRY DS CONTROLPOINT

1. Click the PTZ Controls icon. The PTZ Control tab appears below the PTZ video frame.
2. Click the up and down arrows to display 95 in the Preset Name text box.
3. Click the Call button. The main menu appears.

DVR5100

1. While in live view mode, select a video pane that is displaying video from a Esprit SE device.
2. From the Main menu, click Actions. The Actions menu appears.
3. From the Actions menu, click PTZ Operations. The PTZ Operations dialog box appears.
4. In the PTZ Operations dialog box, type **95** in the text box, and then click Presets. The main menu appears.

DX4100/DX4500/DX4600/DX8100

1. Click the PTZ button on the toolbar. The PTZ control appears.
2. Click the Program button on the PTZ control. The main menu appears.

Menu Tree

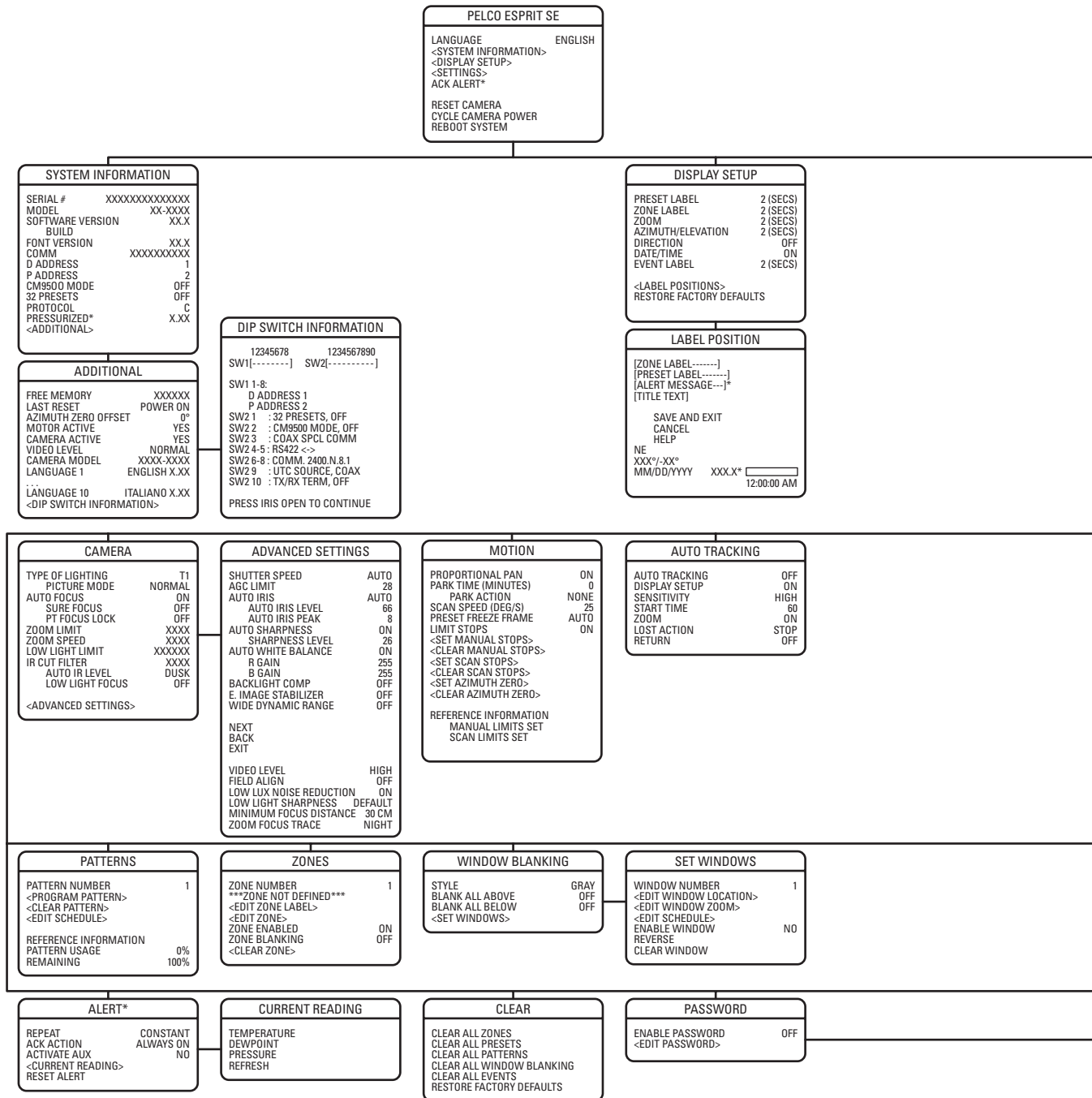

*This setting applies to pressurized devices only. Devices that are not pressurized will not display this menu item.

NOTE: The BACK and EXIT options do not appear in these menus due to space limitations. See the individual menus in this document for complete configurations.

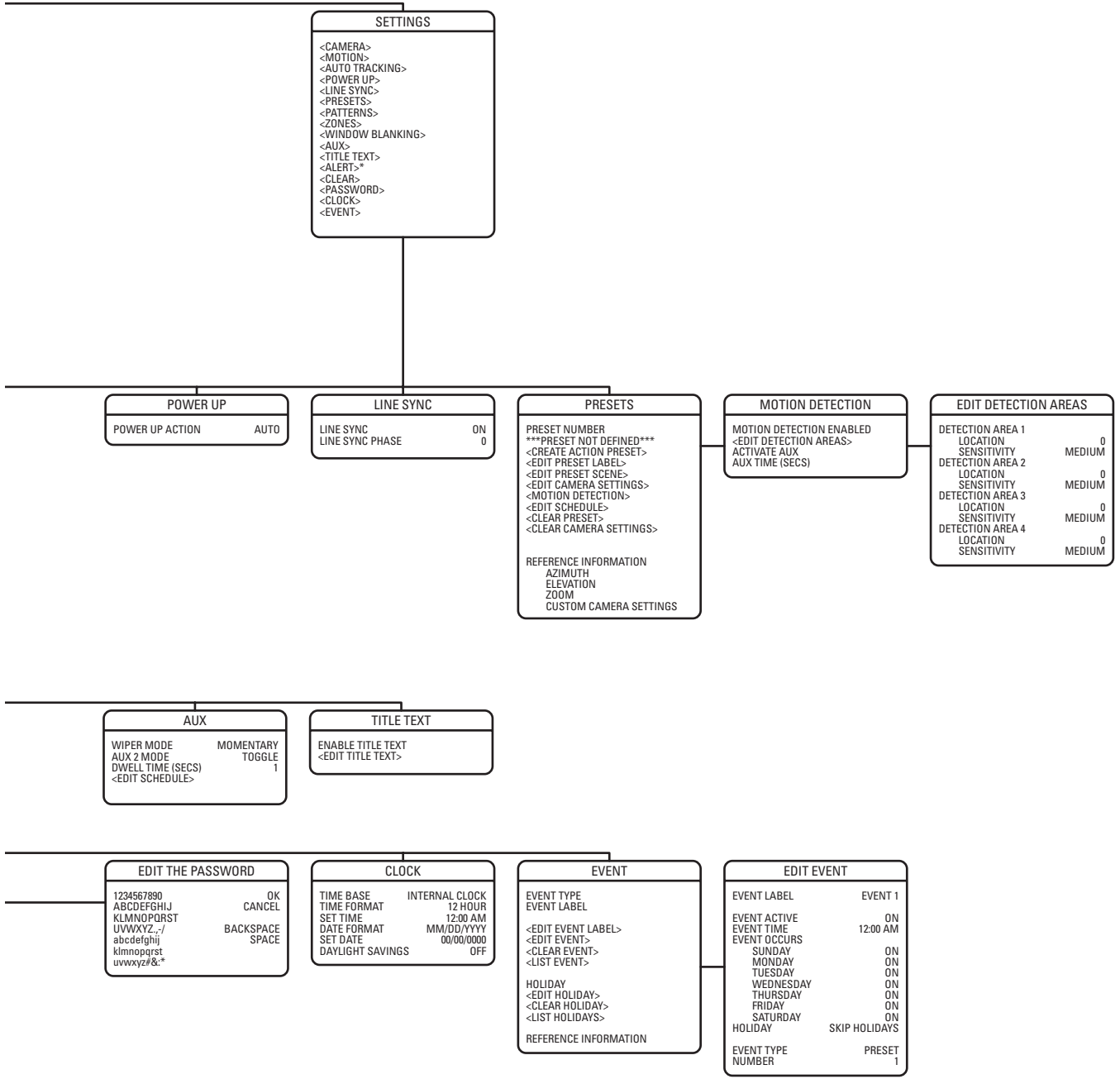

Language

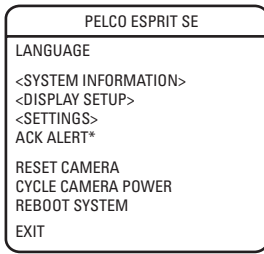

The language for the on-screen menus is selectable. Available languages include English, Spanish, French, German, Italian, Portuguese, Russian, Polish, Turkish, and Czech. The factory default language is English.

To change the display language:

1. Use the joystick to position the cursor beside LANGUAGE.
2. Press Iris Open. The cursor moves to the right, beside the current, selected language.
3. Move the joystick up or down to view the selections. Press Iris Open to enter the selection. All on-screen menus are changed to the selected language.

*This setting applies to pressurized devices only.

System Information

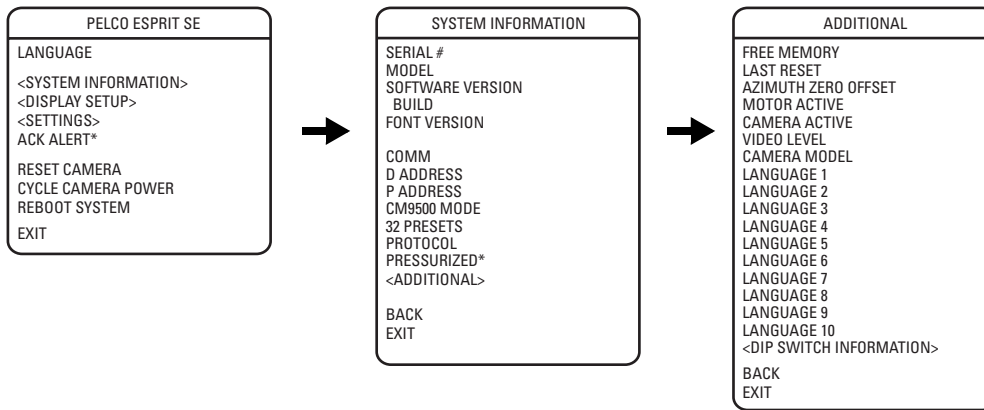

The System Information menu displays the model, software version, available memory, DIP switch information, and other diagnostic information. System settings cannot be changed using this menu; this information is for reference only.

Use the following steps to display the System Information menu:

1. Use the joystick to position the cursor beside SYSTEM INFORMATION.
2. Press Iris Open. The SYSTEM INFORMATION menu opens.

DIP SWITCH INFORMATION

The DIP Switch Information menu displays the current DIP switch settings. This provides a way to remotely view the DIP switch settings without removing accessing the device.

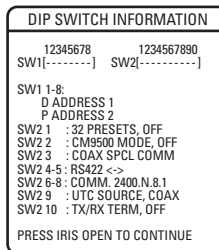

*This setting applies to pressurized devices only.

Display Setup

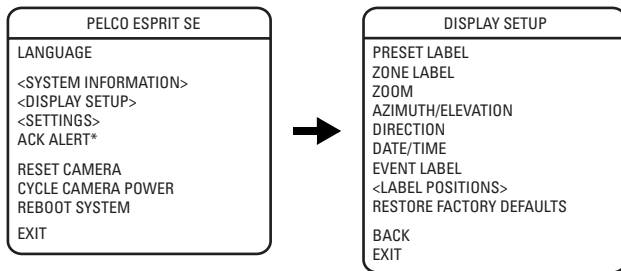

Display setup allows you to configure how labels are displayed on the monitor. The following labels are available:

PRESET LABEL: Identifies preset.

ZONE LABEL: Identifies zone.

ZOOM: Identifies the amount of magnification.

AZIMUTH[†]/ELEVATION[‡]: Amount of pan from zero degrees vertical and the amount of tilt from zero degrees horizontal.

DIRECTION: Displays compass direction.

DATE/TIME: Displays current date and time.

EVENT LABEL: Displays activated event.

A preset label is displayed when a preset is called. A zone label is displayed when the device moves into a zone. The zoom ratio label is displayed when zoom is activated. Azimuth/elevation and direction labels are displayed when pan/tilt is activated. An alarm message appears on the monitor when an alarm occurs. An event label appears on the monitor when an event occurs.

The following settings are available for each label except date and time:

OFF: Label is not displayed when activated.

CONSTANT: The label is continually displayed when activated.

2 SECONDS: The label is displayed for 2 seconds after activation.

5 SECONDS: The label is displayed for 5 seconds after activation.

10 SECONDS: The label is displayed for 10 seconds after activation.

The settings for date and time are ON or OFF.

*This setting applies to pressurized devices only.

[†]Azimuth is the pan angle from zero to 359 degrees.

[‡]Elevation is the tilt position from zero (horizon) to -90 degrees.

LABEL POSITIONS

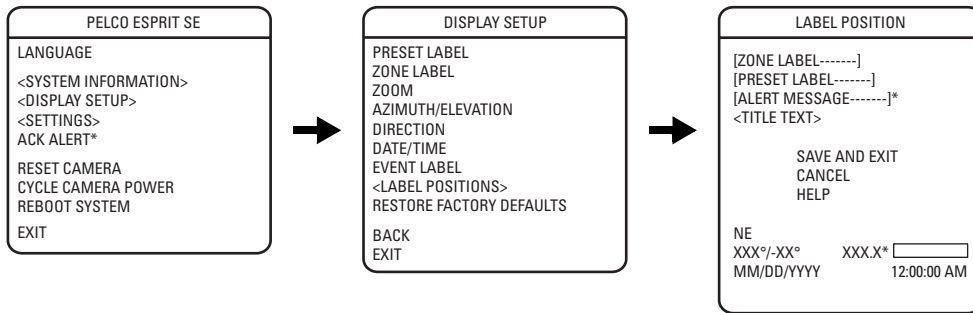

Labels can be placed anywhere on the monitor. This feature allows you to customize the appearance of your monitor screen.

The following labels are not set at fixed positions:

ZONE LABEL
PRESET LABEL
ZOOM RATIO - XXX.X*
AZIMUTH[†]/ELEVATION[‡] - XX°/-XX°
DIRECTION - NE
ALERT MESSAGE^{*§}
TITLE TEXT
EVENT LABEL
DATE/TIME

To set a label position:

1. Use the joystick to position the cursor beside a label.
2. Press Iris Open.
3. Use the joystick to move the label up, down, left, or right.
4. Press Iris Open.
5. Repeat steps 1 to 4 to position other labels.
6. Position the cursor next to Save and Exit. Press Iris Open to save settings and exit the menu.

*This setting applies to pressurized devices only.

[†] Azimuth is the pan angle from zero to 359 degrees.

[‡] Elevation is the tilt position from zero (horizon) to -90 degrees.

[§] The alert message is the warning displayed on the monitor if pressure, temperature, or dew point inside the device reaches unacceptable levels.

Settings

CAMERA

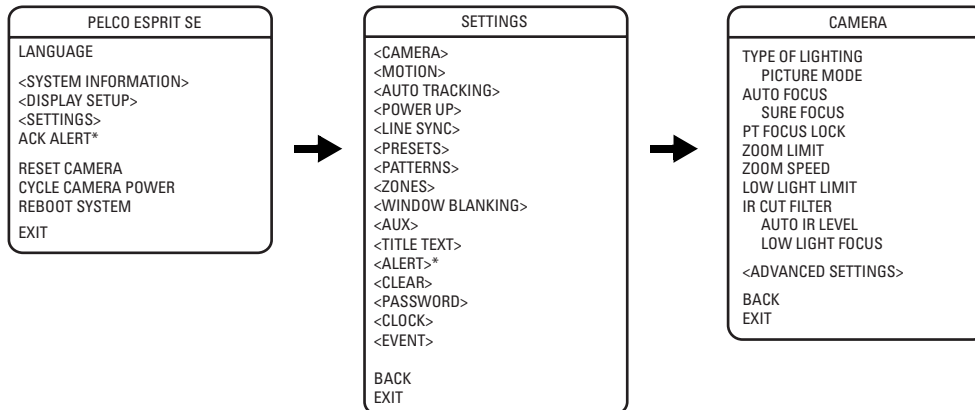

TYPE OF LIGHTING

Pelco has calibrated settings that optimize the white balance and the picture for several lighting conditions. There are two settings:

T1 (default): For use in outdoor applications.

T2: For use in indoor applications.

Picture Mode

Picture mode offers enhanced color and brightness depending on the scene.

Available settings are NORMAL (default) and ENHANCED. When picture mode is set to ENHANCED, the camera enhances colors and the overall picture.

NOTES:

- The scene on your monitor will darken temporarily when you change the picture mode setting.
- When Type Of Lighting is set to T1 and Picture Mode is set to Enhanced, and you change the setting for Type Of Lighting to T2, Picture Mode is no longer visible in the menu. When Type Of Lighting is returned to the T1 setting, Picture Mode becomes visible and is automatically reset to Normal.

AUTO FOCUS

Auto focus allows the lens to remain in focus during zoom-in, zoom-out, and motion functions.

There are two auto focus settings:

ON (default): If auto focus mode is set to ON, the camera will focus automatically when using pan, tilt, and zoom (PTZ) functions.

OFF: Focus is operated manually. To focus, press the Focus Far or Focus Near button on the controller.

Sure Focus

When sure focus is enabled and all PTZ motions are stopped, the camera will attempt to find a fixed focus position and lock to an object in the scene. If a focus lock is acquired or a specific amount of time has expired with no focus lock, the focus position remains fixed until PTZ is resumed.

NOTE: If auto focus is OFF, sure focus is disabled and hidden from the menu.

*This setting applies to pressurized devices only.

PT FOCUS LOCK

Pan/tilt (PT) focus lock holds the focus position of the lens during PTZ to maintain accurate focus between scenes, especially during the execution of presets and in low-light scenes. There are two settings:

ON: PT focus lock is enabled.

OFF (default): PT focus lock is disabled.

ZOOM LIMIT

Zoom limit allows the user to define a limitation on the amount of telephoto zoom. The settings vary depending on camera model.

The default setting is 70X. Cameras with 432X zoom (36X optical zoom and 12X digital zoom) can be set for 36X, 72X, 144X, 288X, 360X, or 432X.

ZOOM SPEED

Zoom speed allows the user to define the speed at which the device will go from full wide zoom to the optical zoom.

Available zoom settings:

HIGH: 3.2 seconds

MEDIUM (default): 4.6 seconds

LOW: 6.6 seconds

NOTE: When using the HIGH setting, the image may be out of focus until zooming stops.

LOW LIGHT LIMIT

Low light limit is the maximum duration, in fractions of a second, that the electronic shutter will remain open in low light conditions. The default setting is 2. Refer to Table A for available settings.

Table A. Low Light Limit Settings

Setting	Duration of Open Electronic Shutter
2 (default)	1/2 second
4	1/4 second
8	1/8 second
15	1/15 second
30	1/30 second
60	1/60 second

IR CUT FILTER

Esprit SE devices have two modes of operation: color, and black-white. You can increase sensitivity in low light conditions by switching to black-white mode (removing the IR cut filter). Color mode is preferred in normal lighting conditions.

The following are the settings for the IR cut filter:

OFF: Manual operation is controlled by preset 88 (filter IN) and 89 (filter OUT).

AUTO (default): Automatic operation is controlled by the auto IR level setting.

IN: Images are always displayed in color mode.

OUT: Images are always displayed in black-white mode.

NOTE: The IN and OUT settings are available when editing camera settings through the Camera and Presets menus (refer to *Camera* on page 26 and *Presets* on page 37).

Auto IR Level

The auto IR level is the light level at which the infrared filter switches IN or OUT.

Following are the available settings for the auto IR level:

DUSK (default): Approximately 6 lux (black-white); approximately 13 lux (color).

DARK: Approximately 0.1 lux (black-white); approximately 2 lux (color).

NOTES:

- If backlight compensation is ON and the IR cut filter switches OUT in normal lighting conditions, adjust the Auto IR Level to a darker setting. Refer to *Backlight Compensation* on page 30.
- *Low light* does not mean *no light*. Some type of illumination is required (street light, IR light, etc.). The camera is not sensitive to IR light when the IR cut filter is IN.

Low Light Focus

If you are using an IR illuminator, the low light focus feature of the camera can be tuned to correspond to the setting of the illuminator.

There are three low light focus settings:

OFF (default): Low light focus is not activated.

850NM: Low light focus is tuned to 850 nm (nanometers).

950NM: Low light focus is tuned to 950 nm.

ADVANCED CAMERA SETTINGS

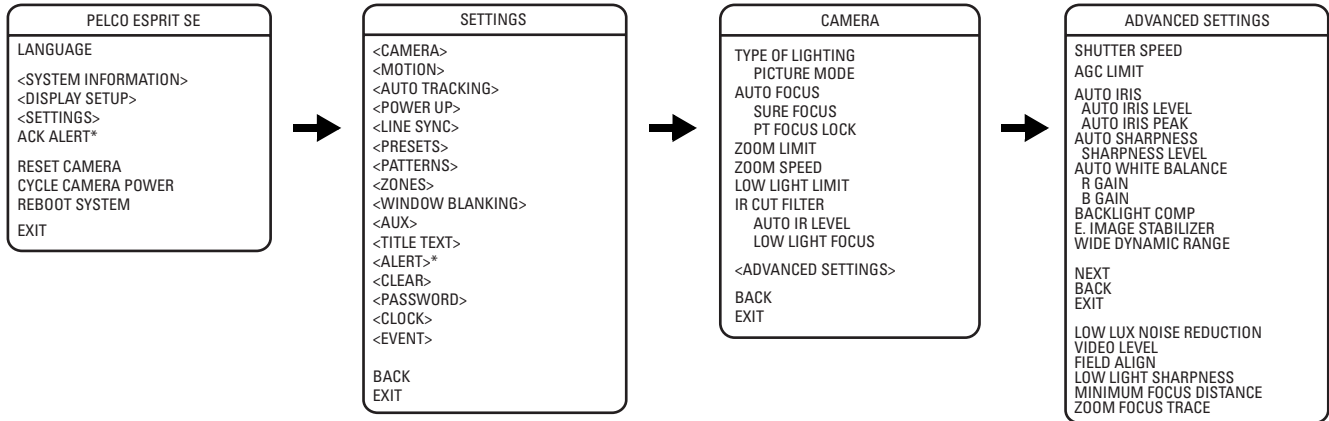

SHUTTER SPEED

Shutter speed is the duration of the electronic shutter. You can configure the shutter speed to operate automatically (Auto) or manually (Numeric Value).

AUTO (default): The electronic shutter speed is set automatically by the amount of light sensed by the camera.

NUMERIC VALUE: The device has several numerical shutter speed settings. The higher the number, the faster the electronic shutter.

The slowest shutter speed setting is $2 = 1/2$ second.

The fastest setting is $30,000 = 1/30,000$ second.

Increasing the shutter speed lowers the light sensitivity and reduces the streaking of fast moving objects.

Set the shutter speed to 100 if you are using an NTSC camera in a 50 Hz environment. This will eliminate any flicker that may occur in the picture.

AGC LIMIT

AGC limit allows users to adjust how the device balances AGC (automatic gain control) and electronic shutter in low light conditions. As scene lighting decreases, the device will automatically adjust, adding a mixture of AGC and slow shutter according to the AGC limit setting. AGC limit can be set between 0 and 40, with 40 applying maximum AGC before slow shutter. In contrast, setting AGC limit to 0 will force the system software to apply maximum slow shutter (as defined by the low light limit setting) before any AGC is applied. The default AGC settings vary depending on camera model.

NOTE: The maximum slow shutter that the device will achieve is $1/2$ second shutter (refer to *Low Light Limit* on page 27).

AUTO IRIS

Auto iris is the lens function that automatically opens and closes the iris in response to changing light conditions.

You can configure the auto iris to operate automatically or at a user-defined level.

OFF: Auto iris is disabled, and control is always manual.

AUTO (default): The iris is adjusted automatically to produce a constant video output as determined by the auto iris level setting.

If auto iris is in the auto mode, it will remain that way until the iris is manually opened or closed. The device will return to auto mode when it is panned or tilted more than 15 degrees.

Auto Iris Level

Auto iris level is the numeric value the auto iris uses to maintain the brightness level of the camera. Increase the value to brighten the scene. Decrease the value to darken the scene. This setting can be adjusted if the video level in the auto iris mode is too bright or too dark.

NOTE: If backlight compensation is ON, decrease the auto iris level setting.

*This setting applies to pressurized devices only.

Auto Iris Peak

Increasing the peak value will cause the auto iris circuit to react more to highlights or “peaks” in the picture. Decreasing this value will cause it to use the average video level to adjust the iris.

AUTO SHARPNESS

Auto sharpness enhances picture detail by increasing the aperture gain of the camera and sharpening the edges in the picture.

There are two settings:

ON (default): The camera automatically maintains a normal sharpness mode.

OFF: The sharpness of the picture is set manually by configuring the sharpness level. Sharpness level settings range from 0 to 63.

AUTO WHITE BALANCE

This feature automatically processes the viewed image to retain color balance over a color temperature range. The default setting for auto white balance is ON.

R GAIN: Adjusts the picture output in the red range. As you change the value, you will see the color change on your monitor.

B GAIN: Adjusts the picture output in the blue range. As you change the value, you will see the color change on your monitor.

BACKLIGHT COMPENSATION

If a bright backlight is present, the subjects in the picture may appear dark or as a silhouette. Backlight compensation (BLC) enhances objects in the center of the picture. The device uses the center of the picture to adjust the iris. If there is a bright light source outside of this area, it will wash out to white. The camera will adjust the iris so that the object in the sensitive area is properly exposed.

There are two backlight compensation settings:

OFF (default): Backlight compensation is not activated.

ON: Backlight compensation is activated.

If backlight compensation is ON, decrease the auto iris level setting and adjust the auto IR level to a darker setting. Refer to *Auto Iris* on page 29 and *Auto IR Level* section on page 28.

ELECTRONIC IMAGE STABILIZATION

Electronic image stabilization is a feature of the camera that can compensate for some forms of external influences. In all cases, care should be taken to make sure that any device is mounted to a rigid location.

In the event that vibration is introduced to the device, a user can select one of the electronic image stabilization settings in the menu. The available settings are OFF, 5 Hz, and 10 Hz. Users should apply each of the settings to the camera to see which one best addresses the vibration that is affecting the video quality.

Electronic image stabilization will not correct for all ranges of vibration. If either of the settings fails to eliminate the vibration seen in the video, other measures should be taken to isolate the vibration or to seek a more rigid mounting location.

NOTES:

- When electronic image stabilization is applied, digital slow shutter and wide dynamic range are disabled. Zoom, image resolution, and viewing angle are also limited when this feature is activated.
- Electronic image stabilization cannot be used while in a preset that has motion detection activated.

WIDE DYNAMIC RANGE

Wide dynamic range (WDR) balances the brightest and darkest sections of a scene to produce a picture that is better balanced in lighting and provides more detail.

Available settings are OFF and ON; the default setting is OFF. When wide dynamic range is set to ON, the frame rate is reduced from the standard 30 to 15 frames per second (fps). Also, when this setting is ON, the iris will not close completely, even in manual mode.

NOTE: Wide dynamic range is disabled when electronic image stabilization is set to 5 Hz or 10 Hz.

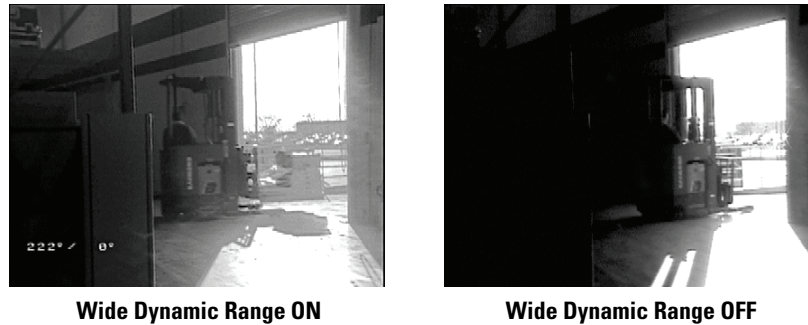

Figure 10. Wide Dynamic Range Settings

LOW LUX NOISE REDUCTION

Low lux noise reduction helps to reduce video noise in low light scenes. When enabled, low lux noise reduction is directly affected by the AGC settings for the device.

The following are the low lux noise reduction settings:

ON (default): Low lux noise reduction is enabled. As the scene darkens and AGC increases, the noise reduction effect automatically increases. As noise reduction increases, you may also notice some afterimaging and a slight reduction in color saturation.

OFF: Low lux noise reduction is disabled.

VIDEO LEVEL

Set the video output to one of the following options:

NORMAL: 1.0 Vp-p.

HIGH (default setting): 1.2 Vp-p to compensate for losses in video cable.

FIELD ALIGN

Field align determines whether the camera produces progressive segmented frame output (PsF) or interlaced frame output. Analog video from the camera is always output in separate fields as required for compatibility. This feature allows PsF to be recombined by an encoding device without a time difference between fields, as is typically seen from interlaced analog video output. Enabling field align requires that the encoding device you are using always combines the odd and even fields in the specified order.

There are three field alignment settings:

OFF (default): Field alignment is disabled. Use this setting if you are using an analog device/system or a digital encoder that does not support PsF.

ODD: Arranges the odd field for a particular video frame before the even field for that frame.

EVEN: Arranges the even field for a particular video frame before the odd field for that frame.

NOTES:

- If you enable field alignment by selecting ODD or EVEN, you must disable any deinterlacing settings for the encoding device to achieve maximum resolution.
- The ODD and EVEN settings require that the sensor scan mode is set to PROGRESSIVE. If field align is set to ODD or EVEN, the sensor scan mode automatically changes to PROGRESSIVE.

LOW LIGHT SHARPNESS

Low light sharpness allows you to control the video sharpness in low-light scenes. The available settings are 20, 10, DEFAULT, -10, and -20. Increasing the value increases sharpness in low-light scenes, but also increases video noise. Decreasing the value decreases video noise in low-light scenes, but it also decreases image sharpness.

NOTE: Changing the low light sharpness causes the camera to reset, which resets all camera settings to their factory defaults.

MINIMUM FOCUS DISTANCE

Minimum focus distance improves focus capability in low-light scenes, depending on the typical distance between the camera and objects in the scene. There are two settings:

30 CM (default): Improves focus for scenes in which the camera is typically focusing on objects at close range (less than 3 meters).

3 M: Improves focus for scenes in which the camera is typically focusing on objects at a distance of 3 meters or more.

ZOOM FOCUS TRACE

Zoom focus trace adjusts the camera's focus so it follows the predefined focus values that are associated with respective zoom values. This keeps the scene in focus during quick zoom in and zoom out operations.

NOTE: You might see a short delay when you initiate a zoom operation if zoom focus trace and auto focus are enabled.

There are three settings:

NIGHT (default): Applies zoom focus trace in dark scenes.

DAY/NIGHT: Applies zoom focus trace in both light and dark scenes.

OFF: Disables the zoom focus trace.

MOTION SETTINGS

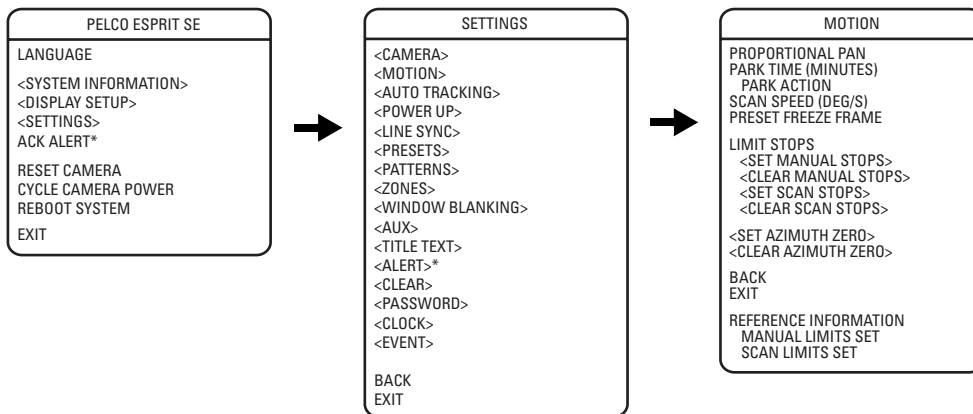

PROPORTIONAL PAN

Proportional pan automatically reduces or increases the pan and tilt speeds in proportion to the amount of zoom. At telephoto zoom settings, the pan and tilt speeds will be slower for a given amount of joystick deflection than at wide zoom settings. This keeps the image from moving too fast on the monitor when there is a large amount of zoom.

There are three proportional pan modes:

ON (default): Enables the proportional pan mode.

OFF: Disables proportional pan mode. The pan speed will not depend on the amount of zoom.

2X: Increases the speed of the proportional pan mode to twice that used when proportional pan is set to ON.

PARK TIME

This feature allows the device to begin a specified operation (scan, preset, or pattern) after a configured period of inactivity.

Park time can be configured from 1 to 720 minutes (12 hours), or set to zero, which disables this feature. The default setting is zero.

Park Action

This feature will define the activity when the device parks. The following settings are available:

NONE (default): No action.

AUTO SCAN: Device starts auto scan operation.

*This setting applies to pressurized devices only.

FRAME SCAN: Device starts frame scan operation.

RANDOM SCAN: Device starts random scan operation.

PATTERN 1: Device runs pattern 1.

PATTERN 2: Device runs pattern 2.

PATTERN 3: Device runs pattern 3.

PATTERN 4: Device runs pattern 4.

PATTERN 5: Device runs pattern 5.

PATTERN 6: Device runs pattern 6.

PATTERN 7: Device runs pattern 7.

PATTERN 8: Device runs pattern 8.

PRESET 1: Device goes to preset 1.

PRESET 8: Device goes to preset 8.

SCAN SPEED

Scan speed is the degrees per second that the device will pan when in a scan mode. Scan speed is adjustable from 1 to 40 degrees per second through the camera menu. The default setting is 25 degrees per second.

PRESET FREEZE FRAME

This feature freezes the scene on the monitor when going to a preset. This allows for smooth transition from one preset scene to another. Preset freeze frame also reduces bandwidth when used with digital network systems such as PelcoNet™ and guarantees that blanked areas will not be revealed when going to a preset.

There are three preset freeze frame settings:

ON: The image on the screen freezes when a preset is called. When the device reaches the preset, the image is unfrozen and the preset scene is displayed.

OFF: The image is never frozen.

AUTO (default): Freeze frame is turned on automatically if window blanking is ON. If window blanking is OFF, freeze frame is off.

LIMIT STOPS

Limit stops are configurable stops that limit the pan range of the device. There must be two limits, a left and a right, to define an area.

There are two types of limit stops:

MANUAL: A manual (joystick) pan operation stops when a limit stop is reached.

SCAN: The device reverses direction during random, frame, or auto scanning when a limit stop is reached.

To set manual or scan stops:

1. Use the joystick to position the cursor beside SET MANUAL STOPS or SET SCAN STOPS.
2. Press Iris Open.
3. Follow the directions displayed on the monitor.

NOTE: For the manual or scan stops to work, the LIMIT STOPS option must be ON.

To clear manual or scan stops:

1. Use the joystick to position the cursor beside CLEAR MANUAL STOPS or CLEAR SCAN STOPS.
2. Press Iris Open.
3. Follow the directions displayed on the monitor.

AZIMUTH ZERO

Azimuth is the pan angle from zero to 359 degrees. Azimuth zero is the pan position you specify to be the zero degree point. Azimuth zero is normally set to magnetic north. Once set, azimuth and compass readings are based on the set Azimuth Zero point.

To configure azimuth zero:

1. Use the joystick to position the cursor beside SET AZIMUTH ZERO.
2. Press Iris Open.
3. Follow the directions displayed on the monitor.

To clear azimuth zero:

1. Use the joystick to position the cursor beside CLEAR AZIMUTH ZERO.
2. Press Iris Open.
3. Follow the directions displayed on the monitor.

AUTO TRACKING

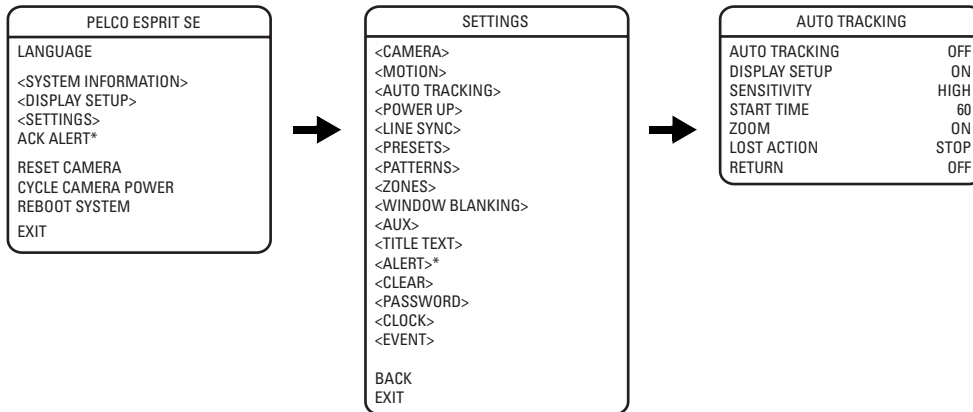

AUTO TRACKING

Auto tracking allows the camera to automatically pan, tilt, and zoom to track objects of interest (people, cars, and so forth) when motion is detected in a scene without requiring an operator to manually control the camera's PTZ movements. There are two settings:

ON: Auto tracking is enabled.

OFF (default): Auto tracking is disabled.

NOTE: If the auto tracking setting is OFF, all other settings in the Auto Tracking menu are disabled.

DISPLAY SETUP

When display setup is enabled, you are notified that the camera detects motion in a scene. There are two settings:

ON (default): Display setup is enabled and a transparent blue rectangle appears in the area of the scene where motion has been detected.

OFF: Display setup is disabled.

*This setting applies to pressurized devices only.

SENSITIVITY

Sensitivity adjusts the camera's sensitivity to motion, thereby adjusting the number of moving objects that will be tracked automatically. There are two settings:

HIGH (default): Sensitivity is increased and most moving objects, regardless of size, will be detected and tracked.

LOW: Sensitivity is decreased and smaller movements that may not be as significant will not be tracked.

START TIME

Start time is the amount of time between the execution of a user command and the start of auto tracking. The start time can be set between 1 and 10 minutes. The default setting is 1 minute.

ZOOM

When zoom is enabled, the camera automatically zooms in or out to keep the object of interest in the main field of view. There are two settings:

ON (default): Automatic zoom is enabled.

OFF: Automatic zoom is disabled.

LOST ACTION

If the object of interest is lost from the field of view and there is no other moving object to track, the camera will either stop automatic PTZ or will zoom out to attempt to relocate a moving object. There are two settings:

STOP (default): Automatic PTZ stops if the object of interest is lost from the field of view.

ZOOM OUT: The camera zooms out to attempt to relocate the object of interest or to locate a new moving object to auto track.

RETURN

Return is the amount of time after the last motion has been detected and the time at which the camera returns to the location where auto tracking began. Return can be set between 10 and 60 seconds or it can be turned off. The default setting is OFF.

POWER UP

POWER UP ACTION

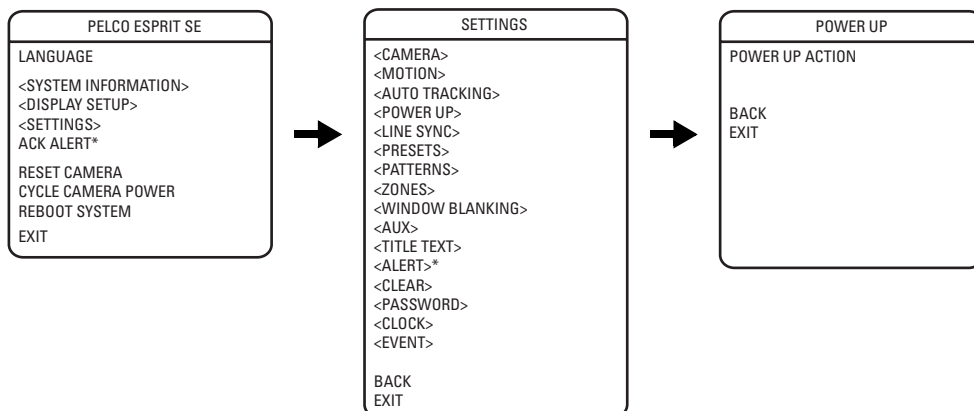

This setting defines a specific activity (scan, preset, pattern) to be performed in the event the power to the device is cycled.

The following settings are available:

NONE: No action.

AUTO (default): The device resumes its prior activity or direction before the power outage occurred.

*This setting applies to pressurized devices only.

- PRESET 1:** Device goes to preset 1.
- PRESET 2:** Device goes to preset 2.
- PRESET 3:** Device goes to preset 3.
- PRESET 4:** Device goes to preset 4.
- PRESET 5:** Device goes to preset 5.
- PRESET 6:** Device goes to preset 6.
- PRESET 7:** Device goes to preset 7.
- PRESET 8:** Device goes to preset 8.
- AUTO SCAN:** Device starts auto scan operation.
- FRAME SCAN:** Device starts frame scan operation.
- RANDOM SCAN:** Device starts random scan operation.
- PATTERN 1:** Device runs pattern 1.
- PATTERN 2:** Device runs pattern 2.
- PATTERN 3:** Device runs pattern 3.
- PATTERN 4:** Device runs pattern 4.
- PATTERN 5:** Device runs pattern 5.
- PATTERN 6:** Device runs pattern 6.
- PATTERN 7:** Device runs pattern 7.
- PATTERN 8:** Device runs pattern 8.

LINE SYNC

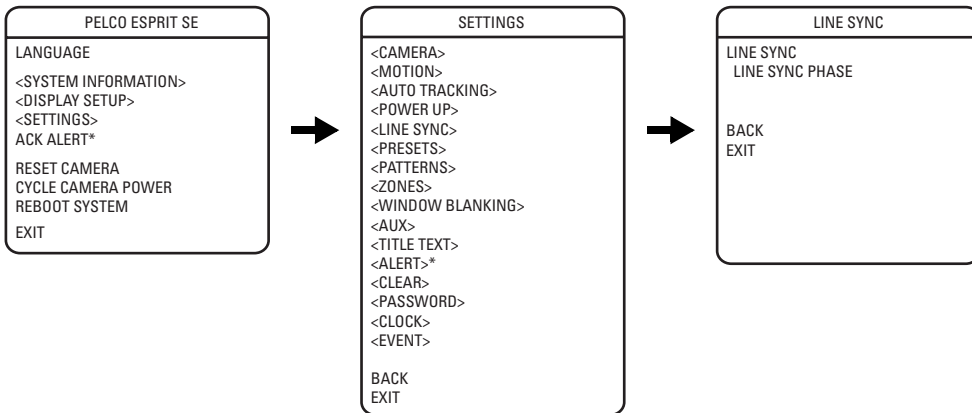

Line sync refers to a configurable function that allows you to synchronize all cameras within a matrix system.

The device automatically senses V-Sync input. No line sync setup is required for Pelco control systems that provide a V-Sync signal.

For matrix systems that do not output V-Sync, there are two settings for line synchronization:

ON: Adjusts the phase of the line sync to synchronize input power. Line sync phase settings range from zero to 359 degrees.

OFF (default): The device synchronizes to the internal clock.

PRESETS

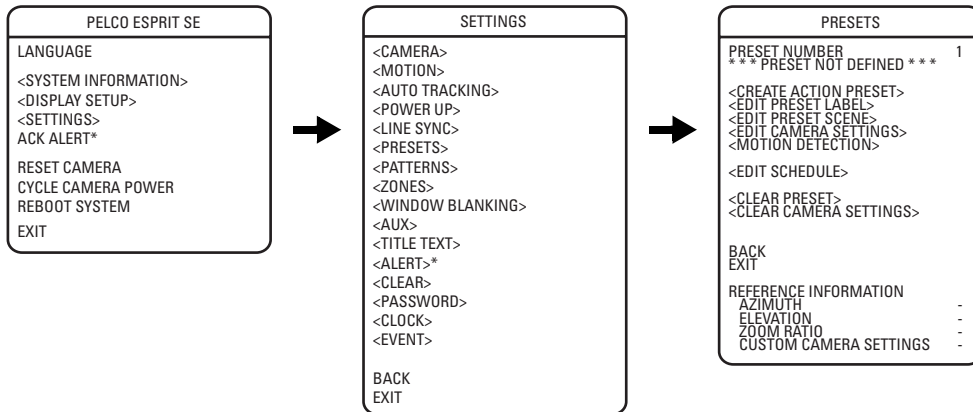

There are 256 preset positions. The presets that can be configured are numbered 1 to 32, 35 to 82, and 100 to 256.

NOTE: The number of available presets may be limited by the head-ins, controllers, and DVRs that are connected to your device.

Each of the user-definable presets can be configured to use pan, tilt, camera settings, and motion detection.

PREDEFINED PRESETS

The following presets are predefined for specific functions:

Preset 34: Pan zero command; directs the device to the factory-determined zero reference point

Preset 83 to 87: Reserved

Preset 88: IR filter IN (color)

Preset 89: IR filter OUT (black-white)

Preset 90 to 91: Manual limit stops

Preset 92 to 93: Scan limit stops

Preset 94: Reserved

Preset 95: Select main configuration menu

Preset 96: Stop a scan

Preset 97: Random scanning

Preset 98: Frame scanning

Preset 99: Start auto scanning

*This setting applies to pressurized devices only.

NOTE: For American Dynamics™ controllers with only 32 presets, switch SW2-1 on the device to the ON position. When SW2-1 is ON, several presets change (refer to Table B).

Table B. Presets for American Dynamics Controllers

Esprit SE Presets	American Dynamics Controller Presets
88	21
89	22
90	23
91	24
92	25
93	26
95	28
96	29
97	30
98	31
99	32

If the limit stops are turned off, presets 23 to 26 can be used as regular presets.

CONFIGURING A PRESET

1. Select the preset number:
 - a. Use the joystick to position the cursor beside PRESET NUMBER. Press Iris Open. The cursor moves to the right.
 - b. Move the joystick up or down to view the selections. Press Iris Open to enter the selection.
2. Edit the preset label:
 - a. Use the joystick to position the cursor beside EDIT PRESET LABEL.
 - b. Press Iris Open. The following information appears:

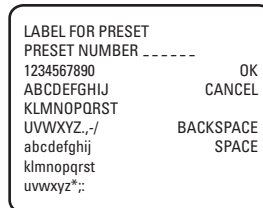

- c. Use the joystick to position the cursor beside a character. Press Iris Open to enter the selection. To clear a character, position the cursor beside BACKSPACE, and then press Iris Open.
 - d. When label is completed, move the cursor to OK. Press Iris Open to return to the Preset menu.
3. Edit the preset scene:
 - a. Use the joystick to position the cursor beside EDIT PRESET SCENE.
 - b. Press Iris Open.
 - c. Follow the directions displayed on the monitor.
4. Edit preset camera settings:
 - a. Use the joystick to position the cursor beside EDIT CAMERA SETTINGS.
 - b. Press Iris Open. The EDIT CAMERA SETTINGS window appears. Refer to *Camera* on page 26 and *Advanced Camera Settings* on page 29 to change preset camera settings.
 - c. To edit the camera settings schedule, use the joystick to position the cursor beside EDIT SCHEDULE. Press Iris Open.

The Edit Schedule menu is a duplicate of the Edit Event menu (refer to *Event* on page 54) with the following exceptions. In the Edit Schedule menu, the event type cannot be changed. Also, the Holiday feature cannot be accessed from the Edit Schedule menu.

For instructions on changing the features in the Edit Schedule menu, refer to *Edit Event* on page 55.

NOTES:

- There are two additional options available for the IR cut filter that are only available when configuring a preset. The additional settings are IN and OUT. If the IR cut filter is set to IN, the preset scene will be in color. If the IR cut filter is set to OUT, the preset scene will be in black-white.
- You can copy camera settings from one preset to another preset. To copy camera settings do the following:
 - (1) Use the joystick to position the cursor beside COPY CAMERA SETTINGS.
 - (2) Press Iris Open. The cursor moves to the right.
 - (3) Move the joystick up or down to view the selections. Press Iris Open to enter the selection.
- The “Apply to Global” setting allows camera settings specified for a particular preset to remain in effect even after the preset has been completed.

CREATING AN ACTION PRESET

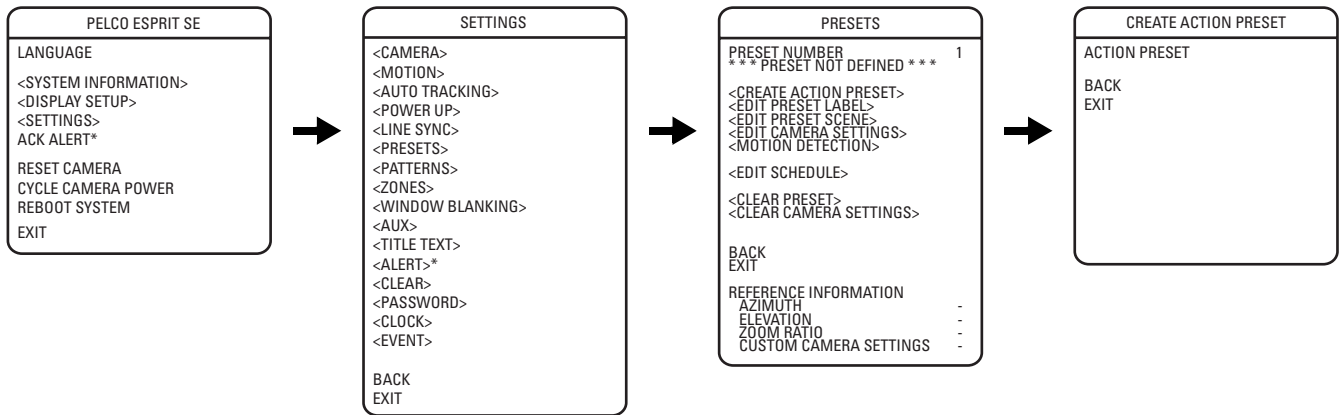

An action preset is a user-defined preset that, instead of moving the unit to a predefined location, performs a predefined action.

To create an action preset:

1. Select the preset number:
 - a. Use the joystick to position the cursor beside PRESET NUMBER. Press Iris Open. The cursor moves to the right.
 - b. Move the joystick up or down to view the selections. Press Iris Open to enter the selection.
2. Create the action preset:
 - a. Use the joystick to position the cursor beside CREATE ACTION PRESET. Press Iris Open. The Create Action Preset menu opens.
 - b. Use the joystick to position the cursor beside ACTION PRESET. Press Iris Open. The cursor moves to the right.
 - c. Move the joystick up or down to view the selections. Press Iris Open to enter one of the following selections:

NORMAL: Numerical preset assigned to a fixed location. Standard functionality of presets.

WIDE DYNAMIC RAN: Wide dynamic range is turned on or off when the preset is triggered.

E. IMAGE STABILI: Electronic image stabilization is turned on or off when the preset is triggered.

BACKLIGHT COMP: Back light compensation is turned on or off when the preset is triggered.

ACTIVATE AUX: AUX 1 is activated when the preset is triggered.

AUTO TRACKING: Auto tracking is turned on or off when the preset is triggered.

3. Use the joystick to position the cursor beside BACK or EXIT and press Iris Open to leave the Create Action Preset menu.

NOTES:

- When you create an action preset, the standard preset functions (edit preset label, edit preset scene, edit camera settings, and motion detection) are not available.
- Action presets cannot be part of a pattern.

*This setting applies to pressurized devices only.

MOTION DETECTION

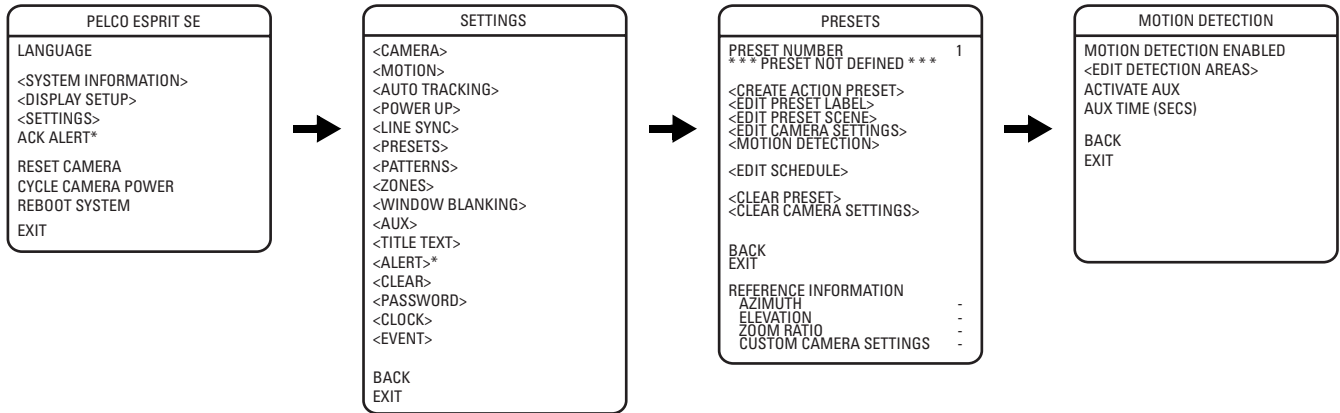

Enable Motion Detection

The following are the settings for motion detection:

OFF (default): Motion detection is turned off (disabled).

ON: Motion detection is turned on (enabled).

NOTE: Motion detection does not work if the shutter speed is set at less than 1/60 of a second.

Edit Detection Areas

Four motion detection areas can be defined for a preset. Use the following steps to edit motion detection areas.

1. Edit detection areas 1, 2, 3, or 4:
 - a. Use the joystick to position the cursor beside EDIT DETECTION AREAS.
 - b. Press Iris Open. The EDIT DETECTION AREAS configuration window appears.

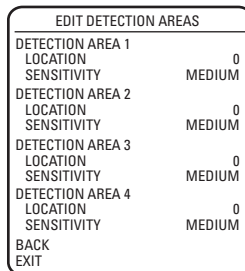

- c. Use the joystick to position the cursor beside LOCATION for DETECTION AREA 1, 2, 3, or 4.
- d. Press Iris Open. The cursor moves to the right next to the number 0.
- e. Move the joystick up. A blue rectangle appears in the upper-left corner of the screen (refer to Figure 11 on page 41).
- f. Use the joystick to place the blue rectangle over the desired detection area.
- g. Press Iris Open to enter the selection.



Figure 11. Motion Detection Areas

2. Set the sensitivity of the motion detection area:
 - a. Position the cursor next to SENSITIVITY for DETECTION AREA 1, 2, 3, or 4.
 - b. Press Iris Open, the cursor moves to the right.
 - c. Use the joystick to select one of the following sensitivity levels:
 - HIGH:** The sensitivity level is high.
 - MEDIUM (default):** Average sensitivity.
 - LOW:** The sensitivity level is low.
 - d. Press Iris Open to enter the selection.

NOTE: Motion detection is not guaranteed to catch 100 percent of activity.

Activate Aux Command

Motion detection can be configured to trigger an auxiliary command when motion is detected. The following are the settings for ACTIVATE AUX:

OFF (default): Motion detection will not trigger an AUX command.

1: Triggers a command to AUX 1.

2: Triggers a command to AUX 2.

Aux Time

Aux time is the length of time the auxiliary will remain on after motion is detected. Available settings for AUX TIME are 1 to 60 seconds.

EDIT SCHEDULE

The Edit Schedule menu is a duplicate of the Edit Event menu (refer to *Event* on page 54) with the following exceptions. In the Edit Schedule menu, the event type cannot be changed. Also, the Holiday feature cannot be accessed from the Edit Schedule menu.

For instructions on changing the features in the Edit Schedule menu, refer to *Edit Event* on page 55.

PATTERNS

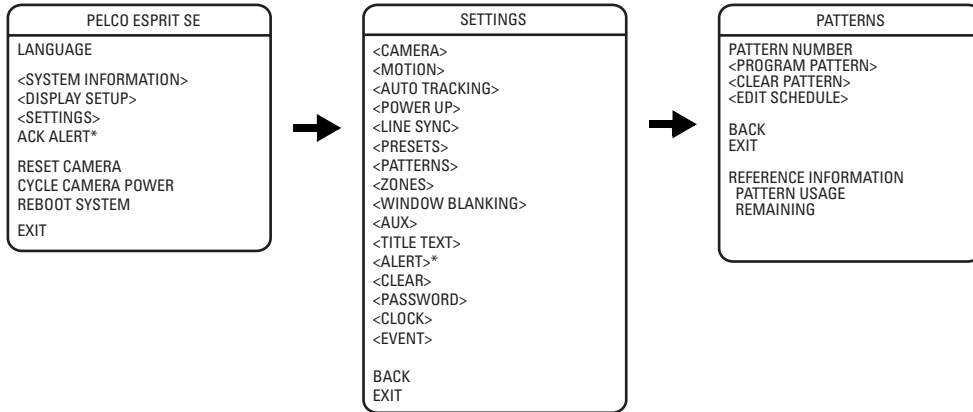

A pattern is a memorized, repeating series of pan, tilt, zoom, and preset functions that can be recalled with a command from a controller or automatically by a configured function (alarm, park, event, or power-up).

The device can accommodate up to eight patterns. Pattern length is based upon memory usage rather than a fixed amount of time. The complexity of a pattern will determine the amount of storage available to configure other patterns.

NOTE: In most cases, the memory available will allow for ample time to schedule typical patterns. If the scheduled patterns are unusually lengthy or complex, there is a possibility that there may not be enough remaining memory to configure all eight patterns.

To configure a pattern:

1. Use the joystick to position the cursor beside PATTERN NUMBER. Press Iris Open. The cursor moves to the right.
2. Move the joystick up or down to view the selections. Press Iris Open to enter the selection.
3. Use the joystick to position the cursor beside PROGRAM PATTERN.
4. Press Iris Open. The Patterns configuration window appears.
5. Follow the directions displayed on the monitor.

After a pattern is configured, the remaining storage percentage is displayed on the screen. This is the amount of memory available to configure the remaining patterns.

To clear a pattern:

1. Use the joystick to position the cursor beside CLEAR PATTERN.
2. Press Iris Open.
3. Follow the directions displayed on the monitor.

To edit the pattern schedule:

The Edit Schedule menu is a duplicate of the Edit Event menu (refer to *Event* on page 54) with the following exceptions. In the Edit Schedule menu, the event type cannot be changed. Also, the Holiday feature cannot be accessed from the Edit Schedule menu.

For instructions on changing the features in the Edit Schedule menu, refer to *Edit Event* on page 55.

NOTE: When configuring one or more presets within a pattern, use the normal controller commands to call a preset. Not all controllers can start all patterns. However, any of the patterns can be automatically started with park, power-up, event, and alarm functions.

*This setting applies to pressurized devices only.

ZONES

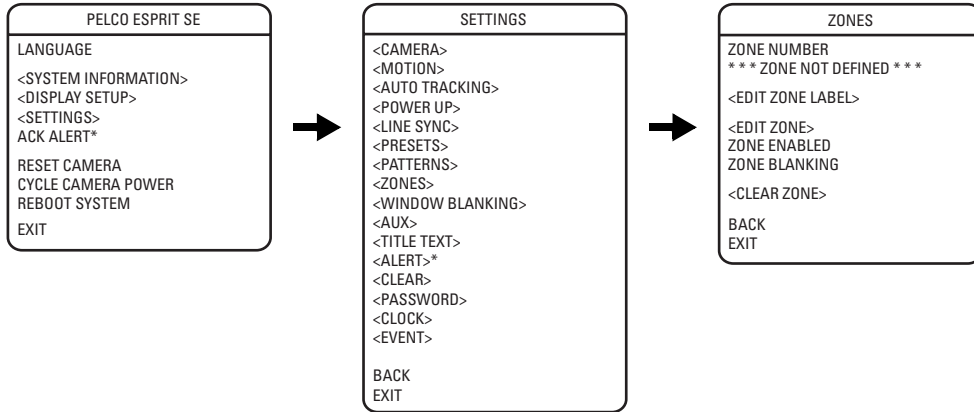

A zone is a pan area, defined by a left and right limit, on the 360-degree pan plane. The device is capable of eight zones, each with a 20-character label.

To configure a zone:

1. Use the joystick to position the cursor beside ZONE NUMBER. Press Iris Open, and the cursor moves to the right.
2. Move the joystick up or down to view the selections. Press Iris Open to enter the selection.
3. Use the joystick to position the cursor beside EDIT ZONE.
4. Press Iris Open. The Zone configuration window appears.
5. Follow the directions displayed on the monitor. After the left and right limit stops are set, the Zones menu reappears with the ZONE ENABLED option set to YES.

To edit a zone label:

1. Use the joystick to position the cursor beside EDIT ZONE LABEL.
2. Press Iris Open. The following information appears:

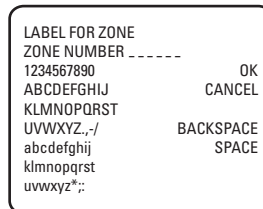

3. Use the joystick to position the cursor beside a character. Press Iris Open to enter the selection. To clear a character, position the cursor beside BACKSPACE, and then press Iris Open.
4. When the label is completed, move the cursor to OK. Press Iris Open to return to the Zones menu.

To disable a zone (a zone is enabled automatically when it is configured) or to blank a zone:

1. Move the cursor beside ZONE ENABLED or ZONE BLANKING.
2. Press Iris Open. The cursor moves to the right.
3. Move the joystick up or down to view the selections. Press Iris Open to enter the selection.

To clear a zone:

1. Use the joystick to position the cursor beside CLEAR ZONE.
2. Press Iris Open. Follow the instructions on the screen.

*This setting applies to pressurized devices only.

WINDOW BLANKING

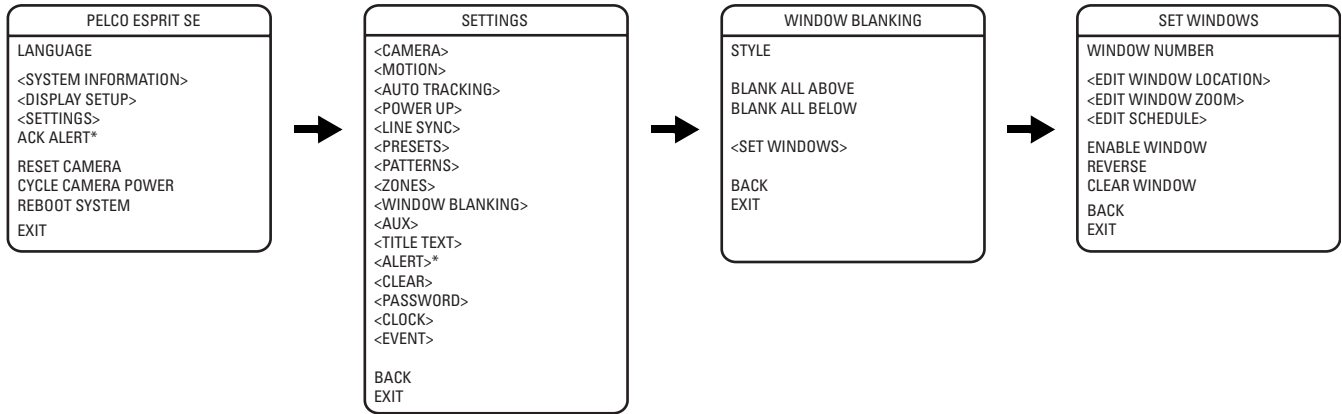

Window blanking allows a user to configure the four-sided areas that cannot be viewed by the operator of the device. A blanked area will move with pan and tilt functions and automatically adjust in size as the lens zooms telephoto and wide.

There are eight available user-defined window blanks.

The device has two styles of window blanking: Gray and Smear. If the style is set to Gray, the blanked area is covered with a solid gray window. If Smear is selected images behind the window will be noticeable but not distinguishable.

To set a window blanking area:

1. Use the joystick to position the cursor beside WINDOW BLANKING. Press Iris Open. The WINDOW BLANKING menu appears on the screen.
2. Move the joystick to position the cursor beside SET WINDOWS. Press Iris Open to enter.
3. Position the cursor beside WINDOW NUMBER. Press Iris Open. The cursor moves to the right.
4. Move the joystick up or down to view the selections. Press Iris Open to enter the selection.
5. Use the joystick to position the cursor beside EDIT WINDOW LOCATION. Press Iris Open, and then follow the instructions that appear on the screen. When all four corners are set, the SET WINDOWS menu reappears, the blanked area is displayed, and the ENABLE WINDOW option is set to YES.

NOTES:

- Use the outside corner of the window selection tool as a guide when selecting the upper left, upper right, bottom right, and bottom left corners of the window.

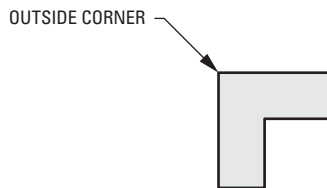

Figure 12. Window Selection Tool

*This setting applies to pressurized devices only.

- Set windows are not visible when editing a new window location.



Figure 13. Window Blanking

6. The blanked area can be configured to turn on or off at a specified zoom point. To set the zoom point:
 - a. Use the joystick to position the cursor beside EDIT WINDOW ZOOM, and then press Iris Open.
 - b. Zoom in to the point where you want window blanking to turn on. Press Iris Open to set the zoom point.

NOTES:

- Since the area is already blanked out, it may be difficult to determine when you want window blanking to turn on. Reverse the window before setting the zoom point. When finished reverse the window again to blank out the area.
- Increase the size of the window if any part of the blanked area is revealed during PTZ operations.

EDIT SCHEDULE

The Edit Schedule menu is a duplicate of the Edit Event menu (refer to *Event* on page 54) with the following exceptions. In the Edit Schedule menu, the event type cannot be changed. Also, the Holiday feature cannot be accessed from the Edit Schedule menu.

For instructions on changing the features in the Edit Schedule menu, refer to *Edit Event* on page 55.

REVERSE

A blanked out area can be reversed to make it visible and the areas on both sides of it not visible. The areas above and below the blanking area remain visible. Reversing the window a second time will return it to its original condition.

CLEAR WINDOW

All areas that have been set for window blanking are cleared.

BLANK ALL ABOVE/BLANK ALL BELOW

The Blank All Above and Blank All Below options add additional flexibility to setting up privacy areas. These settings are ideal for applications where a complete pan location needs to be blanked.

Table C. Window Blank Settings

Blank All Above		Blank All Below	
Tilt Angle	Blanked Area	Tilt Angle	Blanked Area
OFF	No blanking	OFF	No blanking
50	50° to 62° above horizon	50	50° above horizon to 112° below horizon
40	40° to 62° above horizon	40	40° above horizon to 112° below horizon
30	30° to 62° above horizon	30	30° above horizon to 112° below horizon
20	20° to 62° above horizon	20	20° above horizon to 112° below horizon
10	10° to 62° above horizon	10	10° above horizon to 112° below horizon
0	Horizon to 62° above horizon	0	Horizon to 112° below horizon
-10	10° below horizon to 62° above horizon	-10	10° to 112° below horizon
-20	20° below horizon to 62° above horizon	-20	20° to 112° below horizon
-30	30° below horizon to 62° above horizon	-30	30° to 112° below horizon
-40	40° below horizon to 62° above horizon	-40	40° to 112° below horizon
-50	50° below horizon to 62° above horizon	-50	50° to 112° below horizon
-60	60° below horizon to 62° above horizon	-60 <td 60° to 112° below horizon	
-70	70° below horizon to 62° above horizon	-70	70° to 112° below horizon
-80	80° below horizon to 62° above horizon	-80	80° to 112° below horizon

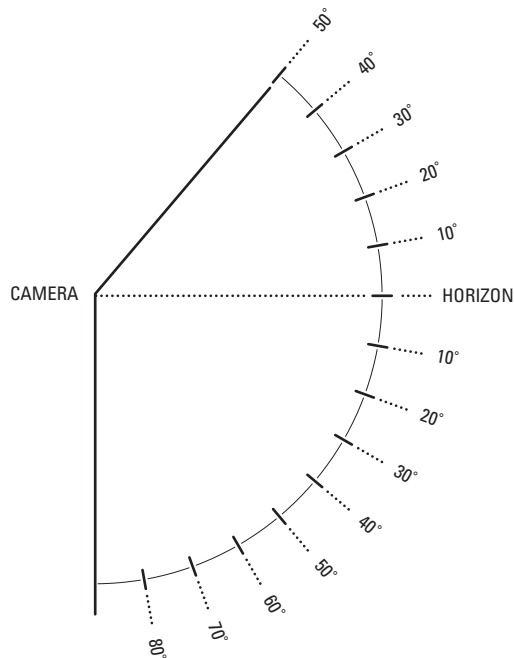
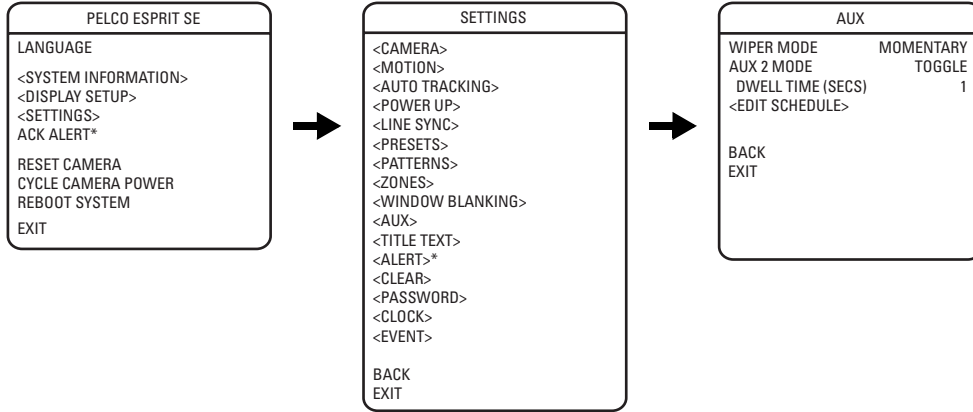

Figure 14. Window Blank Tilt Angles

AUX



An auxiliary output is a configurable signal from the Esprit SE that can trigger another device to operate. An auxiliary output can be configured to trigger from an alarm or from a controller.

An AUX 1 command from the controller will activate the relay in the Esprit SE and operate the device that is connected to the relay. The output of AUX 1 can be connected to the alarm input of a system switch to activate automatic monitor switching and recording.

An AUX 2 command from the controller will place a ground at the output of AUX 2 to operate the device that is connected to it.

The following are the available AUX mode settings:

TOGGLE (default): Changes the state of the auxiliary output every time an AUX command is received from the controller.

LATCHING: Must receive an AUX ON/AUX OFF command from the controller to turn the auxiliary output on/off.

MOMENTARY: An AUX ON command from the controller turns the auxiliary output on for the configured DWELL TIME. The auxiliary output will automatically turn off when the dwell time is finished.

WIPER

The available settings for wiper mode are Wiper Mode, Wiper Dwell, and Wiper Time.

To change the wiper settings:

1. Configure preset 95 (28). The main menu appears.
 2. Position the cursor (>) beside Wiper.
 3. Press the Iris Open button to enter the Wiper menu.
 4. Move the joystick up or down to position the cursor next to one of the wiper settings.
 5. Press the Iris Open button. The cursor moves to the right.
 6. Move the joystick up or down to toggle through the choices.
 - **Momentary Mode:** To operate the wiper one full cycle, press the AUX 1 button on your controller. Each press of the button operates the wiper one full cycle, even if the AUX 1 button is latching. If AUX 1 is latching, the first press will activate the wiper (open the latch). Pressing AUX 1 a second time closes the latch, but will not cycle the wiper. Press the AUX 1 key again to cycle the wiper.
 - **Continuous Mode:** To operate the wiper press the AUX 1 button on your controller. The wiper will continue to operate until the AUX 1 button is pressed again or until the configured cycle is completed.
- CM9740 and CM9760 matrix systems only:* For the wiper to operate in continuous mode, the AUX 1 function in the camera file must be set to latching. If the AUX 1 camera file is not latching, the wiper will only operate in momentary mode, even if the Esprit wiper is configured for continuous operation. Refer to the operation manual supplied with the CM9740 or CM9760 matrix system for instructions.
- **Wiper Dwell:** The time between wiper cycles. The dwell time can be configured from 2 to 255 seconds.
 - **Wiper Time:** The length of the wiper cycle. Wiper time can be configured from 2 to 1,440 minutes (2 minutes to 24 hours).

*This setting applies to pressurized devices only.

7. Press one of the following buttons on your keyboard:
 - **Iris Open:** Press the Iris Open button to select your choice.
 - **Iris Close:** Press the Iris Close button if you do not want to change the setting.

EDIT SCHEDULE

The Edit Schedule menu is a duplicate of the Edit Event menu (refer to *Event* on page 54) with the following exceptions. In the Edit Schedule menu, the event type cannot be changed. Also, the Holiday feature cannot be accessed from the Edit Schedule menu.

For instructions on changing the features in the Edit Schedule menu, refer to *Edit Event* on page 55.

TITLE TEXT

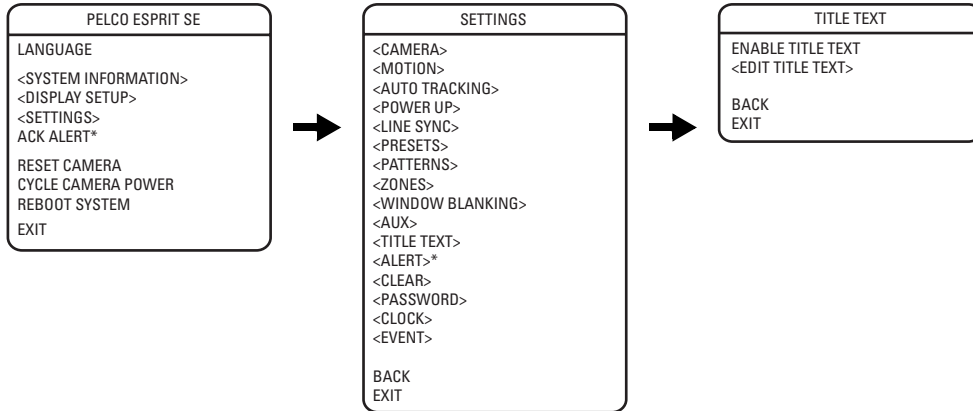

Title text is the label used to identify the camera viewed on the monitor. Up to 20 characters can be used for a title.

To edit the title text label, do the following:

1. Use the joystick to position the cursor beside EDIT TITLE TEXT.
2. Press Iris Open. The following information appears:

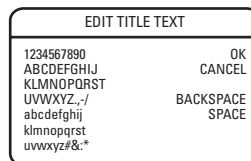

3. Use the joystick to position the cursor beside a character. Press Iris Open to select the character. To clear a character, position the cursor beside BACKSPACE, and then press Iris Open.
4. When the title is completed, move the cursor to OK. Press Iris Open to return to the Title Text menu.
5. Enable the title text label by doing the following:
 - a. Move the cursor beside ENABLE TITLE TEXT.
 - b. Press Iris Open. The cursor moves to the right.
 - c. Move the joystick up or down to view the selections. Select ON and then press Iris Open to enable the title text.

*This setting applies to pressurized devices only.

ALERT

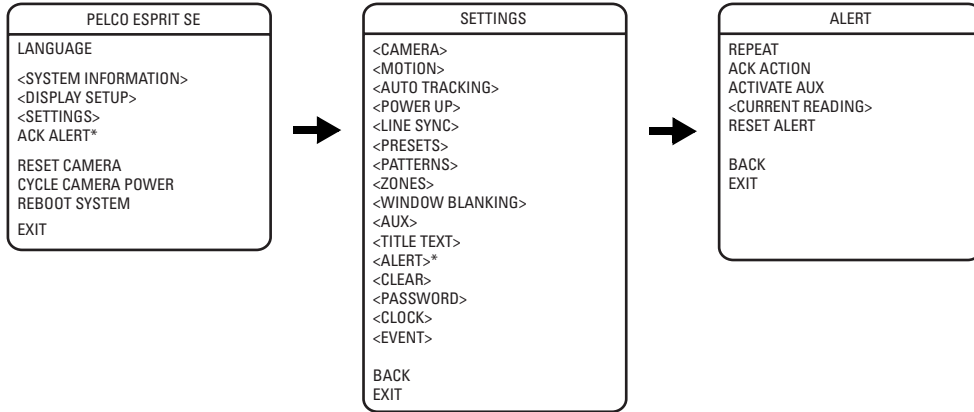

NOTE: The Alert option applies to pressurized devices only. Devices that are not pressurized will not display this menu item.

Sensors strategically placed inside the pressurized device continually monitor pressure, temperature, and dew point. If internal conditions reach unacceptable levels, an alert message appears on the screen describing the alert condition. For example, if pressure drops below 1 psig, LOW PRESSURE is displayed.

The following system conditions will trigger an alert message:

System Condition	Alert Message
Temperature is above 60°C (140°F)	HIGH TEMPERATURE
Temperature is below -40°C (-40°F)	LOW TEMPERATURE
Pressure is above 13 psig	HIGH PRESSURE
Pressure is below 1 psig	LOW PRESSURE
The difference between the temperature and the dew point is less than or equal to 3°C.	DEW POINT (HIGH HUMIDITY)

The alert message will be repeatedly displayed until the system controller acknowledges the alert condition by selecting ACK ALERT in the main menu. Once acknowledged, the alert message changes to the configured acknowledge action (ACK ACTION). If the alert condition remains active after a period of time, the alert message reappears on the monitor, restarting the alert message cycle. This cycle will continue to repeat until the alert condition is resolved.

REPEAT

This setting configures the frequency an alert message is repeatedly displayed until the system controller acknowledges the alert condition. The following are the settings:

- CONSTANT:** The alert message is continuously displayed until acknowledged.
- 15 MIN:** The alert message is displayed every 15 minutes for a 15-second duration until acknowledged.
- 30 MIN:** The alert message is displayed every 30 minutes for a 15-second duration until acknowledged.
- 60 MIN:** The alert message is displayed every 60 minutes for a 15-second duration until acknowledged.
- OFF:** The alert message is disabled and will not be displayed.

ACK ACTION

Set ACK ACTION to configure the frequency at which an alert message is displayed after the alert condition has been acknowledged. The following settings are available:

- ALWAYS ON:** The alert message is displayed until alert conditions are cleared.
- OFF 8 HRS:** The alert message is turned off for 8 hours. Message returns after 8 hours if the alert condition persists.
- OFF 24 HRS:** The alert message is turned off for 24 hours. Message returns after 24 hours if the alert condition persists.
- OFF 48 HRS:** The alert message is turned off for 48 hours. Message returns after 48 hours if the alert condition persists.

*This setting applies to pressurized devices only.

ACTIVATE AUX

This setting activates an auxiliary when an alert condition exists. Settings include the following options:

NONE (default): Not activated.

1: An alert condition will close AUX 1.

2: An alert condition will close AUX 2.

CURRENT READING

The Current Reading menu displays the existing status of temperature, pressure, and dew point inside the device. An arrow displayed to the left of a menu item denotes that an alert condition exists.

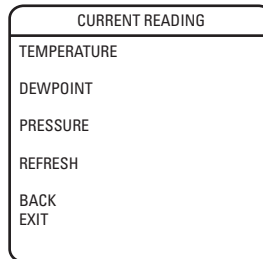

An up arrow indicates the reading is over the threshold. A down arrow indicates the reading is below the threshold.

The high temperature alert occurs if the temperature is above 60°C (140°F).

The low temperature alert occurs if the temperature is below -40°C (-40°F).

The high pressure alert occurs if the pressure is above 13 psig.

The low pressure alert occurs if the pressure is below 1 psig.

The dew point (high humidity) alert occurs if the difference between the temperature and the dew point is less than or equal to 3°C.

NOTE: The normal operating temperature inside the unit will be greater than the temperature outside the device due to the heat emitted by the device's electronics.

RESET ALERT

Reset alert clears the alert condition and removes the alert label from the monitor. The device automatically checks internal conditions 60 seconds after reset. If conditions are still unacceptable, the alert label reappears on the screen indicating further corrective action is required.

CLEAR

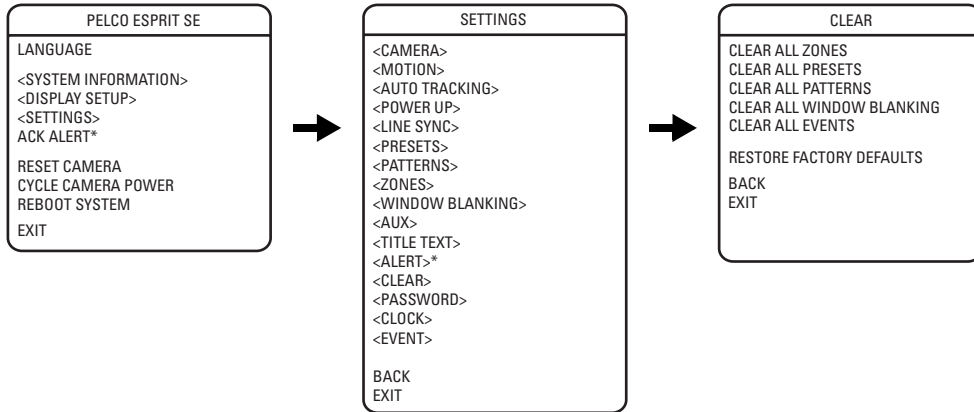

Use this setting to clear user-defined settings or return the device to factory default settings.

The following are the available settings:

ALL ZONES: Clears all zones. To clear a single zone, refer to *Zones* on page 43.

ALL PRESETS: Clears all presets. To clear a single preset, refer to *Presets* on page 37.

ALL PATTERNS: Clears all patterns. To clear a single pattern, refer to *Patterns* on page 42.

ALL WINDOW BLANKING: Clears all blanked windows. To clear a single blanked window, refer to *Window Blanking* on page 44.

CLEAR ALL EVENTS: Clears all events. To clear a single event, refer to on page 54.

RESTORE FACTORY DEFAULTS: Restores all camera settings to factory default settings.

PASSWORD

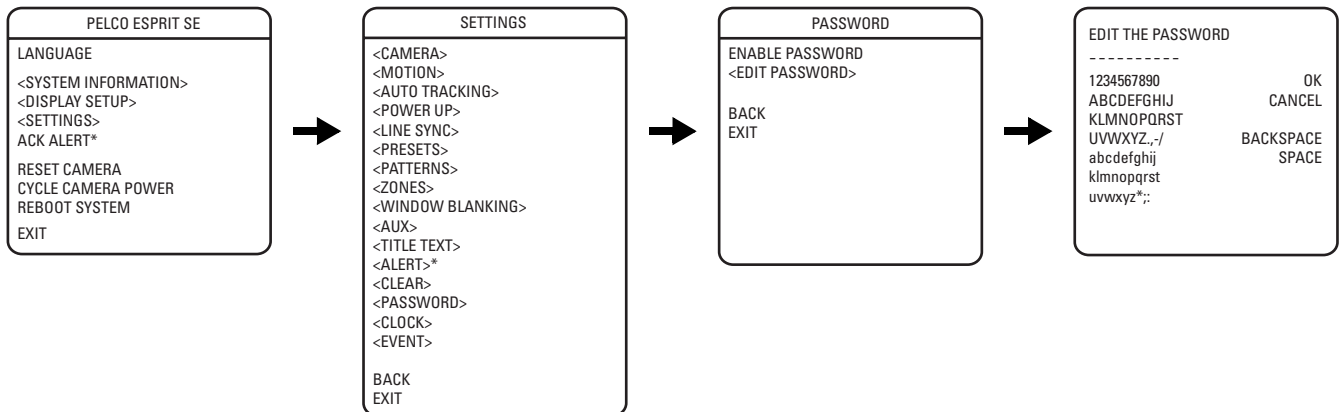

The device features password protection to prevent unauthorized changes to the device settings. An operator can open the System Information and Display Setup menus, but cannot access any of the settings menus.

Controller/keyboard commands cannot override password-protected settings. If a keyboard is used to set a preset, pattern, or zone, the Enter Password menu appears. The password must be entered before you can continue configuring the device.

At least one character must be entered to create a valid password.

*This setting applies to pressurized devices only.

CLOCK

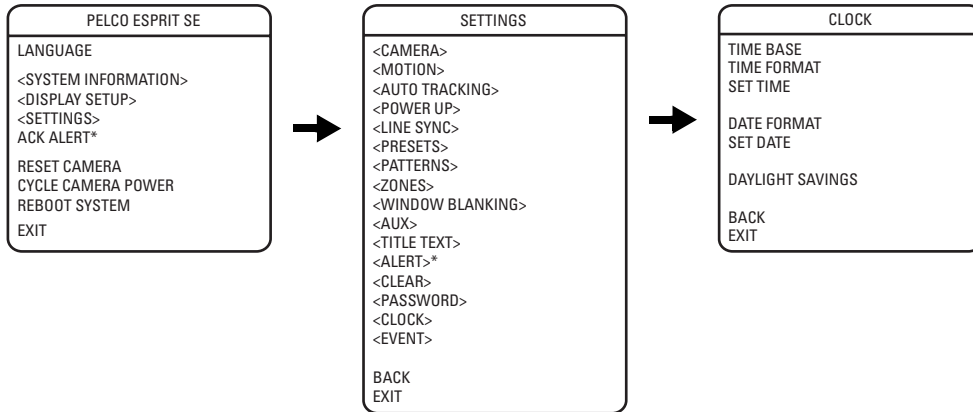

The clock is used to set the current date and time. The date and time set in the Clock menu is used to configure events. The date and time can also be displayed on the monitor when the menus are not being accessed.

To set the clock, do the following:

1. Use the joystick to position the cursor beside TIME BASE. Press Iris Open. The following are the settings for time base:
 - POWER LINE:** This is the most accurate time base and is the preferred selection in areas with a stable power line frequency.
 - INTERNAL CLOCK:** The internal clock should be used in areas where the power line frequency is not accurate.
 - a. Move the joystick up or down to view the selections.
 - b. Press Iris Open to select INTERNAL CLOCK or POWER LINE.
2. Use the joystick to position the cursor beside TIME FORMAT. Press Iris Open. Move the joystick up or down to view the selections. Select 12 HOUR or 24 HOUR, and then press Iris Open to confirm the time format.
3. Use the joystick to position the cursor beside SET TIME. Press Iris Open. Scroll through the hours until the desired time appears. Use the joystick to move the cursor to the right. Scroll through the minutes until the desired time appears. Press Iris Open to select the time.
4. Use the joystick to position the cursor beside DATE FORMAT. Press Iris Open. Move the joystick up or down to select MM/DD/YYYY or DD/MM/YYYY. Press Iris Open to confirm the date format.
5. Use the joystick to position the cursor beside SET DATE. Press Iris Open. Scroll through the days, months, and years until the desired number appears. Press Iris Open to select the date.
6. Use the joystick to position the cursor beside DAYLIGHT SAVINGS. Press Iris Open. The following are the settings for daylight savings:
 - OFF:** Daylight saving time will be turned off.
 - FIXED DATE:** Daylight saving time occurs on the same date each year.
 - RELATIVE DATE:** Daylight saving time occurs on a different date each year, such as the first Sunday in April.

*This setting applies to pressurized devices only.

7. If FIXED DATE was selected, the following information appears:

CLOCK	
TIME BASE	INTERNAL CLOCK
TIME FORMAT	12 HOUR
SET TIME	00:00 AM
DATE FORMAT	MM/DD/YYYY
SET DATE	00/00/0000
DAYLIGHT SAVINGS	FIXED DATE
TIME SHIFT	1 HOUR
START DATE	
MONTH	MARCH
DAY	1
START TIME	02:00 AM
END DATE	
MONTH	NOVEMBER
DAY	1
END TIME	02:00 AM
BACK	
EXIT	

- Use the joystick to position the cursor beside TIME SHIFT. Press Iris Open. Scroll through the options until the desired selection appears. Press Iris Open to select the time shift.
- Use the joystick to position the cursor beside the start date MONTH. Press Iris Open. Scroll through the options until the desired month appears. Press Iris Open to select the month.
- Use the joystick to position the cursor beside the start date DAY. Press Iris Open. Scroll through the options until the desired date appears. Press Iris Open to select the day.
- Use the joystick to position the cursor beside START TIME. Press Iris Open. Scroll through the hours until the desired time appears. Use the joystick to move the cursor to the right. Scroll through the minutes until the desired time appears. Press Iris Open to select the start time.
- Repeat steps b through d for the ending date and time.

8. If RELATIVE DATE was selected, the following information appears:

CLOCK	
TIME BASE	INTERNAL CLOCK
TIME FORMAT	12 HOUR
SET TIME	00:00 AM
DATE FORMAT	MM/DD/YYYY
SET DATE	00/00/0000
DAYLIGHT SAVINGS	RELATIVE DATE
TIME SHIFT	1 HOUR
START DATE	
MONTH	MARCH
WEEK	2ND
DAY	MONDAY
START TIME	02:00 AM
END DATE	
MONTH	NOVEMBER
WEEK	1ST
DAY	MONDAY
END TIME	02:00 AM
BACK	
EXIT	

Follow the instructions in step 7 for FIXED DATE, adding WEEK.

EVENT

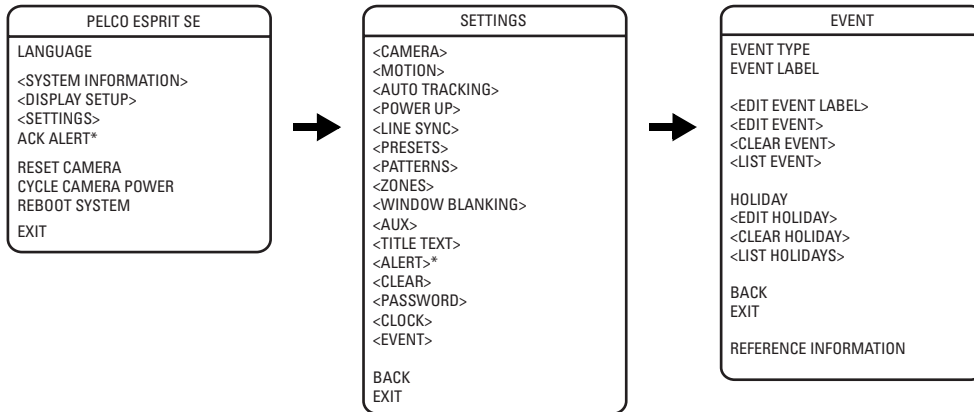

An event is a preconfigured camera, park, scan, preset, pattern, window blanking, alarm, or auxiliary function that can be performed automatically at a specific date and time.

For example, suppose a camera is set to run in a continuous pattern that scans a parking lot during business hours Monday through Friday. On Saturday and Sunday the camera needs to stop running the pattern and observe a gate. First, configure a preset to set the camera to observe the gate. Second, schedule an event to activate the preset on the weekends. Finally, a second, separate event must be scheduled to end the first event and allow the camera to return to the pattern on Monday.

NOTE: Events do not have a selectable duration. A second event must be scheduled to end a previous event.

Events can be configured from the Preset, Pattern, Window Blanking, or Aux menus, or they can be configured from the Event menu. Events are managed individually or as a group from the Event menu.

EVENT TYPE

Any of the available event types can be selected from this menu, or you may select ALL EVENTS to view and manage the events as a group. The following are the settings for event type:

SCAN: A scan event executes a specified scan (random, auto, or frame scan) using the limit stops and scan speed defined in the Motion menu. Refer to *Motion Settings* on page 32.

PARK: A park event executes the user-defined park action as specified in the Motion menu. Refer to *Park Action* on page 32.

WINDOW BLANKING: A window blanking event activates or deactivates a previously defined window blank. The window blank remains activated or deactivated until another configured event changes the state of the window or you modify it through the Window Blanking menu. Refer to *Window Blanking* on page 44.

AUX: An auxiliary event turns on/off an auxiliary output when the event triggers. Refer to *Aux* on page 47.

PATTERN: A pattern event starts a previously defined pattern when the event is triggered. Refer to *Patterns* on page 42.

CAMERA: A camera event assigns the camera settings of a preset to the current camera settings located in the Camera menu. Refer to *Camera* on page 26. The preset that is referenced by the event must be defined prior to setting up a camera event.

For the camera event to function, the referenced preset must have Custom Camera Settings activated. Refer to *Presets* on page 37.

PRESET: A preset event executes a previously defined preset when the event is triggered. Refer to *Presets* on page 37.

NOTES:

- If you have camera settings defined in the Camera menu that you wish to restore following a camera event which overwrites those settings, you must save the original settings as a separate preset prior to the camera event being triggered. You can then set a second camera event to call the preset that has the original settings saved. Camera settings can also be changed manually from the Camera menu following the original camera event.
- The event type cannot be changed if you are accessing it through the Edit Schedule option from the Preset, Pattern, Window Blanking, or Aux menu.

*This setting applies to pressurized devices only.

EVENT LABEL

Set the event label to NEW to create a new event.

Use the following steps to manage an existing event.

1. Use the joystick to position the cursor beside EVENT LABEL. Press Iris Open.
2. Move the joystick up or down to scroll through the events. Press Iris Open to enter the selection.

As you scroll through the events, the reference information at the bottom of the screen displays the corresponding details for each event. To view a list of all events and their details, refer to *List Event* on page 56.

EDIT EVENT LABEL

After an event is configured, the label can be changed using the following steps:

1. Use the joystick to position the cursor beside EDIT EVENT LABEL.
2. Press Iris Open. The following information appears:

EDIT EVENT LABEL	
EVENT 1	
1234567890	OK
ABCDEFGHIJ	CANCEL
KLMNOPQRST	
UVWXYZ,-./	BACKSPACE
abcdefghijkl	SPACE
klmnopqrst	
uvwxyz#&.*	

3. Use the joystick to position the cursor beside a character. Press Iris Open to enter the selection. To clear a character, position the cursor beside BACKSPACE, and then press Iris Open.
4. When the label is completed, move the cursor to OK. Press Iris Open to return to the Edit Schedule menu.

After an event is labeled, the label will be displayed when the event is activated according to the display setup values for this label. Refer to *Display Setup* on page 24 for instructions on how to change the way a label is displayed on the monitor.

EDIT EVENT

Use the following steps to edit an event.

1. Use the joystick to position the cursor beside EDIT EVENT.
2. Press Iris Open. The following information appears:

EDIT EVENT	
EVENT LABEL	EVENT 1
EVENT ACTIVE	NO
EVENT TIME	12:00 AM
EVENT OCCURS	
SUNDAY	OFF
MONDAY	OFF
TUESDAY	OFF
WEDNESDAY	OFF
THURSDAY	OFF
FRIDAY	OFF
SATURDAY	OFF
HOLIDAY	SKIP HOLIDAYS
EVENT TYPE	PRESET
NUMBER	1
BACK	
EXIT	

- a. Use the joystick to position the cursor beside EVENT ACTIVE. Press Iris Open. Scroll to select NO to leave the event inactive or YES to activate the event. Press Iris Open to confirm the selection.
- b. Use the joystick to position the cursor beside EVENT TIME. Press Iris Open. Scroll through the hours until the desired time appears. Use the joystick to move the cursor to the right. Scroll through the minutes until the desired time appears. Press Iris Open to select the time.
- c. Use the joystick to position the cursor beside SUNDAY. Press Iris Open. The available options are OFF and ON. Press Iris Open to confirm the selection.

- d. Follow the instructions in the previous step for the remaining days of the week.
- e. Use the joystick to position the cursor beside HOLIDAY. Press Iris Open. The following are the holiday settings:

SKIP HOLIDAYS: The event will not occur on a day of the week for which it is set if that date is in the list of holidays.

ON: The event will activate on holidays that are set in the Event menu, in addition to its normally scheduled days of the week.

OFF: The event only occurs on the days of the week that it is scheduled; holidays have no effect on the event.

CLEAR EVENT

To clear an event:

1. Use the joystick to position the cursor beside CLEAR EVENT.
2. Press Iris Open.
3. Follow the directions displayed on the monitor.

LIST EVENT

To list events:

1. Use the joystick to position the cursor beside LIST EVENT.
2. Press Iris Open.
3. All configured events will be listed.

HOLIDAY

Use the following steps to create a new holiday.

1. Use the joystick to position the cursor beside HOLIDAY. Press Iris Open.
2. Move the joystick up or down to scroll through the options. If no holidays were created in the past, NEW is the only selectable option. Press Iris Open to select NEW.
3. Proceed to *Edit Holiday* on page 56.

Use the following steps to manage an existing holiday.

1. Use the joystick to position the cursor beside HOLIDAY. Press Iris Open.
2. Move the joystick up or down to scroll through the holidays. Press Iris Open to enter the selection.
3. Proceed to *Edit Holiday* on page 56.

NOTE: Holidays cannot be changed through the Edit Schedule option from the Preset, Pattern, Window Blanking, or Aux menus.

EDIT HOLIDAY

Use the following steps to edit a holiday:

1. Use the joystick to position the cursor beside EDIT EVENT LABEL.
2. Press Iris Open.
3. Use the joystick to position the cursor beside OCCURRENCE. Press Iris Open. The following are the settings for Occurrence:

FIXED DATE: The holiday occurs on the same date each year.

RELATIVE DATE: The holiday occurs on a different date each year, such as the third Sunday in April.

4. If FIXED DATE was selected as the occurrence, the following information appears:

EDIT HOLIDAY	
OCCURRENCE	FIXED DATE
MONTH	JANUARY
DAY	1
BACK	
EXIT	

- a. Use the joystick to position the cursor beside MONTH. Press Iris Open. Scroll through the options until the desired month appears. Press Iris Open to select the month.
 - b. Use the joystick to position the cursor beside DAY. Press Iris Open. Scroll through the options until the desired date appears. Press Iris Open to select the day.
5. If RELATIVE DATE was selected as the occurrence:
- a. Use the joystick to position the cursor beside MONTH. Press Iris Open. Scroll through the options until the desired month appears. Press Iris Open to select the month.
 - b. Use the joystick to position the cursor beside WEEK. Press Iris Open. Scroll through the options until the desired week appears. Press Iris Open to select the week.
 - c. Use the joystick to position the cursor beside DAY. Press Iris Open. Scroll through the options until the desired day of the week appears. Press Iris Open to select the day.

CLEAR HOLIDAY

To clear a holiday:

1. Use the joystick to position the cursor beside CLEAR HOLIDAY.
2. Press Iris Open.
3. Follow the directions displayed on the monitor.

LIST HOLIDAYS

To list events:

1. Use the joystick to position the cursor beside LIST HOLIDAYS.
2. Press Iris Open.
3. All configured holidays will be listed.

SCHEDULED EVENTS

Use this page to record scheduled events.

EVENT NUMBER	EVENT TYPE	LABEL	TIME	OCCURS	HOLIDAY
Example: 1	Preset	Weekend	11:00 AM	Sat–Sun	Skips Holidays

Description: Camera focuses on gate on weekends when the office is closed.

Reset, Cycle Power, Reboot

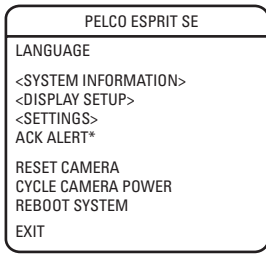

RESET CAMERA

Use this function to reset all camera settings to factory default parameters.

CYCLE CAMERA POWER

If the camera is not operating or if you lose camera control, cycle camera power. Cycling camera power resets the camera but does not change any saved camera settings.

REBOOT DEVICE

Reboot the device if it is not operating or if there is no control. Rebooting the device will cycle power without changing the configured settings.

Software/Language File Upload

The RJ-45 data port of the device allows access for on-site setup, testing, and uploading of revised operating software and language files. A Pelco field service tool is required to perform these operations. Field service tools include Pelco's remote data port box (IPS-RDPE-2) and remote monitor cable (IPS-CABLE).

For instructions on how to upload revised operating software and language files refer to the Installation/Operation manual supplied with the field service tool.

NOTE: Perform software uploads only when necessary. Software uploads do not need to be performed if the device is operating properly.

During a software/language file upload, a progress bar will appear indicating that data is being transferred to the device. The default setting for data transmission is 115.2 KB per second. Noisy and long-run connections will slow the transmission rate.

Troubleshooting

Symptom: Device does not operate

1. Check device input voltage.
2. The Esprit SE is protected by a resettable overcurrent protective device located in the transformer module. Whenever a fault condition is experienced in the system causing excessive current flow through the protective device, a change occurs that will prevent current flow. The protective device will remain in this state as long as power is applied and the system fault remains. The protective device will reset itself after power has been removed for a few minutes and will operate normally when the system fault has been repaired.
3. Check the camera and lens power connections and video BNC connections.

Symptom: No control/sluggish control (Coaxitron)

1. Check for correct type and length of coaxial cable.
2. Check for correct coaxial termination (refer to the controller manual to determine proper termination of video input). Normal load termination is 75 ohms. When looping through VCRs or multiplexers, make sure the signal is terminated at the end device. Some termination symptoms and problems are listed below.

Symptom	Problem
Extremely bright video	No termination or high resistance
Over contrast or contrast level of monitor needs to be increased to maximum for a good video image	Double termination (37.5 ohms)

3. If pan/tilt operation is sluggish, check the controller manual to make sure the control signal is set in the extended mode, not standard mode.
4. Check that the video is terminated.

Symptom: No control (RS-422)

1. Check for correct cable type and length. The maximum cable distance for RS-422 communication over 24-gauge wire is 4,000 feet (1,219 m). Pelco recommends using shielded twisted pairs, such as Belden 9843 or similar cable, that meets or exceeds the basic requirements for EIA RS-422 or RS-485 applications.
2. Check for correct wire connections between transmitting device (such as the CM6700 Series matrix system) and Esprit SE receiver. Correct connections are from the transmitting device TX+ to Esprit SE RX+ and from the transmitting device TX- to Esprit SE RX-.
3. Check for correct DIP switch settings.

Symptom: Ground loops

Ground loops are indicated by seeing 60 Hz noise on the video.

1. Check for resistance between the grounds of the keyboard and the device. Ideally, there should be zero ohms.
2. Remove the coaxial BNC connector and check for voltage between the BNC shield of the controller and the BNC shield of the device. No voltage should be detected.

It is recommended that a Pelco GIT100 ground isolation transformer be installed to eliminate the above problems.

Symptom: No video or poor video

1. Check the video and power connections to the camera.
2. Check for power to the camera from the Esprit SE camera power output.
3. Check all coaxial BNC connectors from the camera to the monitor.
4. Make sure the controller is set for the correct camera-to-monitor viewing combination; for example, Camera 1 to Monitor 1. Refer to the controller manual for information.
5. Check for normal load termination of 75 ohms. When looping through VCRs or multiplexers, make sure the signal is terminated at the end device. Some termination symptoms and problems are listed below.

Symptom	Problem
Extremely bright video	No termination or high resistance
Over contrast or contrast level of monitor needs to be increased to maximum for a good video image	Double termination (37.5 ohms)

Symptom: Wiper does not work with Genex Multiplexer in Track Main mode

If you have a Genex®/KBD4000/Esprit SE with wiper combination, you must perform the following steps to make the wiper function when Genex is in Track Main mode:

1. Call the spot monitor.
2. Call the camera.
3. Press the auxiliary ON key.

MAINTENANCE

Clean the enclosure window periodically with a mild non-abrasive detergent in water and a soft cloth to help maintain picture clarity.

If operating problems are experienced with the device, refer to *Troubleshooting* on page 61.

The pan/tilt is IP 66 and NEMA 4X rated. The pan/tilt left side cover must be removed to gain access to the DIP switches. When the cover is correctly reinstalled, the rating will remain in effect.

If the window wiper assembly is installed, replace worn or deteriorated wiper blades immediately. At a minimum, replace wiper blade once a year.

To order replacement wiper blades or if further maintenance is required, contact Pelco's Customer Service Department for assistance. Refer to the *Product Warranty and Return Information*.

NOTE: The device contains no user-serviceable parts. If there is a problem with your device, it must be returned to Pelco for servicing.

Specifications

ELECTRICAL

Input Voltage	24, 120, or 230 VAC, 50/60 Hz; switch selectable for 120/230 VAC inputs; reset feature enables when power becomes unstable or interrupted
Power Requirements	Maximum power consumption is 70 VA per device
Heater and Defroster	Thermostatically controlled heater consumes 10 W; cycles on at 5°C (40°F) and off at 16°C (60°F)
Defogger	The window defogger consumes 3 W; cycles on at 21°C (70°F) and off at 29°C (85°F)
Electrical Connections	2 power source connections made at mount location with wire splices and 1 ground wire splice; 1 BNC receptacle and 4 wire splices at mount location for RS-422 Pelco D and Pelco P protocols; 2 wire splices for open collector auxiliary output
Aux 2	Open collector output with 2-second activation; connected relay must require no more than 32 VDC and 40 mA to energize relay coil; wire length between Esprit SE and relay must be less than 30 m (100 ft)

MECHANICAL

Pan Movement	360° continuous pan rotation
Vertical Tilt	Unobstructed +36° to -85°
Variable Pan/Tilt Speed	
Pan	0.1° to 40°/sec variable-speed operation, 100°/sec turbo
Tilt	0.1° to 30°/sec variable-speed operation
Preset Speeds	
Pan	100°/sec
Tilt	30°/sec
Camera Mounting	Integrated camera sled assembly
Latches	1 link-lock, No. 3 stainless-steel latch; can be secured with padlock (not supplied)

CAMERAS

Scanning System	2:1 interlace/1:1 progressive (user-selectable)
Image Sensor	1/4-inch CCD
Effective Pixels	
NTSC	768 (H) x 494 (V)
PAL	752 (H) x 582 (V)
Horizontal Resolution	>540 TV lines
Focal Length	3.3 ~ 119 mm optical
Zoom Ratio	36X optical zoom, 12X digital zoom
Digital Slow Shutter	Auto/manual speed selection
Horizontal Angle of View	57.2° at 3.3 mm wide zoom; 1.7° at 119 mm telephoto zoom
Focus	Automatic with manual override
Maximum Sensitivity at 35 IRE	
NTSC	0.02 lux at 1/2 sec shutter speed 0.55 lux at 1/60 sec shutter speed (color) 0.018 lux at 1/2 sec shutter speed (color) 0.00018 lux at 1/2 sec shutter speed (B-W)
PAL	0.02 lux at 1/1.5 sec shutter speed 0.45 lux at 1/50 sec shutter speed (color) 0.015 lux at 1/1.5 sec shutter speed (color) 0.00015 lux at 1/1.5 sec shutter speed (B-W)
Synchronization System	AC line lock, phase adjustable through remote control, V-Sync*
White Balance	Automatic with manual override*
Shutter Speed	1/2 to 1/30,000 (NTSC) 1/1.5 to 1/30,000 (PAL)
Iris Control	Automatic with manual override*
Gain Control	Automatic/OFF*
Video Output	1 Vp-p, 75 ohms
Signal-to-Noise Ratio	50 dB

GENERAL

Construction	Die-cast, extruded and sheet aluminum; stainless steel hardware	
System	Aluminum	
EWM Wall Mount	Aluminum	
EPP Pedestal Adapter	Aluminum	
Finish	Gray polyester powder coat, anodized	
System	Gray polyester powder coat	
EWM Wall Mount	Gray polyester powder coat	
EPP Pedestal Adapter	Gray polyester powder coat	
Viewing Window	5.84 mm (0.23-inch) thick, optically clear, polycarbonate with proprietary impact resistant UV rated coating	
Window Viewing Area	5 cm (2-inch) diameter	
Operating Temperature	-45° to 50°C (-50° to 122°F) for sustained system operation or 60°C (140°F) absolute maximum; within two hours after power-up, the entire unit can de-ice and be operational from a temperature of -25°C (-13°F)	
Operating Environment	Will remain operational in 145 kph (90 mph) wind conditions; withstands 209 kph (130 mph)	
Weight	<u>With Pedestal Adapter</u>	<u>With Wall Mount</u>
Standard with IOP	9.0 kg (20 lb)	9.9 kg (22 lb)
With Wiper and IOP	9.5 kg (21 lb)	10.4 kg (23 lb)

*Manual control of camera setup functions is possible with CM6700, CM8500, CM9500, CM9760 and MPT9500 controllers, but not with CM7500, MPT9000 or KBD9000 controllers.



VALUES IN PARENTHESES ARE INCHES; ALL OTHERS ARE CENTIMETERS.

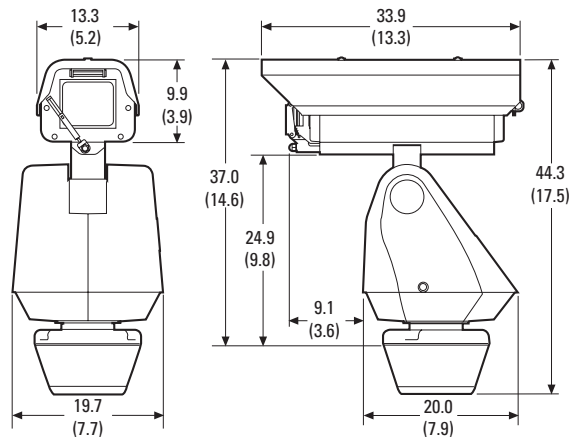

Appendix A

NOTE: The device will sense and automatically select input from Coaxitron control signals in either the standard or extended mode; therefore, the DIP switch settings have no effect on Coaxitron control signals.

SWITCH SETTINGS

Before installing the device, you must configure the receiver address, termination, and baud setting. The DIP switches used to configure these settings are located on the base of the device.

Figure 15 shows the default settings for the DIP switches. Switch SW1-1 (SW1, switch 1) is set to the ON position; all other switches are set to the OFF position.

Refer to the following sections to set the address, termination, and baud settings for the device.

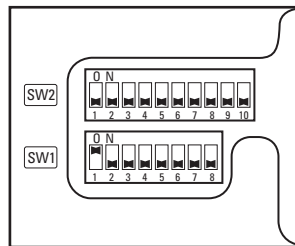

Figure 15. Default Switch Settings

SW1: RECEIVER ADDRESS

Set the SW1 switches for the address of the device. The following information is required to set the device address:

Pelco P-type control: The default address is 2. Refer to Table E on page 67 for address settings that use Pelco P-type control. The maximum number of receivers is 32.

Pelco D-type control: The default address is 1. Refer to Table F on page 68 for address settings that use Pelco D-type control. The maximum number of receivers is 254.

SW2 SWITCH 1: AD-32 PRESET SYSTEM

SW2-1 should be set to the ON position if an AD-32 controller and Pelco's TXB-AD translator board are used to control the device.

SW2 SWITCH 2: CM9502 SETTING

If a CM9502 matrix system is used with the device, set SW2-2 to the ON position.

SW2 SWITCH 3: CONTROL SYSTEM COMPATIBILITY

Coaxial Control Systems

Although Esprit SE devices can operate with coaxial control systems from many manufacturers, the device is designed for optimal performance with Pelco Coaxitron® control products within the length specified for coaxial cable.

To compensate for coaxial control systems from other manufacturers, Pelco has provided DIP switch SW2-3. Setting SW2-3 to the ON position may improve camera control with these control systems.

If you are using a Pelco Coaxitron controller, leave SW2-3 in the default OFF position.

NOTE: In some configurations, Pelco CM9502 Series matrix systems use nonstandard Coaxitron commands for functions like pattern playback. If you experience problems with these functions, set SW2-3 to the ON position.

Pelco P Protocol Control Systems

To compensate for Pelco P protocol control systems from other manufacturers, set SW2-3 to the ON position. This may improve camera control with some of these control systems.

SW2 SWITCHES 4 AND 5: SERIAL PORT SETTINGS

RS-422 Setting (Default)

SW2-4 and SW2-5 should both be set to the OFF position for RS-422 setting.

For control, only two wires should be connected to the RX- and RX+ connectors on the circuit board inside the back box. For bidirectional control, four wires should be connected to the RX-, RX+, TX-, and TX+ connectors on the circuit board inside the back box.

RS-485, 4-Wire Setting

SW2-4 should be set to OFF and SW2-5 should be set to ON if a 4-wire serial port connection is used with RS-485.

NOTE: This setting is most commonly used with Pelco Endura® systems.

RS-485, 2-Wire Setting

SW2-4 and SW2-5 should both be set to the ON position if a 2-wire serial port connection is used with RS-485.

This setting is used to allow the device to transmit and receive commands on the same pair of wires. Only two wires should be connected to the RX- and RX+ connectors on the circuit board inside the back box.

SW2 SWITCHES 6 TO 8: BAUD SETTINGS

Pelco D-type controllers are set for 2400 baud. The default setting for the device is 2400 baud. If you are using a Pelco D-type controller, do not reset SW2 switches 1 to 3 or SW2 switches 6 to 8.

Pelco P-type controllers can operate at 2400, 4800, and 9600 baud. Set the SW2 switches (6, 7, and 8), located on the base of the device, to the same baud as the Pelco P-type controller.

Table D. Baud Settings

Switch Number	SW2-6	SW2-7	SW2-8
2400 Baud (default for Pelco D-type control)	Off	Off	Off
4800 Baud (default for Pelco P-type control)	On	Off	Off
9600 Baud	Off	On	Off

SW2 Switch 9: Coaxial

SW2-9 should be set to the OFF position (default) if you are using coaxial cable.

SW2 Switch 10: Termination Setting

When connecting more than one device to a single controller, terminate the unit farthest from the controller. Termination is only required for the last device in the series.

The device is shipped from the factory in the unterminated (OFF) position. To terminate the device, set SW2-10 to the ON position.

NOTE: Termination is not required for Coaxitron control.

Appendix B

NOTE: The device will sense and automatically select input from Coaxitron control signals in either the standard or extended mode; therefore, the DIP switches settings have no effect on Coaxitron control signals.

Table E. Switch Settings for SW1 Pelco P-Type Control

ADDRESS	SWITCH SETTING							
	SW1-1	SW1-2	SW1-3	SW1-4	SW1-5	SW1-6	SW1-7	SW1-8
1	OFF	OFF	OFF	OFF	OFF	OFF	OFF	OFF
2	ON	OFF	OFF	OFF	OFF	OFF	OFF	OFF
3	OFF	ON	OFF	OFF	OFF	OFF	OFF	OFF
4	ON	ON	OFF	OFF	OFF	OFF	OFF	OFF
5	OFF	OFF	ON	OFF	OFF	OFF	OFF	OFF
6	ON	OFF	ON	OFF	OFF	OFF	OFF	OFF
7	OFF	ON	ON	OFF	OFF	OFF	OFF	OFF
8	ON	ON	ON	OFF	OFF	OFF	OFF	OFF
9	OFF	OFF	OFF	ON	OFF	OFF	OFF	OFF
10	ON	OFF	OFF	ON	OFF	OFF	OFF	OFF
11	OFF	ON	OFF	ON	OFF	OFF	OFF	OFF
12	ON	ON	OFF	ON	OFF	OFF	OFF	OFF
13	OFF	OFF	ON	ON	OFF	OFF	OFF	OFF
14	ON	OFF	ON	ON	OFF	OFF	OFF	OFF
15	OFF	ON	ON	ON	OFF	OFF	OFF	OFF
16	ON	ON	ON	ON	OFF	OFF	OFF	OFF
17	OFF	OFF	OFF	OFF	ON	OFF	OFF	OFF
18	ON	OFF	OFF	OFF	ON	OFF	OFF	OFF
19	OFF	ON	OFF	OFF	ON	OFF	OFF	OFF
20	ON	ON	OFF	OFF	ON	OFF	OFF	OFF
21	OFF	OFF	ON	OFF	ON	OFF	OFF	OFF
22	ON	OFF	ON	OFF	ON	OFF	OFF	OFF
23	OFF	ON	ON	OFF	ON	OFF	OFF	OFF
24	ON	ON	ON	OFF	ON	OFF	OFF	OFF
25	OFF	OFF	OFF	ON	ON	OFF	OFF	OFF
26	ON	OFF	OFF	ON	ON	OFF	OFF	OFF
27	OFF	ON	OFF	ON	ON	OFF	OFF	OFF
28	ON	ON	OFF	ON	ON	OFF	OFF	OFF
29	OFF	OFF	ON	ON	ON	OFF	OFF	OFF
30	ON	OFF	ON	ON	ON	OFF	OFF	OFF
31	OFF	ON	ON	ON	ON	OFF	OFF	OFF
32	ON	ON	ON	ON	ON	OFF	OFF	OFF

Table F. Switch Settings for SW1 Pelco D-Type Control (1 of 6)

ADDRESS	SWITCH SETTING							
	SW1-1	SW1-2	SW1-3	SW1-4	SW1-5	SW1-6	SW1-7	SW1-8
1	ON	OFF	OFF	OFF	OFF	OFF	OFF	OFF
2	OFF	ON	OFF	OFF	OFF	OFF	OFF	OFF
3	ON	ON	OFF	OFF	OFF	OFF	OFF	OFF
4	OFF	OFF	ON	OFF	OFF	OFF	OFF	OFF
5	ON	OFF	ON	OFF	OFF	OFF	OFF	OFF
6	OFF	ON	ON	OFF	OFF	OFF	OFF	OFF
7	ON	ON	ON	OFF	OFF	OFF	OFF	OFF
8	OFF	OFF	OFF	ON	OFF	OFF	OFF	OFF
9	ON	OFF	OFF	ON	OFF	OFF	OFF	OFF
10	OFF	ON	OFF	ON	OFF	OFF	OFF	OFF
11	ON	ON	OFF	ON	OFF	OFF	OFF	OFF
12	OFF	OFF	ON	ON	OFF	OFF	OFF	OFF
13	ON	OFF	ON	ON	OFF	OFF	OFF	OFF
14	OFF	ON	ON	ON	OFF	OFF	OFF	OFF
15	ON	ON	ON	ON	OFF	OFF	OFF	OFF
16	OFF	OFF	OFF	OFF	ON	OFF	OFF	OFF
17	ON	OFF	OFF	OFF	ON	OFF	OFF	OFF
18	OFF	ON	OFF	OFF	ON	OFF	OFF	OFF
19	ON	ON	OFF	OFF	ON	OFF	OFF	OFF
20	OFF	OFF	ON	OFF	ON	OFF	OFF	OFF
21	ON	OFF	ON	OFF	ON	OFF	OFF	OFF
22	OFF	ON	ON	OFF	ON	OFF	OFF	OFF
23	ON	ON	ON	OFF	ON	OFF	OFF	OFF
24	OFF	OFF	OFF	ON	ON	OFF	OFF	OFF
25	ON	OFF	OFF	ON	ON	OFF	OFF	OFF
26	OFF	ON	OFF	ON	ON	OFF	OFF	OFF
27	ON	ON	OFF	ON	ON	OFF	OFF	OFF
28	OFF	OFF	ON	ON	ON	OFF	OFF	OFF
29	ON	OFF	ON	ON	ON	OFF	OFF	OFF
30	OFF	ON	ON	ON	ON	OFF	OFF	OFF
31	ON	ON	ON	ON	ON	OFF	OFF	OFF
32	OFF	OFF	OFF	OFF	OFF	ON	OFF	OFF
33	ON	OFF	OFF	OFF	OFF	ON	OFF	OFF
34	OFF	ON	OFF	OFF	OFF	ON	OFF	OFF
35	ON	ON	OFF	OFF	OFF	ON	OFF	OFF
36	OFF	OFF	ON	OFF	OFF	ON	OFF	OFF
37	ON	OFF	ON	OFF	OFF	ON	OFF	OFF
38	OFF	ON	ON	OFF	OFF	ON	OFF	OFF
39	ON	ON	ON	OFF	OFF	ON	OFF	OFF
40	OFF	OFF	OFF	ON	OFF	ON	OFF	OFF
41	ON	OFF	OFF	ON	OFF	ON	OFF	OFF
42	OFF	ON	OFF	ON	OFF	ON	OFF	OFF
43	ON	ON	OFF	ON	OFF	ON	OFF	OFF
44	OFF	OFF	ON	ON	OFF	ON	OFF	OFF
45	ON	OFF	ON	ON	OFF	ON	OFF	OFF
46	OFF	ON	ON	ON	OFF	ON	OFF	OFF
47	ON	ON	ON	ON	OFF	ON	OFF	OFF
48	OFF	OFF	OFF	OFF	ON	ON	OFF	OFF
49	ON	OFF	OFF	OFF	ON	ON	OFF	OFF

Table F. Switch Settings for SW1 Pelco D-Type Control (2 of 6)

ADDRESS	SWITCH SETTING							
	SW1-1	SW1-2	SW1-3	SW1-4	SW1-5	SW1-6	SW1-7	SW1-8
50	OFF	ON	OFF	OFF	ON	ON	OFF	OFF
51	ON	ON	OFF	OFF	ON	ON	OFF	OFF
52	OFF	OFF	ON	OFF	ON	ON	OFF	OFF
53	ON	OFF	ON	OFF	ON	ON	OFF	OFF
54	OFF	ON	ON	OFF	ON	ON	OFF	OFF
55	ON	ON	ON	OFF	ON	ON	OFF	OFF
56	OFF	OFF	OFF	ON	ON	ON	OFF	OFF
57	ON	OFF	OFF	ON	ON	ON	OFF	OFF
58	OFF	ON	OFF	ON	ON	ON	OFF	OFF
59	ON	ON	OFF	ON	ON	ON	OFF	OFF
60	OFF	OFF	ON	ON	ON	ON	OFF	OFF
61	ON	OFF	ON	ON	ON	ON	OFF	OFF
62	OFF	ON	ON	ON	ON	ON	OFF	OFF
63	ON	ON	ON	ON	ON	ON	OFF	OFF
64	OFF	OFF	OFF	OFF	OFF	OFF	ON	OFF
65	ON	OFF	OFF	OFF	OFF	OFF	ON	OFF
66	OFF	ON	OFF	OFF	OFF	OFF	ON	OFF
67	ON	ON	OFF	OFF	OFF	OFF	ON	OFF
68	OFF	OFF	ON	OFF	OFF	OFF	ON	OFF
69	ON	OFF	ON	OFF	OFF	OFF	ON	OFF
70	OFF	ON	ON	OFF	OFF	OFF	ON	OFF
71	ON	ON	ON	OFF	OFF	OFF	ON	OFF
72	OFF	OFF	OFF	ON	OFF	OFF	ON	OFF
73	ON	OFF	OFF	ON	OFF	OFF	ON	OFF
74	OFF	ON	OFF	ON	OFF	OFF	ON	OFF
75	ON	ON	OFF	ON	OFF	OFF	ON	OFF
76	OFF	OFF	ON	ON	OFF	OFF	ON	OFF
77	ON	OFF	ON	ON	OFF	OFF	ON	OFF
78	OFF	ON	ON	ON	OFF	OFF	ON	OFF
79	ON	ON	ON	ON	OFF	OFF	ON	OFF
80	OFF	OFF	OFF	OFF	ON	OFF	ON	OFF
81	ON	OFF	OFF	OFF	ON	OFF	ON	OFF
82	OFF	ON	OFF	OFF	ON	OFF	ON	OFF
83	ON	ON	OFF	OFF	ON	OFF	ON	OFF
84	OFF	OFF	ON	OFF	ON	OFF	ON	OFF
85	ON	OFF	ON	OFF	ON	OFF	ON	OFF
86	OFF	ON	ON	OFF	ON	OFF	ON	OFF
87	ON	ON	ON	OFF	ON	OFF	ON	OFF
88	OFF	OFF	OFF	ON	ON	OFF	ON	OFF
89	ON	OFF	OFF	ON	ON	OFF	ON	OFF
90	OFF	ON	OFF	ON	ON	OFF	ON	OFF
91	ON	ON	OFF	ON	ON	OFF	ON	OFF
92	OFF	OFF	ON	ON	ON	OFF	ON	OFF
93	ON	OFF	ON	ON	ON	OFF	ON	OFF
94	OFF	ON	ON	ON	ON	OFF	ON	OFF
95	ON	ON	ON	ON	ON	OFF	ON	OFF
96	OFF	OFF	OFF	OFF	OFF	ON	ON	OFF
97	ON	OFF	OFF	OFF	OFF	ON	ON	OFF
98	OFF	ON	OFF	OFF	OFF	ON	ON	OFF

Table F. Switch Settings for SW1 Pelco D-Type Control (3 of 6)

ADDRESS	SWITCH SETTING							
	SW1-1	SW1-2	SW1-3	SW1-4	SW1-5	SW1-6	SW1-7	SW1-8
99	ON	ON	OFF	OFF	OFF	ON	ON	OFF
100	OFF	OFF	ON	OFF	OFF	ON	ON	OFF
101	ON	OFF	ON	OFF	OFF	ON	ON	OFF
102	OFF	ON	ON	OFF	OFF	ON	ON	OFF
103	ON	ON	ON	OFF	OFF	ON	ON	OFF
104	OFF	OFF	OFF	ON	OFF	ON	ON	OFF
105	ON	OFF	OFF	ON	OFF	ON	ON	OFF
106	OFF	ON	OFF	ON	OFF	ON	ON	OFF
107	ON	ON	OFF	ON	OFF	ON	ON	OFF
108	OFF	OFF	ON	ON	OFF	ON	ON	OFF
109	ON	OFF	ON	ON	OFF	ON	ON	OFF
110	OFF	ON	ON	ON	OFF	ON	ON	OFF
111	ON	ON	ON	ON	OFF	ON	ON	OFF
112	OFF	OFF	OFF	OFF	ON	ON	ON	OFF
113	ON	OFF	OFF	OFF	ON	ON	ON	OFF
114	OFF	ON	OFF	OFF	ON	ON	ON	OFF
115	ON	ON	OFF	OFF	ON	ON	ON	OFF
116	OFF	OFF	ON	OFF	ON	ON	ON	OFF
117	ON	OFF	ON	OFF	ON	ON	ON	OFF
118	OFF	ON	ON	OFF	ON	ON	ON	OFF
119	ON	ON	ON	OFF	ON	ON	ON	OFF
120	OFF	OFF	OFF	ON	ON	ON	ON	OFF
121	ON	OFF	OFF	ON	ON	ON	ON	OFF
122	OFF	ON	OFF	ON	ON	ON	ON	OFF
123	ON	ON	OFF	ON	ON	ON	ON	OFF
124	OFF	OFF	ON	ON	ON	ON	ON	OFF
125	ON	OFF	ON	ON	ON	ON	ON	OFF
126	OFF	ON	ON	ON	ON	ON	ON	OFF
127	ON	ON	ON	ON	ON	ON	ON	OFF
128	OFF	OFF	OFF	OFF	OFF	OFF	OFF	ON
129	ON	OFF	OFF	OFF	OFF	OFF	OFF	ON
130	OFF	ON	OFF	OFF	OFF	OFF	OFF	ON
131	ON	ON	OFF	OFF	OFF	OFF	OFF	ON
132	OFF	OFF	ON	OFF	OFF	OFF	OFF	ON
133	ON	OFF	ON	OFF	OFF	OFF	OFF	ON
134	OFF	ON	ON	OFF	OFF	OFF	OFF	ON
135	ON	ON	ON	OFF	OFF	OFF	OFF	ON
136	OFF	OFF	OFF	ON	OFF	OFF	OFF	ON
137	ON	OFF	OFF	ON	OFF	OFF	OFF	ON
138	OFF	ON	OFF	ON	OFF	OFF	OFF	ON
139	ON	ON	OFF	ON	OFF	OFF	OFF	ON
140	OFF	OFF	ON	ON	OFF	OFF	OFF	ON
141	ON	OFF	ON	ON	OFF	OFF	OFF	ON
142	OFF	ON	ON	ON	OFF	OFF	OFF	ON
143	ON	ON	ON	ON	OFF	OFF	OFF	ON
144	OFF	OFF	OFF	OFF	ON	OFF	OFF	ON
145	ON	OFF	OFF	OFF	ON	OFF	OFF	ON
146	OFF	ON	OFF	OFF	ON	OFF	OFF	ON
147	ON	ON	OFF	OFF	ON	OFF	OFF	ON

Table F. Switch Settings for SW1 Pelco D-Type Control (4 of 6)

ADDRESS	SWITCH SETTING							
	SW1-1	SW1-2	SW1-3	SW1-4	SW1-5	SW1-6	SW1-7	SW1-8
148	OFF	OFF	ON	OFF	ON	OFF	OFF	ON
149	ON	OFF	ON	OFF	ON	OFF	OFF	ON
150	OFF	ON	ON	OFF	ON	OFF	OFF	ON
151	ON	ON	ON	OFF	ON	OFF	OFF	ON
152	OFF	OFF	OFF	ON	ON	OFF	OFF	ON
153	ON	OFF	OFF	ON	ON	OFF	OFF	ON
154	OFF	ON	OFF	ON	ON	OFF	OFF	ON
155	ON	ON	OFF	ON	ON	OFF	OFF	ON
156	OFF	OFF	ON	ON	ON	OFF	OFF	ON
157	ON	OFF	ON	ON	ON	OFF	OFF	ON
158	OFF	ON	ON	ON	ON	OFF	OFF	ON
159	ON	ON	ON	ON	ON	OFF	OFF	ON
160	OFF	OFF	OFF	OFF	OFF	ON	OFF	ON
161	ON	OFF	OFF	OFF	OFF	ON	OFF	ON
162	OFF	ON	OFF	OFF	OFF	ON	OFF	ON
163	ON	ON	OFF	OFF	OFF	ON	OFF	ON
164	OFF	OFF	ON	OFF	OFF	ON	OFF	ON
165	ON	OFF	ON	OFF	OFF	ON	OFF	ON
166	OFF	ON	ON	OFF	OFF	ON	OFF	ON
167	ON	ON	ON	OFF	OFF	ON	OFF	ON
168	OFF	OFF	OFF	ON	OFF	ON	OFF	ON
169	ON	OFF	OFF	ON	OFF	ON	OFF	ON
170	OFF	ON	OFF	ON	OFF	ON	OFF	ON
171	ON	ON	OFF	ON	OFF	ON	OFF	ON
172	OFF	OFF	ON	ON	OFF	ON	OFF	ON
173	ON	OFF	ON	ON	OFF	ON	OFF	ON
174	OFF	ON	ON	ON	OFF	ON	OFF	ON
175	ON	ON	ON	ON	OFF	ON	OFF	ON
176	OFF	OFF	OFF	OFF	ON	ON	OFF	ON
177	ON	OFF	OFF	OFF	ON	ON	OFF	ON
178	OFF	ON	OFF	OFF	ON	ON	OFF	ON
179	ON	ON	OFF	OFF	ON	ON	OFF	ON
180	OFF	OFF	ON	OFF	ON	ON	OFF	ON
181	ON	OFF	ON	OFF	ON	ON	OFF	ON
182	OFF	ON	ON	OFF	ON	ON	OFF	ON
183	ON	ON	ON	OFF	ON	ON	OFF	ON
184	OFF	OFF	OFF	ON	ON	ON	OFF	ON
185	ON	OFF	OFF	ON	ON	ON	OFF	ON
186	OFF	ON	OFF	ON	ON	ON	OFF	ON
187	ON	ON	OFF	ON	ON	ON	OFF	ON
188	OFF	OFF	ON	ON	ON	ON	OFF	ON
189	ON	OFF	ON	ON	ON	ON	OFF	ON
190	OFF	ON	ON	ON	ON	ON	OFF	ON
191	ON	ON	ON	ON	ON	ON	OFF	ON
192	OFF	OFF	OFF	OFF	OFF	OFF	ON	ON
193	ON	OFF	OFF	OFF	OFF	OFF	ON	ON
194	OFF	ON	OFF	OFF	OFF	OFF	ON	ON
195	ON	ON	OFF	OFF	OFF	OFF	ON	ON
196	OFF	OFF	ON	OFF	OFF	OFF	ON	ON

Table F. Switch Settings for SW1 Pelco D-Type Control (5 of 6)

ADDRESS	SWITCH SETTING							
	SW1-1	SW1-2	SW1-3	SW1-4	SW1-5	SW1-6	SW1-7	SW1-8
197	ON	OFF	ON	OFF	OFF	OFF	ON	ON
198	OFF	ON	ON	OFF	OFF	OFF	ON	ON
199	ON	ON	ON	OFF	OFF	OFF	ON	ON
200	OFF	OFF	OFF	ON	OFF	OFF	ON	ON
201	ON	OFF	OFF	ON	OFF	OFF	ON	ON
202	OFF	ON	OFF	ON	OFF	OFF	ON	ON
203	ON	ON	OFF	ON	OFF	OFF	ON	ON
204	OFF	OFF	ON	ON	OFF	OFF	ON	ON
205	ON	OFF	ON	ON	OFF	OFF	ON	ON
206	OFF	ON	ON	ON	OFF	OFF	ON	ON
207	ON	ON	ON	ON	OFF	OFF	ON	ON
208	OFF	OFF	OFF	OFF	ON	OFF	ON	ON
209	ON	OFF	OFF	OFF	ON	OFF	ON	ON
210	OFF	ON	OFF	OFF	ON	OFF	ON	ON
211	ON	ON	OFF	OFF	ON	OFF	ON	ON
212	OFF	OFF	ON	OFF	ON	OFF	ON	ON
213	ON	OFF	ON	OFF	ON	OFF	ON	ON
214	OFF	ON	ON	OFF	ON	OFF	ON	ON
215	ON	ON	ON	OFF	ON	OFF	ON	ON
216	OFF	OFF	OFF	ON	ON	OFF	ON	ON
217	ON	OFF	OFF	ON	ON	OFF	ON	ON
218	OFF	ON	OFF	ON	ON	OFF	ON	ON
219	ON	ON	OFF	ON	ON	OFF	ON	ON
220	OFF	OFF	ON	ON	ON	OFF	ON	ON
221	ON	OFF	ON	ON	ON	OFF	ON	ON
222	OFF	ON	ON	ON	ON	OFF	ON	ON
223	ON	ON	ON	ON	ON	OFF	ON	ON
224	OFF	OFF	OFF	OFF	OFF	ON	ON	ON
225	ON	OFF	OFF	OFF	OFF	ON	ON	ON
226	OFF	ON	OFF	OFF	OFF	ON	ON	ON
227	ON	ON	OFF	OFF	OFF	ON	ON	ON
228	OFF	OFF	ON	OFF	OFF	ON	ON	ON
229	ON	OFF	ON	OFF	OFF	ON	ON	ON
230	OFF	ON	ON	OFF	OFF	ON	ON	ON
231	ON	ON	ON	OFF	OFF	ON	ON	ON
232	OFF	OFF	OFF	ON	OFF	ON	ON	ON
233	ON	OFF	OFF	ON	OFF	ON	ON	ON
234	OFF	ON	OFF	ON	OFF	ON	ON	ON
235	ON	ON	OFF	ON	OFF	ON	ON	ON
236	OFF	OFF	ON	ON	OFF	ON	ON	ON
237	ON	OFF	ON	ON	OFF	ON	ON	ON
238	OFF	ON	ON	ON	OFF	ON	ON	ON
239	ON	ON	ON	ON	OFF	ON	ON	ON
240	OFF	OFF	OFF	OFF	ON	ON	ON	ON
241	ON	OFF	OFF	OFF	ON	ON	ON	ON
242	OFF	ON	OFF	OFF	ON	ON	ON	ON
243	ON	ON	OFF	OFF	ON	ON	ON	ON
244	OFF	OFF	ON	OFF	ON	ON	ON	ON
245	ON	OFF	ON	OFF	ON	ON	ON	ON

Table F. Switch Settings for SW1 Pelco D-Type Control (6 of 6)

ADDRESS	SWITCH SETTING							
	SW1-1	SW1-2	SW1-3	SW1-4	SW1-5	SW1-6	SW1-7	SW1-8
246	OFF	ON	ON	OFF	ON	ON	ON	ON
247	ON	ON	ON	OFF	ON	ON	ON	ON
248	OFF	OFF	OFF	ON	ON	ON	ON	ON
249	ON	OFF	OFF	ON	ON	ON	ON	ON
250	OFF	ON	OFF	ON	ON	ON	ON	ON
251	ON	ON	OFF	ON	ON	ON	ON	ON
252	OFF	OFF	ON	ON	ON	ON	ON	ON
253	ON	OFF	ON	ON	ON	ON	ON	ON
254	OFF	ON	ON	ON	ON	ON	ON	ON

PRODUCT WARRANTY AND RETURN INFORMATION

WARRANTY

Pelco will repair or replace, without charge, any merchandise proved defective in material or workmanship **for a period of one year** after the date of shipment.

Exceptions to this warranty are as noted below:

- Five years:
 - Fiber optic products
 - Unshielded Twisted Pair (UTP) transmission products
 - CC3701H-2, CC3701H-2X, CC3751H-2, CC3651H-2X, MC3651H-2, and MC3651H-2X camera models
- Three years:
 - FD Series and BU Series analog camera models
 - Fixed network cameras and network dome cameras with Sarix® technology
 - Sarix thermal imaging products (TI and ESTI Series)
 - Fixed analog camera models (C20 Series, CCC1390H Series, C10DN Series, and C10CH Series)
 - EH1500 Series enclosures
 - Spectra® IV products (including Spectra IV IP)
 - Spectra HD dome products
 - Camclosure® IS Series integrated camera systems
 - DX Series video recorders (except DX9000 Series which is covered for a period of one year), DVR5100 Series digital video recorders, Digital Sentry® Series hardware products, DVX Series digital video recorders, and NVR300 Series network video recorders
 - Endura® Series distributed network-based video products
 - Genex® Series products (multiplexers, server, and keyboard)
 - PMCL200/300/400 Series LCD monitors
 - PMCL5xxF Series and PMCL5xxNB Series LCD monitors
- Two years:
 - Standard varifocal, fixed focal, and motorized zoom lenses
 - DF5/DF8 Series fixed dome products
 - Legacy® Series integrated positioning systems
 - Spectra III™, Spectra Mini, Spectra Mini IP, Esprit®, ExSite®, ExSite IP, and PS20 scanners, including when used in continuous motion applications
 - Esprit Ti and T12500 Series thermal imaging products
 - Esprit and WW5700 Series window wiper (excluding wiper blades)
 - CM6700/CM6800/CM9700 Series matrix
 - Digital Light Processing (DLP®) displays (except lamp and color wheel). The lamp and color wheel will be covered for a period of 90 days. The air filter is not covered under warranty.

- Six months:
 - All pan and tilts, scanners, or preset lenses used in continuous motion applications (preset scan, tour, and auto scan modes)

Pelco will warrant all replacement parts and repairs for 90 days from the date of Pelco shipment. All goods requiring warranty repair shall be sent freight prepaid to a Pelco designated location. Repairs made necessary by reason of misuse, alteration, normal wear, or accident are not covered under this warranty.

Pelco assumes no risk and shall be subject to no liability for damages or loss resulting from the specific use or application made of the Products. Pelco's liability for any claim, whether based on breach of contract, negligence, infringement of any rights of any party or product liability, relating to the Products shall not exceed the price paid by the Dealer to Pelco for such Products. In no event will Pelco be liable for any special, incidental, or consequential damages (including loss of use, loss of profit, and claims of third parties) however caused, whether by the negligence of Pelco or otherwise.

The above warranty provides the Dealer with specific legal rights. The Dealer may also have additional rights, which are subject to variation from state to state.

If a warranty repair is required, the Dealer must contact Pelco at (800) 289-9100 or (559) 292-1981 to obtain a Repair Authorization number (RA), and provide the following information:

1. Model and serial number
2. Date of shipment, P.O. number, sales order number, or Pelco invoice number
3. Details of the defect or problem

If there is a dispute regarding the warranty of a product that does not fall under the warranty conditions stated above, please include a written explanation with the product when returned.

Method of return shipment shall be the same or equal to the method by which the item was received by Pelco.

RETURNS

To expedite parts returned for repair or credit, please call Pelco at (800) 289-9100 or (559) 292-1981 to obtain an authorization number (CA number if returned for credit, and RA number if returned for repair) and designated return location.

All merchandise returned for credit may be subject to a 20 percent restocking and refurbishing charge.

Goods returned for repair or credit should be clearly identified with the assigned CA or RA number and freight should be prepaid.

Revised 1-12-12

 Green The materials used in the manufacture of this document and its components are compliant to the requirements of Directive 2002/95/EC.



This equipment contains electrical or electronic components that must be recycled properly to comply with Directive 2002/96/EC of the European Union regarding the disposal of waste electrical and electronic equipment (WEEE). Contact your local dealer for procedures for recycling this equipment.

REVISION HISTORY

Manual #	Date	Comments
C1323M	5/12	Original version.

Pelco, the Pelco logo, and other trademarks associated with Pelco products referred to in this publication are trademarks of Pelco, Inc. or its affiliates. All other product names and services are the property of their respective companies. Product specifications and availability are subject to change without notice.

© Copyright 2012, Pelco, Inc.
All rights reserved.



Pelco, Inc. 625 Alluvial Ave., Fresno, CA 93711 United States
USA & Canada Tel (800) 289-9100 Fax (800) 289-9150
International Tel +1 (559) 292-1981 Fax +1 (559) 348-1120

www.pelco.com