

GV-EFD270T 2MP H.265 Super Low Lux WDR Pro IR Mini Fixed IP Dome



- 1/2.8" progressive scan super low lux CMOS
 - Min. illumination at 0.004 lux
 - Dual streams from H.265, H.264 and MJPEG
 - Up to 30 fps at 1920 x 1080
 - Intelligent IR
 - Day and Night function (with removable IR-cut filter)
 - 2-axis mechanism (pan / tilt)
 - Wide Dynamic Range Pro (WDR Pro)
 - 3D noise reduction
 - Smart streaming
 - Defog
 - Motion detection
 - Tampering alarm
 - Text overlay
 - Privacy mask
 - IP address filtering
 - DC 12V / PoE (IEEE 802.3af)
 - Megapixel lens
 - Recording assigned by GV-Edge Recording Manager (Windows & Mac)
 - Supports iPhone, iPad, Android & 3GPP
 - 31 languages on Web interface
 - ONVIF (Profile S) conformant
- * Smart streaming requires either GV-DVR / NVR V8.7.0.0 or GV-VMS V16.10.3

Introduction

The Target Mini Fixed Dome is an indoor, fixed, mini-sized network camera equipped with a removable IR-cut filter and IR LEDs for day and night surveillance. Adjustable in 2 axes (pan and tilt), it offers an entry-level surveillance solution with all the essential features and excellent image quality. The camera supports H.265 video codec to achieve better compression ratio while maintaining high quality pictures at reduced network bandwidths. With the super low lux CMOS image sensor, the camera is capable of providing a color live view in near darkness.

Models

Model	Iris	Focal Length (mm)	Maximum Aperture	Image Format
GV-EFD270T-0F	Fixed	2.8	F/2.0	1/2.7"

Active Tampering Alarm

Tampered



Focus Change



Camera Shift

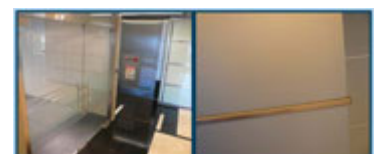

Dimensions

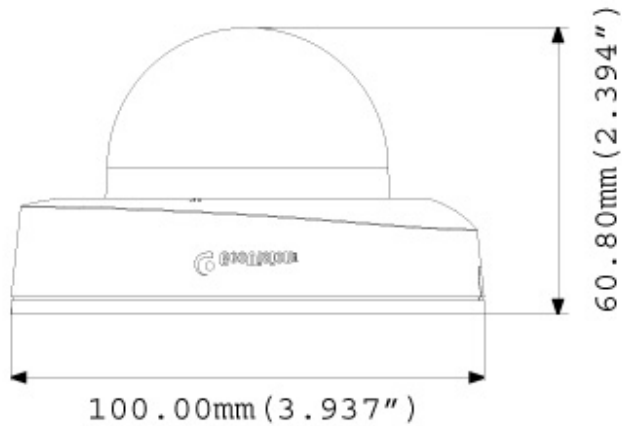

Specifications

Camera		GV-EFD270T-0F
Image Sensor		1/2.8" progressive scan super low lux CMOS
Picture Elements		1920 (H) x 1080 (V)
Minimum Illumination	Color	0.005 Lux
	B/W	0.004 Lux
	IR ON	0 Lux
Shutter Speed		Automatic, manual (1/5 ~ 1/16000 sec.)
White Balance		Automatic, manual (2800K ~ 8500K)
Gain Control		Automatic
S/N Ratio		56 dB
WDR		WDR Pro
Dynamic Range		Up to 130 dB
Lens		
Megapixel		Yes
Day/Night		Yes (with removable IR-cut filter)
Focal Length		2.8 mm
Lens Type		Fixed
Maximum Aperture		F/2.0
Mount		M12, Pitch 0.5 mm
Horizontal FOV		100°
Image Format		1/2.7"
Operation	Focus	Fixed
	Zoom	Fixed
	Iris	Fixed
IR LED Quantity		12 IR LEDs
Max. IR Distance		40 m (131 ft)
Operation		
Video Compression		H.265, H.264, MJPEG
Video Streaming		Stream 1 from H.265 or H.264 Stream 2 from H.265, H.264 or MJPEG
Frame Rate		50 Hz: 25 fps at 1920 x 1080 60 Hz: 30 fps at 1920 x 1080 * The frame rate and performance may vary depending on the number of connections and data bitrates (different scenes)
Image Setting		Brightness, Contrast, Saturation, Sharpness, Gamma, White Balance, Flicker-less, Image Orientation, Shutter Speed, Backlight Compensation, D/N Sensitivity, WDR, Defog, Low Lux Enhancement, Denoise, Metering

Audio Compression	G.711, AAC (Optional)
Audio Support	One-way audio
Sensor Input	1 input (Dry contact)
Alarm Output	1 digital output (200 mA 5V DC)

Video Resolution

Main Stream	4:3	1280 x 960, 640 x 480
	16:9	1920 x 1080 (Default), 1280 x 720, 640 x 360
	5:4	1280 x 1024, 640 x 512
Sub Stream	4:3	640 x 480, 320 x 240
	16:9	640 x 360 (Default), 448 x 256
	5:4	640 x 512, 320 x 256

Network

Interface	10/100 Ethernet
Ethernet Protocol	DHCP, DynDNS, FTP, HTTP, HTTPS, NTP, ONVIF (Profile S), QoS (DSCP), RTSP, SNMP, SMTP, TCP, UDP, UPnP, 3GPP/ISMA

Mechanical

Temperature Detector	Yes	
Camera Angle Adjustment	Pan	-45° ~ 45°
	Tilt	0° ~ 63°
Connectors	Power	2-pin terminal block, PoE
	Ethernet	Ethernet (10/100 Base-T), RJ-45 cable
	Audio	1 In (microphone, 3.5mm / 0.14")
	Local Storage	N/A
LED Indicator	4 LEDs: Link, ACT, Power, Status	

General

Environment Temperature	0 °C ~ 45 °C (32 °F ~ 113 °F)
Humidity	10% to 90% (no condensation)
Power Source	12V DC / PoE (IEEE 802.3af)
Max. Power Consumption	6.07 W
Dimension	∅ 100 x 60 mm (3.9" x 2.4")
Weight	148 g (0.33 lb)
Regulatory	CE, FCC, RCM, LVD, RoHS compliant

Power over Ethernet

PoE Standard	PoE (IEEE 802.3af Power over Ethernet / PD)
PoE Power Supply Type	End-span and Mid-span
PoE Power Output	Per Port 48V DC, 350 mA, Max. 15.4 watts

Web Interface

Installation Management	Web-based configuration
Maintenance	Firmware upgrade through Web Browser or Utility
Access from Web Browser	Camera Live View, Video Recording, Change Video Quality, Bandwidth Control, Image Snapshot, Audio, Picture in Picture, Picture and Picture, Privacy Mask, Text Overlay, Digital PTZ
Language	Arabic / Bulgarian / Czech / Danish / Dutch / English / Finnish / French / German / Greek / Hebrew / Hungarian / Indonesian / Italian / Japanese / Lithuanian / Norwegian / Persian / Polish / Portuguese / Romanian / Russian / Serbian / Simplified Chinese / Slovakian / Slovenian / Spanish / Swedish / Thai / Traditional Chinese / Turkish

Applications

Software Supported	GV-DVR / NVR (V8.7.3.0), GV-VMS (V16.11.0.0), GV-Control Center (V3.4.0.0), GV-Edge Recording Manager (V1.2.1.0), GV-Center V2 (V16.11.0.0), GV-Recording Server (V1.3.0.0), GV-Redundant / Failover Server (V1.1.0.0)
Smart Device Access	GV-Eye for iOS and Android
Live Viewing	Browser (IE, Chrome, Firefox, Safari), Mobile App
CMS Server support	GV-Control Center, GV-Center V2, GV-Vital Sign Monitor

Note:





1. It is required to apply patch files to all the supported software.
2. Specifications are subject to change without prior notice.

Packing List

- | | |
|--------------------------|-------------------|
| 1. H.265 Mini Fixed Dome | 5. Download Guide |
| 2. Screw x 2 | 6. Warranty Card |
| 3. Screw Anchor x 2 | |
| 4. Focus Adjustment Ring | |

Note: Power adapters can be purchased upon request.

Accessories

Model No./Name	Details
GV-Mount900 Wall Mount Bracket 	Dimensions: 154 x 108 x 50 mm (6.1" x 4.3" x 2") Weight: 240 g (0.53 lb)
GV-Mount910 Power Box Mount Bracket 	Dimensions: 112 x 98 x 7.5 mm (4.4" x 3.9" x 0.3") Weight: 105 g (0.23 lb)
GV-Mount913 Power Box Mount Bracket 	Dimensions: \varnothing 146 x 7.5 mm (\varnothing 5.7" x 0.3") Weight: 180 g (0.4 lb)
GV-Mount918 Wall Mount Bracket for MFD/MDR/EFD/EDR 	Dimensions: \varnothing 145 x 117 x 96 mm (\varnothing 5.71 x 4.60 x 3.78") Weight: 350 g (0.77 lb)
GV-PA191 PoE Adapter 	Dimensions (H x W x D): 43 x 69 x 40 mm (1.69" x 2.72" x 1.57") Weight: 130 g (0.29 lb)
Power Adapter	Contact our sales representatives for the countries and areas supported.
GV-PoE Switch	The GV-PoE Switch is designed to provide power along with network connection for IP devices. The GV-PoE Switch is available in various models with different numbers and types of ports.